



# The Canadian Oxford Picture Dictionary



HSIAO-YIING LIU

English/Chinese Edition

# The Canadian Oxford Picture Dictionary

E.C. Parnwell

Canadian adaptation by Maggie Grennan

*Translated by Hsiao-yiing Liu*

本书由canada.bbs001.com网友zmzy2000推荐、扫描、整理、共享。

本意是提供给那些即将移民而无法购买此书的朋友，供他们作为出发前的准备工具之一。

希望已经移民的朋友尊重此书版权，去购买原版正品。

*Illustrations by:*

Ray Burns

Bob Giuliani

Laura Hartman Maestro

Pamela Johnson

M. Chandler Martylewski

Melodye Rosales

Raymond Skibinski

Joel Snyder

个人推荐意见：

高中英语老师曾经对我们说：好字典，只要一本最好的就够了。之后的若干年我都一直没有体会他的话。直至来到加拿大之后，才发现他的话太正确了。金山词霸融会了几十部字典，但都是从来没摸过枪的瞎子，一个神枪手（牛津、朗文等）都没有。

来到加拿大，发现牛津比那些乌七八糟的词典好太多了。例如加拿大所有人都把一元硬币称为loonie，两元硬币称为toonie，可金山词霸查不到。推荐大家买两本字典，一本是

**Oxford University Press**

是此书，需要每页纸都背下来，另外是The Canadian Oxford Dictionary，很厚，用来查。

且建议大家6、7月份（学生放假）去买，会打5折。

*The Canadian Oxford Picture Dictionary* contextually illustrates over 2,400 words. The book is a unique language learning tool for students of English. It provides students with a glance at Canadian lifestyle, as well as a compendium of useful vocabulary.

The *Dictionary* is organized thematically, beginning with topics that are most useful for the "survival" needs of students in a bilingual country. The topics move on to those of a more general nature, including those that may be used in content area classes in schools in Canada. However, pages may be used at random, depending on the students' particular needs. The book need not be taught in order.

The words depicted are those most useful for students needing basic English skills. The most common name of any given item was used for simplicity.

*The Canadian Oxford Picture Dictionary* contextualizes vocabulary whenever possible, thus making the language learner's task a bit easier. Verbs have been included on separate pages, but within a topic area where they are most likely to occur. However, this does not imply that these verbs only appear within these contexts.

For obvious reasons, the number of words per page has been limited. In addition, attempts have been made to place the numbers on the art consecutively, either from left to right, or, on many contextualized pages, in a circular, clockwise order.

A complete index with pronunciation guide has been included in the Appendix. [For practice exercises using *The Canadian Oxford Picture Dictionary*, please refer to *The Canadian Oxford Picture Dictionary Workbooks*. These workbooks cover material for both beginning and intermediate level speakers.]

加拿大牛津英漢圖畫字典 (*The Canadian Oxford Picture Dictionary*) 根據特定的內容說明超過 2,400 個英文字。這本字典是學習英語的學生一種十分獨特的語言學習工具。它使學生能夠對加拿大的生活方式有一個認識，也是有用生字的總匯。

這本字典是根據不同的主題編撰而成，字典是以最能夠幫助學生在英語國家“生存”的有用題目開始。然後，轉為較一般性質的題目，包括那些可能會用在加拿大學校的社會科學等班的題目。儘管如此，各頁可根據學生特別的需要而不順序使用。本字典并不需要按照頁數的先後次序教授。

本字典揀選需要基本英語技巧的學生來說最有用的生字。為了達到簡單明瞭的效果，任何物件均採用最常用的名稱。

加拿大牛津英漢圖畫字典 (*The Canadian Oxford Picture Dictionary*) 儘可能在特定的內容下說明生字，使學習語言的工作變得容易一些。雖然動詞均獨立地列出，但是都是列在最可能出現的題目範圍內。儘管如此，這並非表示該些動詞只會在該等內容才會出現。

基於明顯的原因，每頁的生字數量皆有限制。此外，每頁亦嘗試在圖畫上配上適當的號碼，從左至右，或在許多特定內容的頁數上，以圓形和順時針的次序列出。

附錄已經包括發音指導的完整索引。[使用加拿大牛津英漢圖畫字典 (*The Canadian Oxford Picture Dictionary*) 來做練習，請參考加拿大牛津英漢圖畫字典作業 (*The Canadian Oxford Picture Dictionary Workbooks*)。這本作業包括初學和中級程度學生所需要的材料。]

People and Relationships 人物及其關係	2
The Family 家庭	3
The Human Body 人體	4-5
✓ Vegetables 蔬菜	6-7
✓ Fruits 水果、生果	8-9
Meat, Poultry, and Seafood 肉類、家禽及海產	10-11
Containers and Quantities 容器、器皿及份量	12-13
✓ The Supermarket 超級市場	14-15
Family Restaurant and Cocktail Lounge 家庭式餐廳及雞尾酒酒廊	16
Restaurant Verbs 餐廳/酒樓用詞 (動詞)	17
Common Prepared Foods 家常食物	18
Outdoor Clothes 戶外服裝	19
Everyday Clothes 日常服裝	20-21
Underwear and Sleepwear 內衣及睡衣	22
Jewellery and Cosmetics 珠寶及化妝品	23
Describing Clothes 形容服裝	24
Caring for Clothes (Doing Laundry) 處理衣物 (洗衫)	25
Describing the Weather 形容天氣	26
Seasonal Verbs 季節用詞 (動詞)	27
Places to Live 居住地方	28
Houses 房屋	29
The Living Room 客廳	30
The Dining Room 飯廳	31
The Kitchen 廚房	32
Kitchen Verbs 廚房用詞 (動詞)	33
The Bedroom 睡房	34
The Baby's Room 嬰兒房	35
The Bathroom 浴室	36
Utility Room 儲藏家庭用具及供應品的房間	37
A Workshop 工作間	38-39
Home Repair and Housing Problems 房屋修理和住屋問題	40-41
Housework and Repair Verbs 家務及修理用詞 (動詞)	42
Medical and Dental Care 醫療及牙齒保健	43
Ailments and Injuries 疾病及損傷	44
Treatments and Remedies 治療及補救	45
Rescue and Emergency Medical Care 拯救及緊急醫療護理	46
Crime and Punishment 犯罪及懲罰	47
✓ The City 城市	48-49
Canada Post 加拿大郵政	50
✓ The Public Library 公立圖書館	51
Modes of Transportation 交通方式、運輸方式	52
Highway Travel 高速公路行車	53
✓ Cars 轎車、汽車	54-55
Public Transportation 公共交通運輸	56-57

Air Travel 航空旅行	58
A Classroom 班房	59
✓ School Verbs 學校用詞 (動詞)	60
Math 數學	61
Plants and Trees 植物及樹木	62-63
Simple Animals 低等動物	64
Insects 昆蟲	65
Birds 雀鳥、鳥類	66
Fish and Reptiles 魚類及爬蟲類	67
Mammals I 哺乳類一	68-69
Mammals II 哺乳類二	70-71
Map of the World 世界地圖	72-73
Map of Canada 加拿大地圖	74
Emblems of Canada and Canadian Currency 加拿大標記和加幣	75
Provincial Symbols 省份標記	76-77
Government in Canada 加拿大政府	78
The Universe 宇宙	79
Energy 能源	80
Farming and Ranching 農作及畜牧	81
Construction 建築	82
An Office 寫字樓、辦公室	83
Occupations I 職業一	84
Occupations II 職業二	85
Occupations III 職業三	86
Neighborhood Parks 鄰里公園	87
Outdoor Activities 戶外活動	88-89
At the Beach 在海灘	90-91
Team Sports 球隊運動	92
Baseball and Hockey 棒球及冰上曲棍球	93
Individual Sports 個人運動	94
Fields and Courses 場地	95
Sports Verbs 運動用詞 (動詞)	96-97
Musical Instruments 樂器	98
Music, Dance, and Theatre 音樂、舞蹈及劇院	99
Electronics and Photography 電子及攝影器材	100
Handicrafts 手工藝	101
Prepositions of Description 形容用詞 (介詞)	102
Prepositions of Motion 動作動詞 (介詞)	103
Appendix 附錄	104
Index 索引	105

## 2 People and Relationships

### 人物及其關係



女人 1. woman  
男人 2. man  
丈夫 3. husband  
妻子 4. wife

嬰兒 5. baby  
父母 6. parents  
子女 7. children  
男孩 8. boy

女孩 9. girl  
祖父母、外祖父母 10. grandparents  
孫女、外孫女 11. granddaughter  
孫、外孫 12. grandson

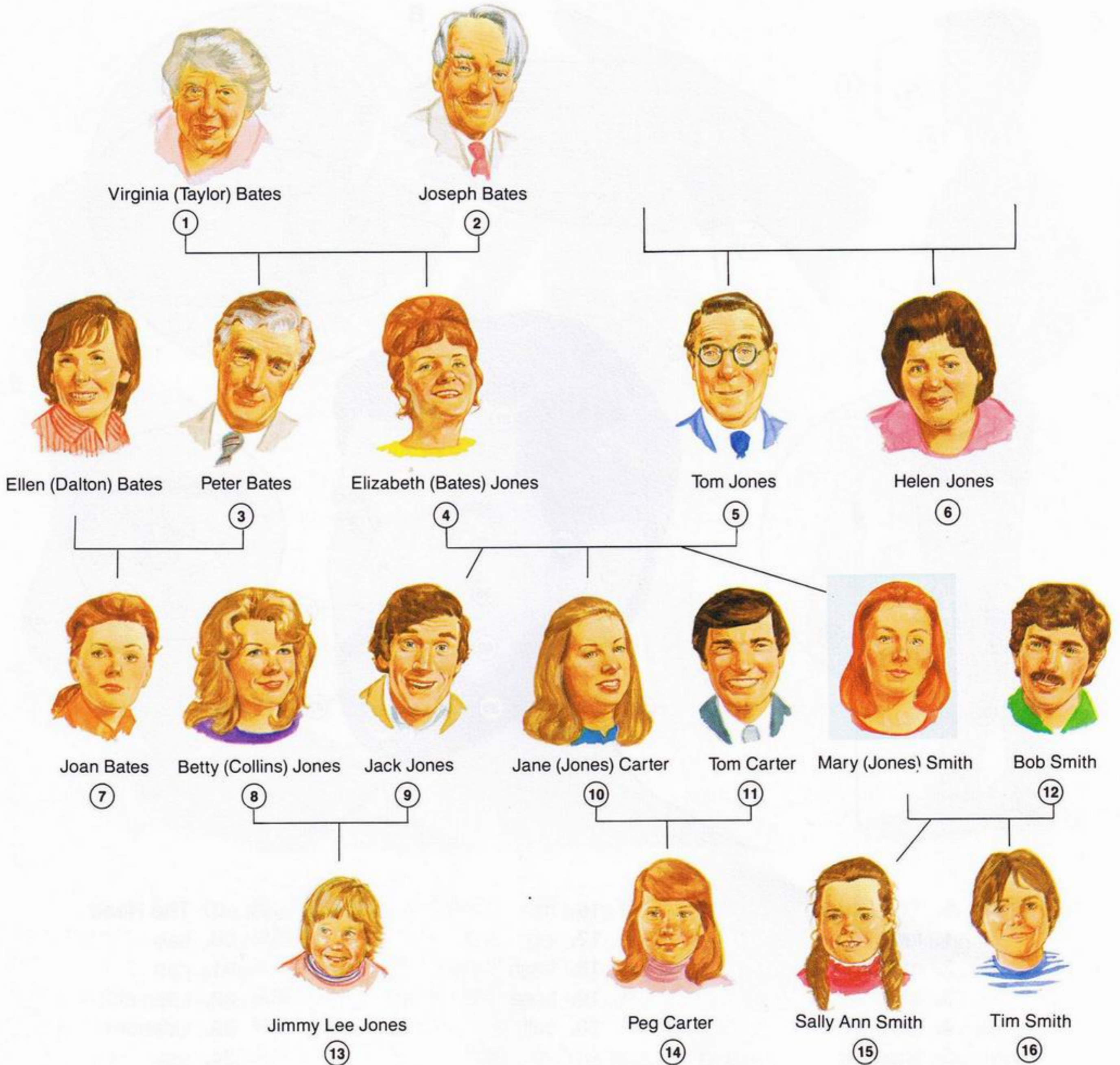

瑪莉史密夫  
家庭  
祖母、外祖母  
祖父、外祖父  
伯父、叔叔、  
舅父  
母親

**Mary Smith's Family**

- 1. grandmother
- 2. grandfather
- 3. uncle
- 4. mother

父親  
姑媽、姑姑、  
姨媽、阿姨  
堂姐、妹、兄、弟、  
表姐、妹、兄、弟  
阿嫂、弟媳  
哥哥、弟弟

- 5. father
- 6. aunt
- 7. cousin
- 8. sister-in-law
- 9. brother

姐姐、妹妹  
姐夫、妹夫  
丈夫  
侄、外甥  
侄女、外甥女  
女兒  
兒子

- 10. sister
- 11. brother-in-law
- 12. husband
- 13. nephew
- 14. niece
- 15. daughter
- 16. son

# 4 The Human Body

人體

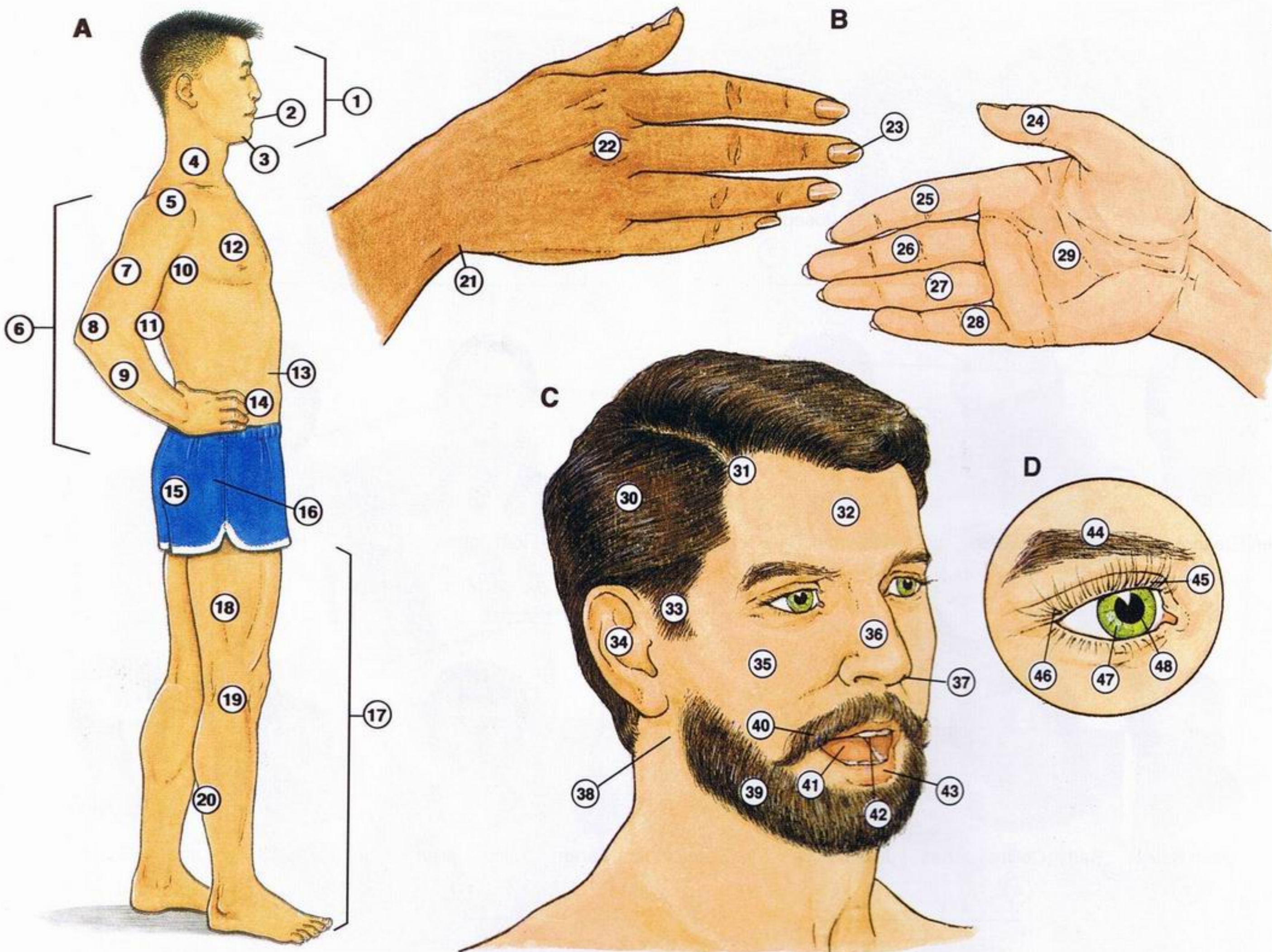

- 身體 A. The Body**
- 面 1. face
  - 口、嘴 2. mouth
  - 下巴 3. chin
  - 頸 4. neck
  - 肩膀 5. shoulder
  - 手臂 6. arm
  - 上臂 7. upper arm
  - 手肘 8. elbow
  - 前臂 9. forearm
  - 腋下、腋窩 10. armpit
  - 背 11. back
  - 胸 12. chest
  - 腰 13. waist
  - 腹 14. abdomen
  - 屁股 15. buttocks

- 手 B. The Hand**
- 臀部 16. hip
  - 整隻腳 17. leg
  - 大腿 18. thigh
  - 膝 19. knee
  - 小腿 20. calf
  - 手腕 21. wrist
  - 指關節 22. knuckle
  - 指甲 23. fingernail
  - 拇指 24. thumb
  - 食指 25. (index) finger
  - 中指 26. middle finger
  - 無名指 27. ring finger
  - 手指尾 28. little finger
  - 手掌 29. palm

- 頭 C. The Head**
- 頭髮 30. hair
  - 分界線 31. part
  - 額頭 32. forehead
  - 髮腳 33. sideburn
  - 耳朵 34. ear
  - 面珠 35. cheek
  - 鼻子 36. nose
  - 鼻孔 37. nostril
  - 下顎 38. jaw
  - 鬍鬚 39. beard
  - 二撇雞 40. mustache
  - 舌頭 41. tongue
  - 牙齒 42. tooth
  - 口唇、嘴唇 43. lip

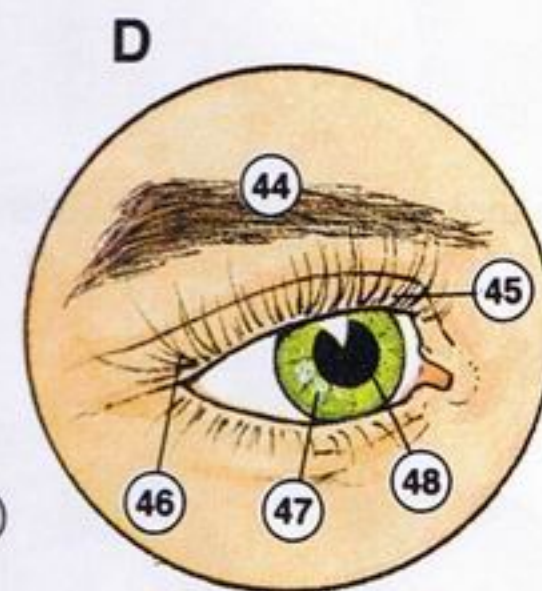



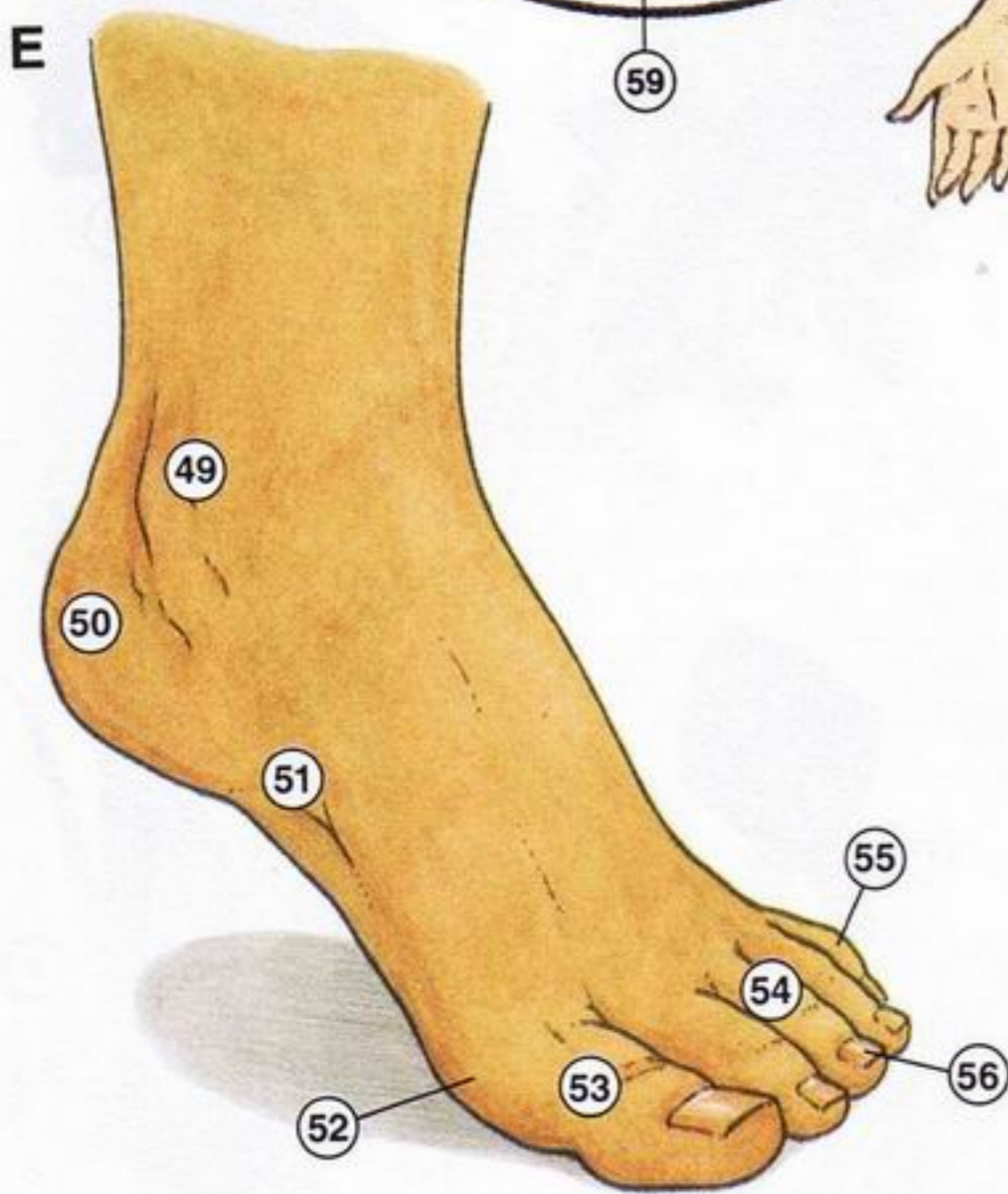
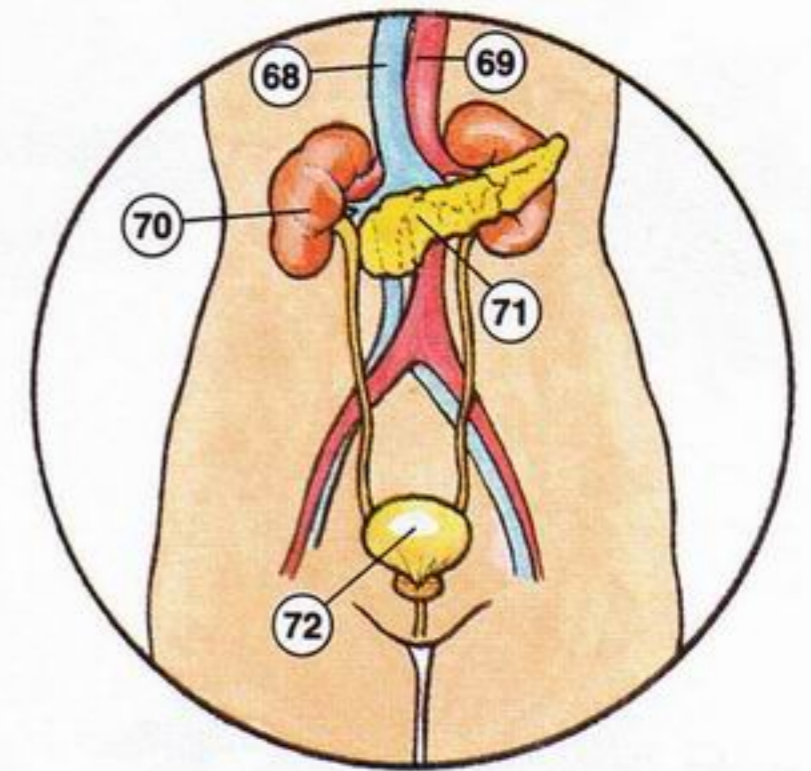
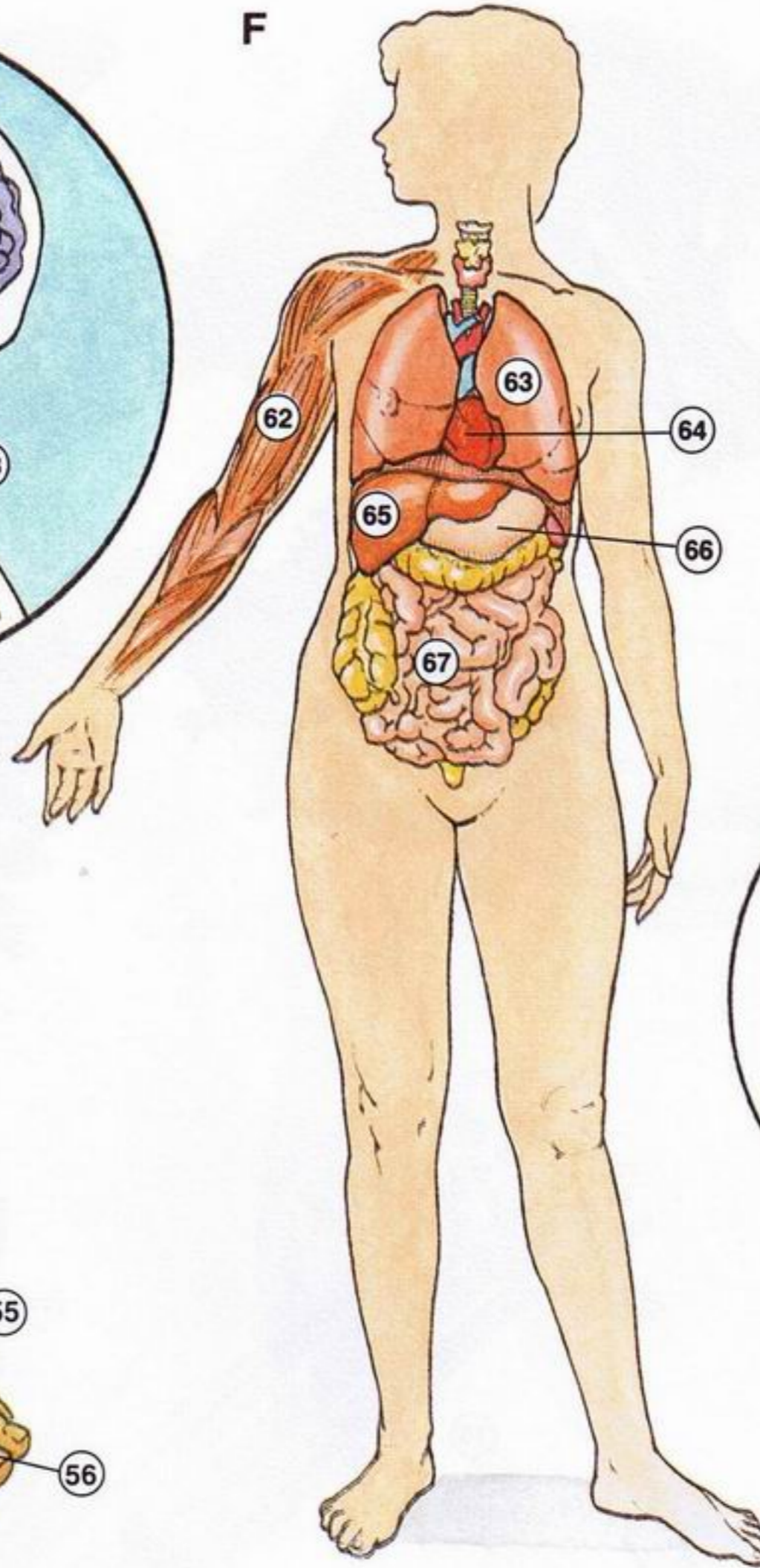
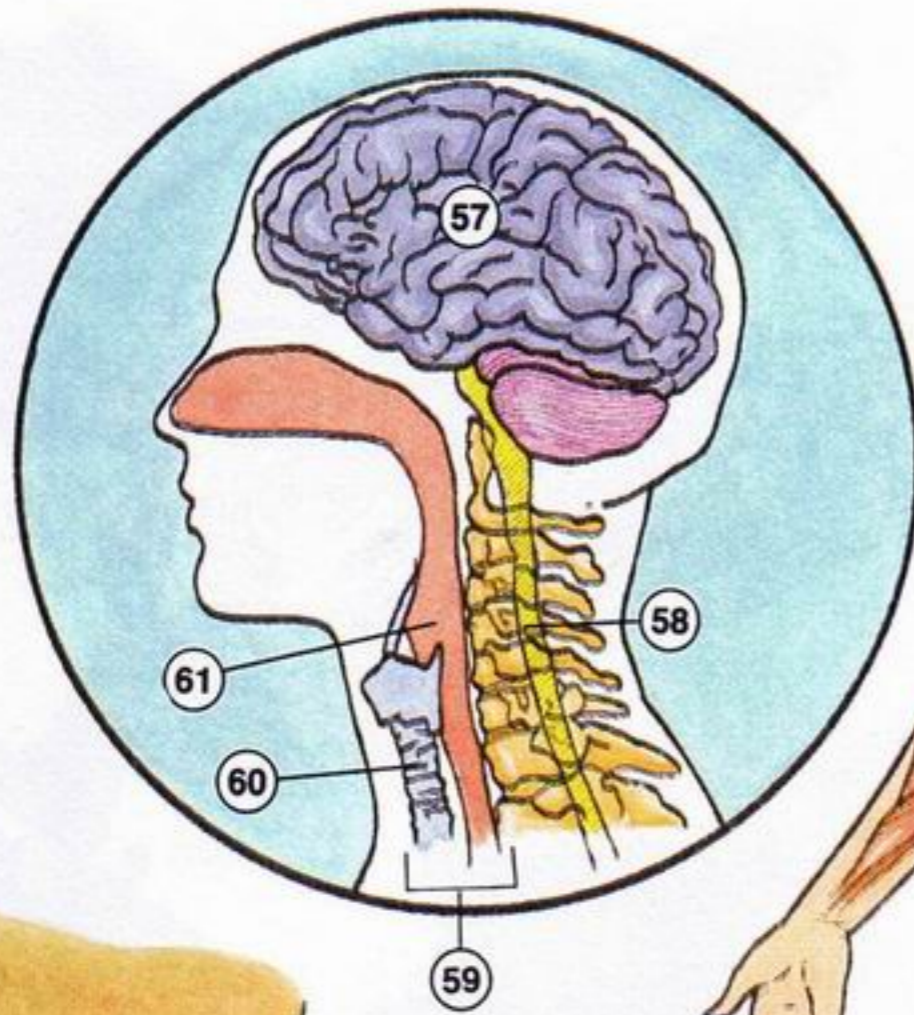

- D. The Eye**  
 眼睛 44. eyebrow  
 眉毛、眼眉毛 45. eyelid  
 眼皮 46. eyelashes  
 眼睫毛 47. iris  
 虹膜 48. pupil  
 瞳孔

- E. The Foot**  
 腳 49. ankle  
 腳眼 50. heel  
 腳踵 51. instep  
 腳背凹入的地方 52. ball  
 腳墊

- 腳趾公 53. big toe  
 腳趾 54. toe  
 腳趾尾 55. little toe  
 腳趾甲、腳甲 56. toenail

- F. The Internal Organs**  
 內臟 57. brain  
 腦 58. spinal cord  
 脊椎 59. throat  
 喉嚨 60. windpipe  
 氣管 61. esophagus  
 食道

- 肌肉 62. muscle  
 肺 63. lung  
 心臟 64. heart  
 肝 65. liver  
 胃 66. stomach  
 腸 67. intestines  
 靜脈 68. vein  
 動脈 69. artery  
 腎 70. kidney  
 胰臟 71. pancreas  
 膀胱 72. bladder

蔬菜



(束) 椰菜花 1. (head of) cauliflower  
 西蘭花 2. broccoli  
 大白菜 3. cabbage  
 菜頭 4. brussels sprouts  
 西洋菜 5. watercress  
 西生菜、生菜 6. lettuce  
 生菜 7. escarole

波菜 8. spinach  
 草藥、 9. herb(s)  
 生草藥  
 芹菜、西芹 10. celery  
 朝鮮蓊 11. artichoke  
 (條) 粟米 12. (ear of) corn  
 粟米心 a. cob

豬腰豆 13. kidney bean(s)  
 黑豆 14. black bean(s)  
 四季豆 15. string bean(s)  
 蠶豆 16. lima bean(s)  
 青豆 17. pea(s)  
 莢 a. pod  
 蘆筍 18. asparagus



蕃茄 19. tomato(es)  
 青瓜 20. cucumber(s)  
 茄子 21. eggplant  
 辣椒 22. pepper(s)  
 薯仔 23. potato(es)  
 蕃薯 24. yam

大蒜、蒜頭 25. garlic  
 鱗莖、珠芽 a. clove  
 南瓜 26. pumpkin  
 祖齊瓜 27. zucchini  
 橡形南瓜 28. acorn squash  
 辣根 29. radish(es)

蘑菇 30. mushroom(s)  
 洋蔥 31. onion(s)  
 蘿蔔 32. carrot(s)  
 甜菜頭 33. beet(s)  
 白蘿蔔 34. turnip



- (一串) 1. (a bunch of) 葡提子 grapes  
 蘋果 2. apple  
 蘋果梗 a. stem  
 蘋果心 b. core  
 椰子 3. coconut  
 菠蘿 4. pineapple  
 芒果 5. mango  
 木瓜 6. papaya

- 柑橘類水果  
 西柚 7. grapefruit  
 橙 8. orange  
 片 a. section  
 皮 b. rind  
 核 c. seed  
 檸檬 9. lemon  
 青檸、青檸檬 10. lime

- 莓類  
 鵝莓 11. gooseberries  
 黑莓 12. blackberries  
 酸果莓 13. cranberries  
 藍莓 14. blueberries  
 士多啤梨 15. strawberry  
 勒士草莓 16. raspberries  
 葡果梨 17. nectarine  
 梨 18. pear

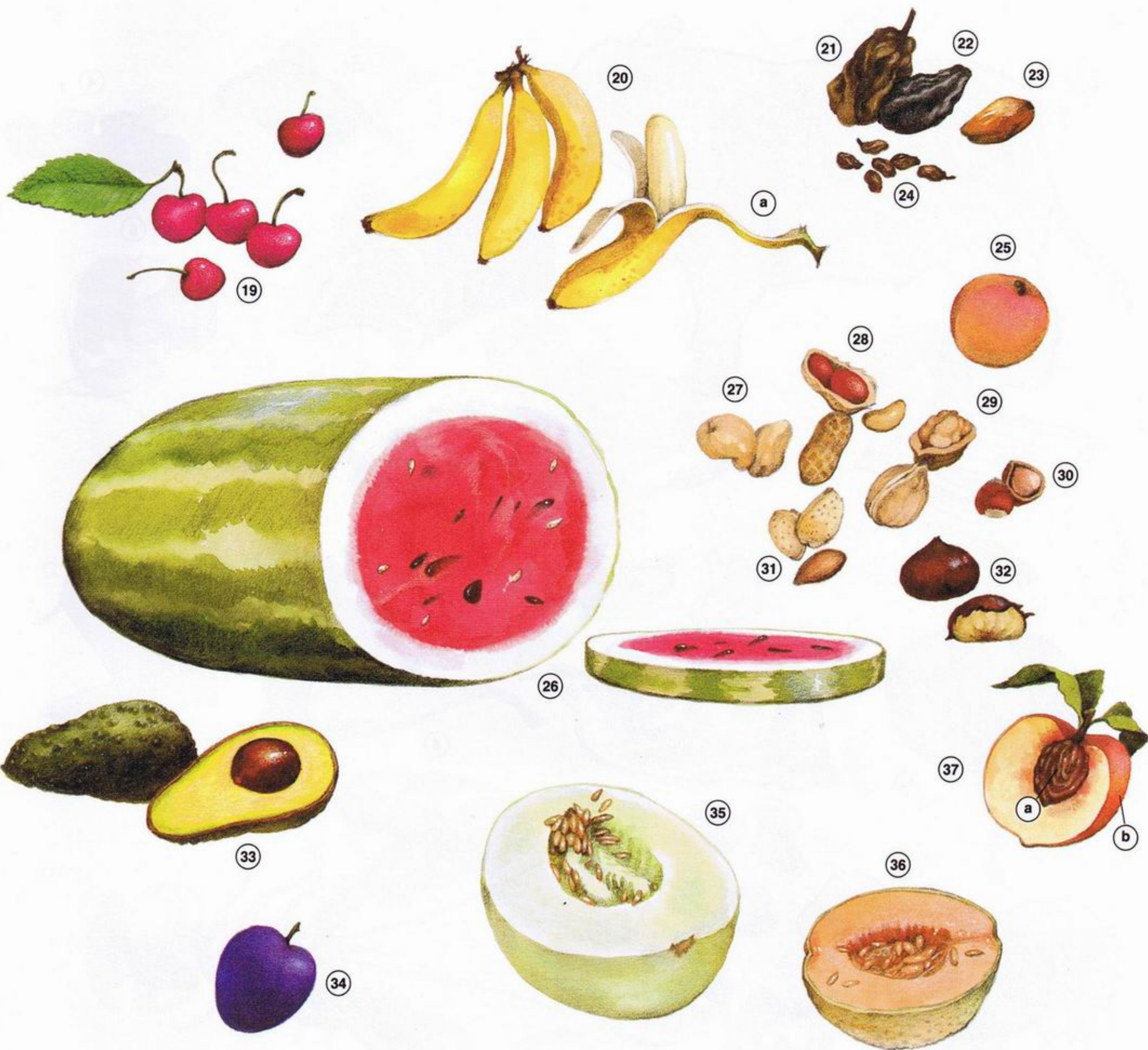

櫻桃、車厘子 19. cherries  
 (一梳) 香蕉 20. (a bunch of) bananas  
 香蕉皮 a. peel

**乾果類 Dried Fruits**

無花果 21. fig  
 西梅 22. prune  
 棗 23. date  
 提子乾、 24. raisin(s)  
 葡提子乾

杏脯 25. apricot  
 西瓜 26. watermelon

**果仁 Nuts**

腰果 27. cashew(s)  
 花生 28. peanut(s)  
 核桃 29. walnut(s)  
 榛子仁 30. hazelnut(s)  
 杏仁 31. almond(s)  
 栗子 32. chestnut(s)

牛油果 33. avocado  
 布甸 34. plum  
 哈密瓜 35. honeydew melon  
 皺皮瓜 36. cantaloupe  
 桃 37. peach  
 桃核 a. pit  
 桃皮 b. skin

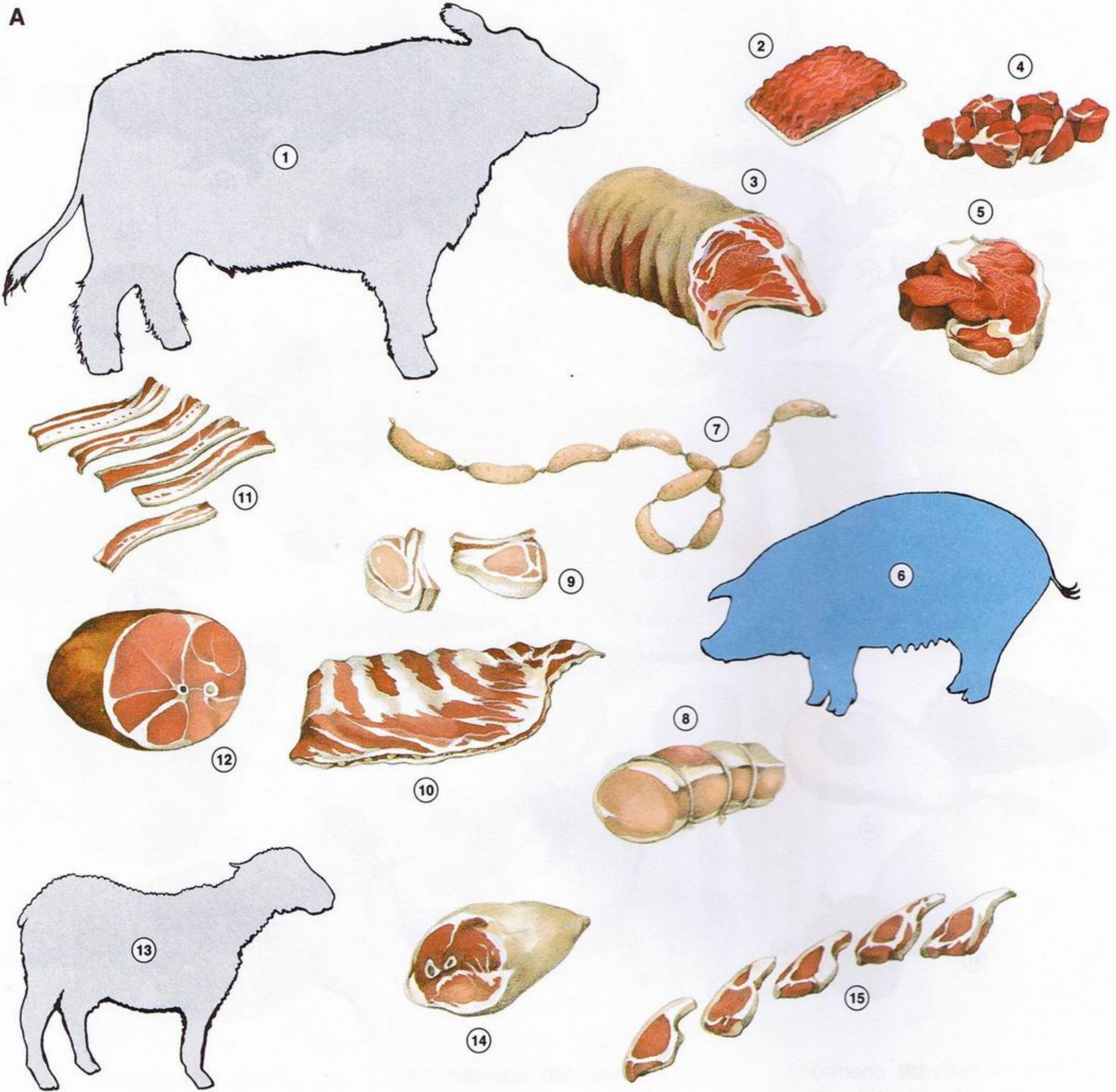

- 肉 **A. Meat**  
 牛肉 1. beef  
 絞碎牛肉 2. ground beef  
 燒肉 3. roast  
 燉肉 4. stewing meat  
 肉排 5. steak

- 豬肉 6. pork  
 香腸 7. sausage  
 燒扒 8. roast  
 扒 9. chops  
 排骨 10. spare ribs

- 煙肉 11. bacon  
 火腿 12. ham  
 羊 13. lamb  
 腿 14. leg  
 扒 15. chops

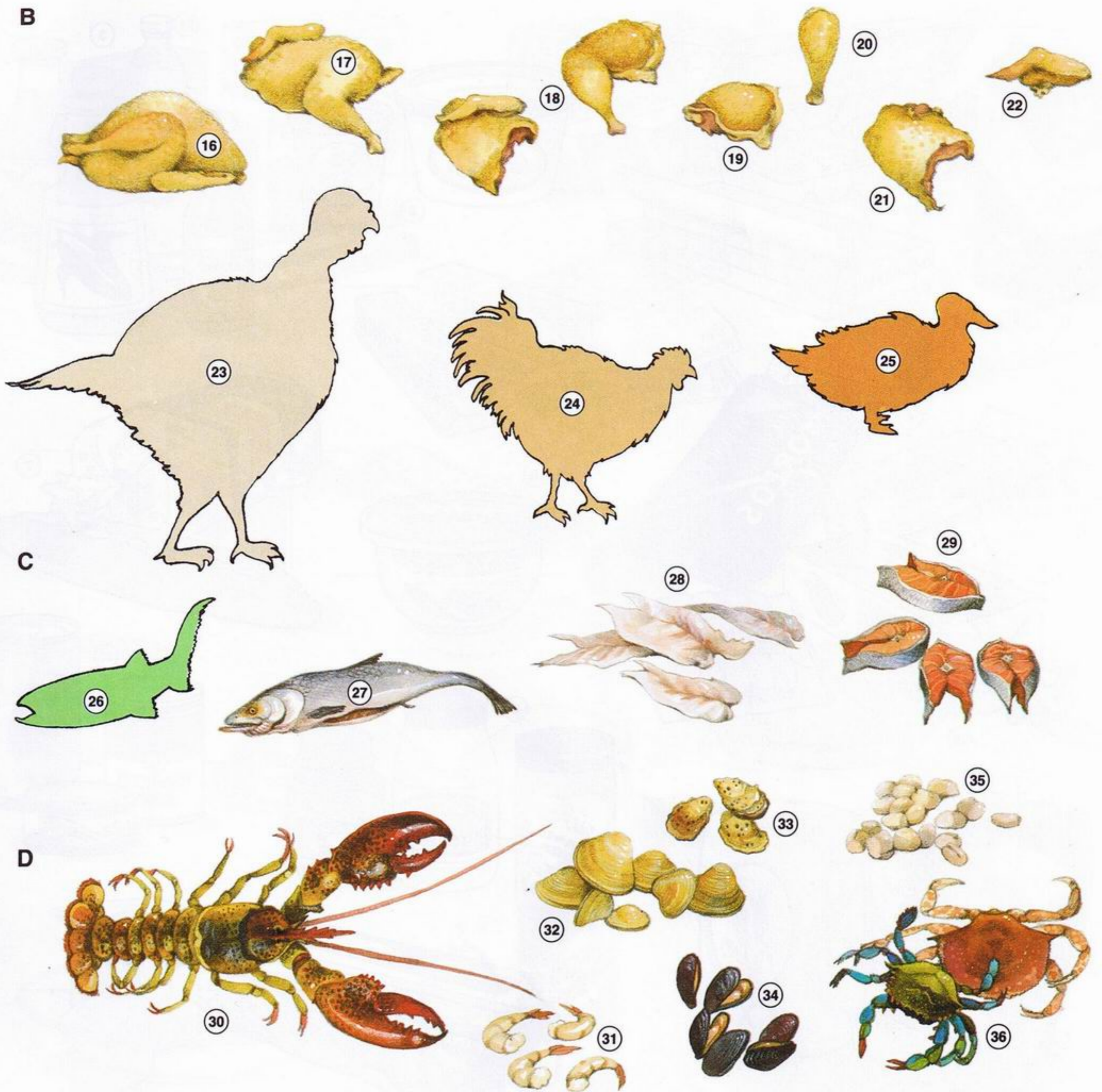

- 家禽 B. Poultry**
- 全隻雞 16. whole (chicken)
  - 半隻雞 17. split
  - 四分之一隻雞/  
雞脾 18. quarter
  - 大腿 19. thigh
  - 雞脾 20. leg
  - 雞胸 21. breast
  - 雞翼 22. wing

- 海產食品 C. Seafood**
- 火雞 23. turkey
  - 雞 24. chicken
  - 鴨 25. duck
  - 魚 26. fish
  - 全條魚 27. whole
  - 魚柳 28. filet
  - 魚排 29. steak

- 貝殼類魚類 D. Shellfish**
- 龍蝦 30. lobster
  - 蝦 31. shrimp
  - 蛤 32. clam(s)
  - 生蠔、蠔 33. oyster(s)
  - 青口 34. mussel(s)
  - 帶子 35. scallop(s)
  - 蟹 36. crab(s)



盒 1. carton  
 容器、器皿 2. container  
 樽 3. bottle  
 包裝 4. package

條、片、塊 5. stick  
 盒、盆 6. tub  
 條 7. loaf  
 袋 8. bag

樽 9. jar  
 罐 10. can  
 卷 11. roll





盒 12. box  
 半打裝 13. six-pack  
 唧筒 14. pump  
 支 15. tube  
 包 16. pack

本 17. book  
 塊、條 18. bar  
 杯 19. cup  
 玻璃杯 20. glass  
 片、塊 21. slice

塊、件 22. piece  
 碗 23. bowl  
 噴霧式罐裝 24. spray can/aerosol can  
 可以回收、  
 可以循環再造 25. recyclable

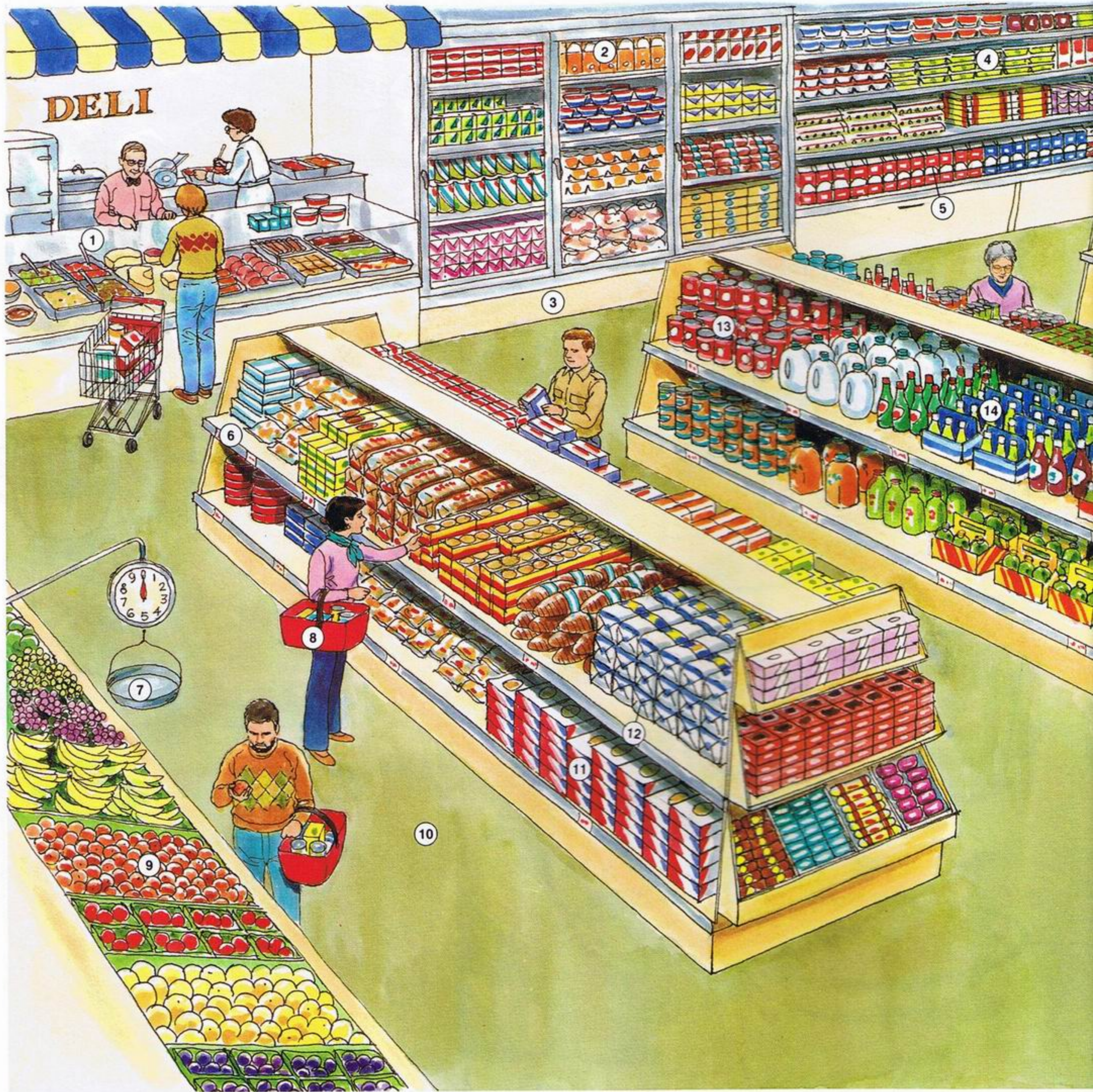

- 熟食部 1. deli counter
- 急凍食物 2. frozen foods
- 冷藏櫃、 3. freezer
- 急凍櫃
- 乳類產品 4. dairy products
- 牛奶 5. milk

- 貨架 6. shelf
- 秤 7. scale
- 購物籃 8. shopping basket
- 大量生產的農 9. produce
- 作物
- 走廊、通道 10. aisle

- 焗的食物 11. baked goods
- 麵包 12. bread
- 罐裝食物、 13. canned goods
- 罐頭食物
- 飲料 14. beverages

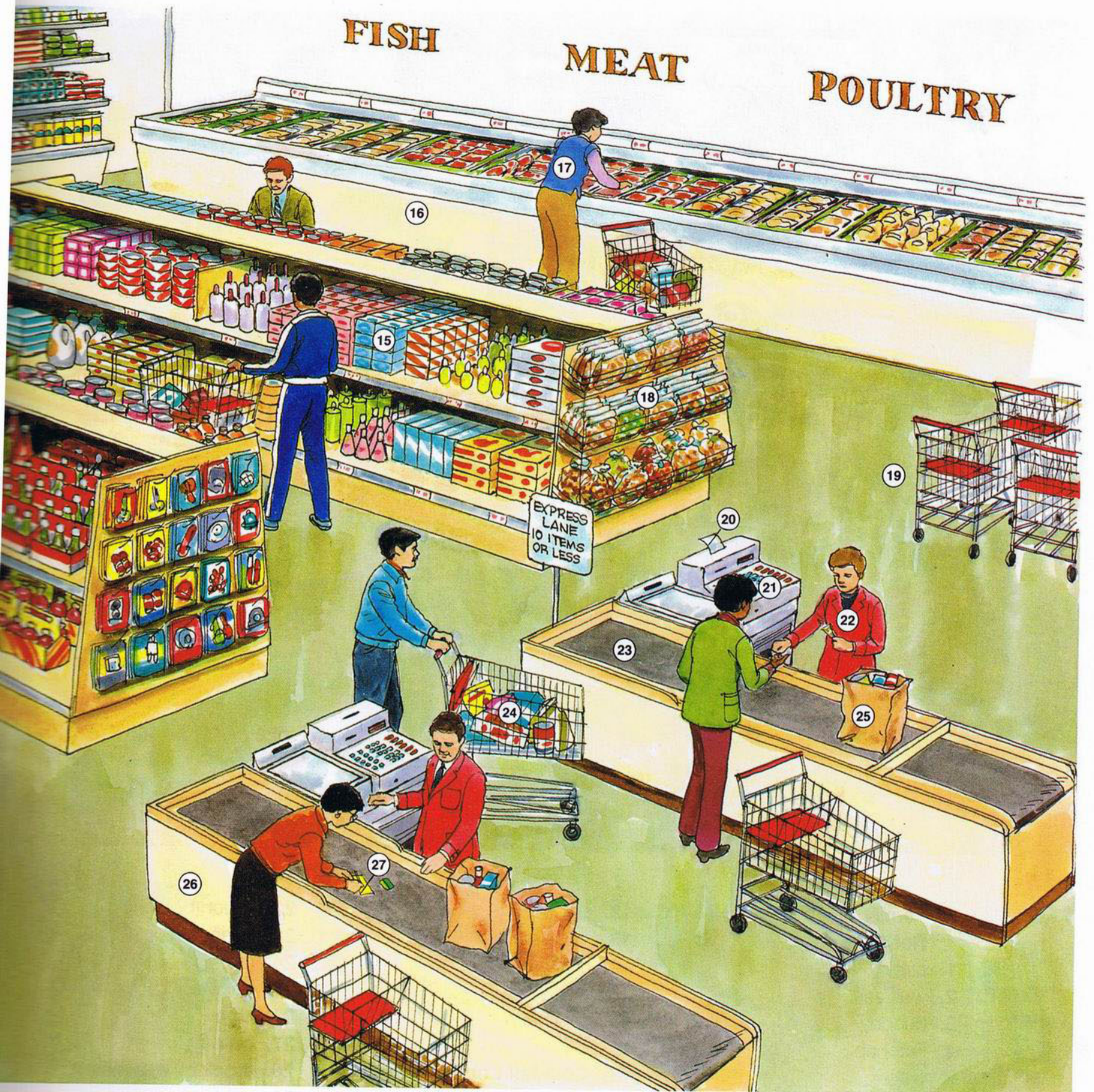

家庭用品 15. household items  
 貯藏櫃 16. bin  
 顧客 17. customer  
 零食、小食 18. snacks  
 手推車、車仔 19. shopping cart

收據 20. receipt  
 收銀機 21. cash register  
 收銀、收銀員 22. cashier  
 輸送帶 23. conveyor belt

雜貨 24. groceries  
 袋 25. bag  
 收銀處 26. checkout counter  
 支票 27. cheque

家庭式餐廳及雞尾酒酒廊

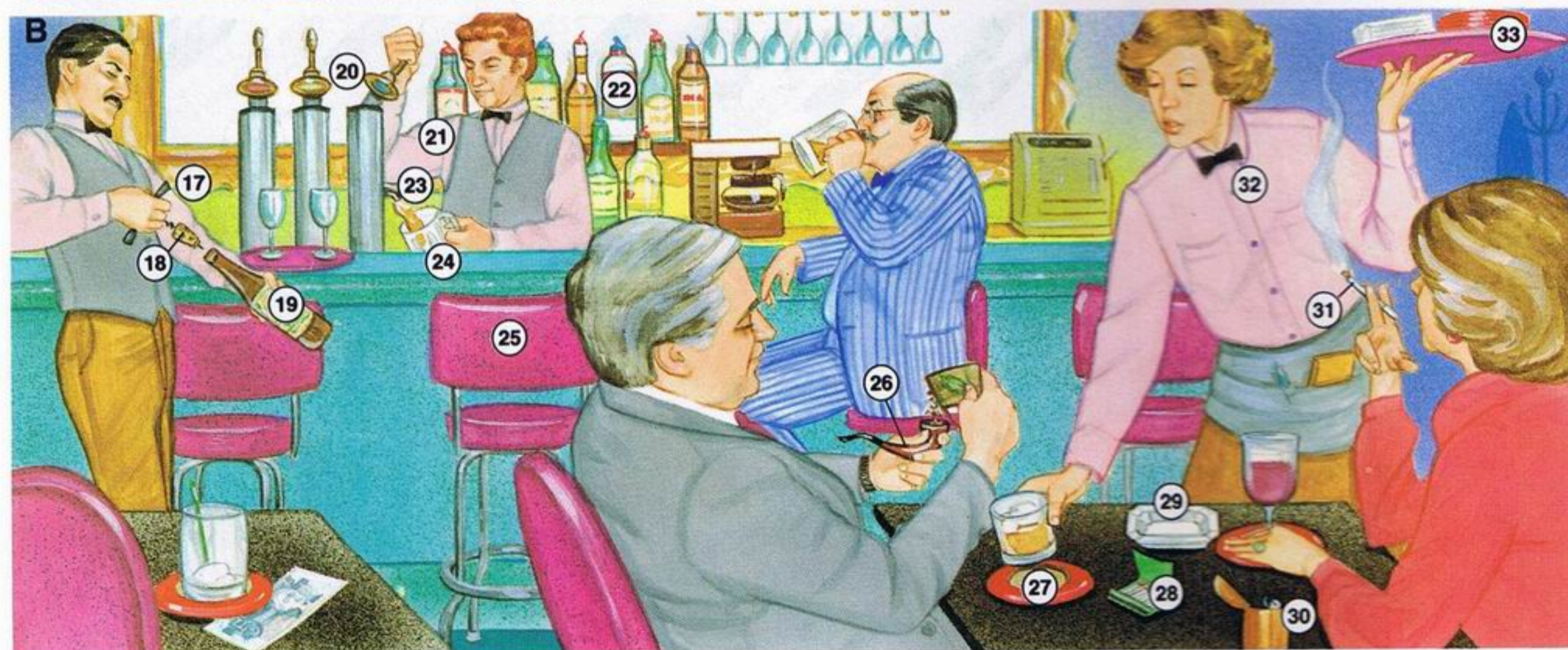

家庭式餐館

**A. Family Restaurant**

- 廚師 1. cook
- 女伙記 2. waitress
- 收碗碟男工 3. busboy
- 蕃茄醬、茄汁 4. ketchup
- 男伙記 5. waiter
- 圍裙 6. apron
- 菜牌 7. menu
- 高椅 8. high chair
- 雅座、卡位 9. booth
- 飲管 10. straw
- 汽水 11. soft drink/pop

- 自動點唱機 12. jukebox
- 糖(包) 13. sugar(packet)
- 單 14. check
- 茶 15. tea
- 三文治 16. sandwich

雞尾酒酒廊 **B. Cocktail Lounge**

- 樽塞鑽 17. corkscrew
- 活塞 18. cork
- 酒 19. wine
- 栓、塞 20. tap
- 酒保、調酒師 21. bartender

- 酒(樽) 22. liquor (bottle)
- 啤酒 23. beer
- 酒吧 24. bar
- 酒吧高椅 25. bar stool
- 煙斗 26. pipe
- 杯墊 27. coaster
- (薄盒) 火柴 28. (book of) matches
- 煙灰缸 29. ashtray
- 打火機 30. lighter
- 香煙 31. cigarette
- 雞尾酒女伙記 32. cocktail waitress
- 托盤 33. tray

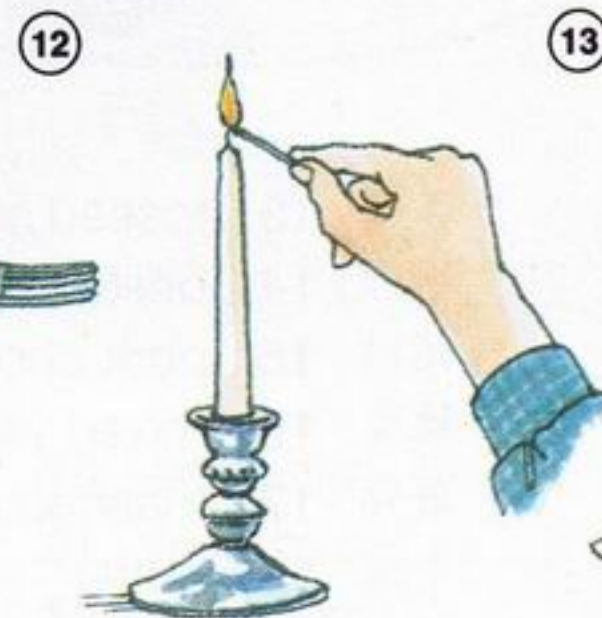
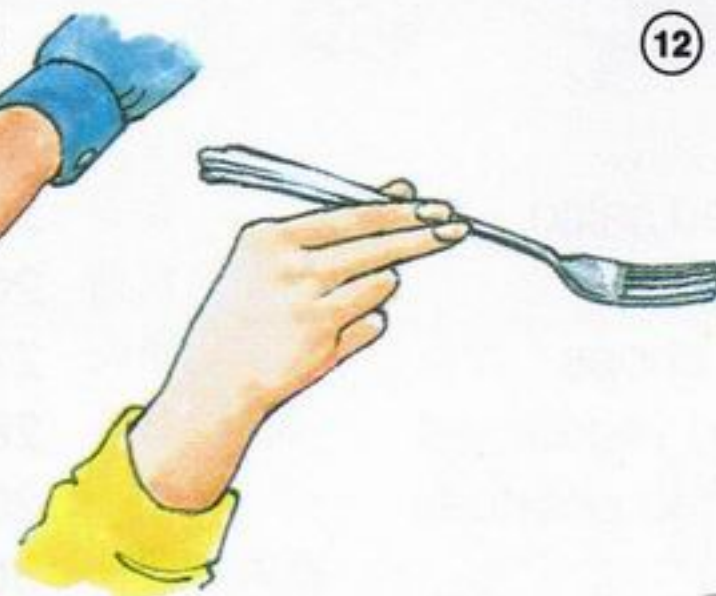
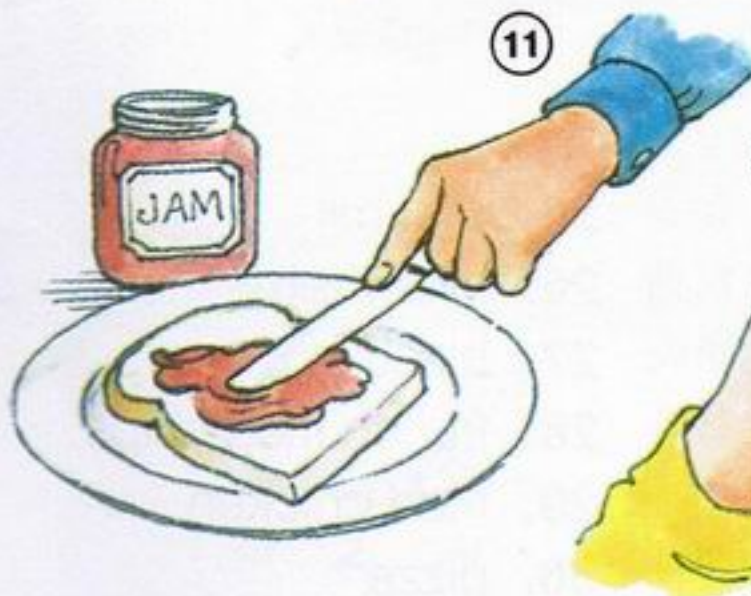
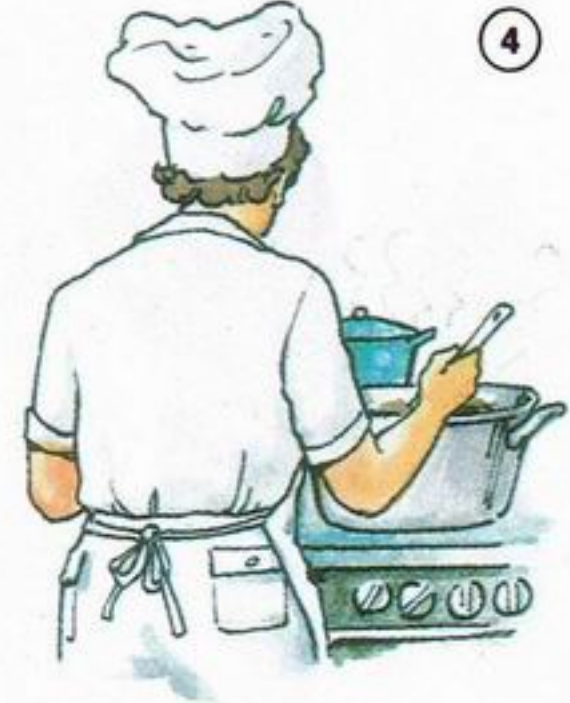

- 食、吃 1. eat
- 喝、飲 2. drink
- 服侍 3. serve
- 煮食 4. cook
- 點菜 5. order

- 收拾乾淨 6. clear
- 付錢 7. pay
- 擺枱 8. set (the table)
- 給 9. give
- 拿 10. take

- 塗、搽 11. spread
- 拿 12. hold
- 點 13. light
- 燙 14. burn

家常食物



- |       |                    |       |                      |        |                          |
|-------|--------------------|-------|----------------------|--------|--------------------------|
| 芥菜    | 1. mustard         | 沙律    | 13. tossed salad     | 春卷     | 25. egg roll             |
| 熱狗    | 2. hot dog         | 燉牛肉   | 14. beef stew        | 士多啤梨鬆餅 | 26. strawberry shortcake |
| 焗豆    | 3. baked beans     | 豬扒    | 15. pork chops       | 餅乾     | 27. biscuit              |
| 薯片    | 4. potato chips    | 雜菜    | 16. mixed vegetables | 薯條/薯片  | 28. french fries/chips   |
| 班戟    | 5. pancakes        | 薯茸    | 17. mashed potatoes  | 炸雞     | 29. fried chicken        |
| 糖漿    | 6. syrup           | 牛油    | 18. butter           | 義大利薄餅  | 30. pizza                |
| 麵包    | 7. bun             | 麵包    | 19. roll             | 啫喱     | 31. jelly                |
| 酸瓜    | 8. pickle          | 焗薯仔   | 20. baked potato     | 荷包蛋    | 32. (sunny-side up) eggs |
| 漢堡包   | 9. hamburger       | 牛扒    | 21. steak            | 煙肉     | 33. bacon                |
| 意大利粉、 | 10. spaghetti      | 曲奇    | 22. cookie           | 多士     | 34. toast                |
| 意粉    |                    | 新地    | 23. sundae           | 咖啡     | 35. coffee               |
| 肉丸    | 11. meatballs      | 墨西哥脆卷 | 24. taco             | 雪糕筒    | 36. ice cream cone       |
| 沙律醬   | 12. salad dressing |       |                      |        |                          |

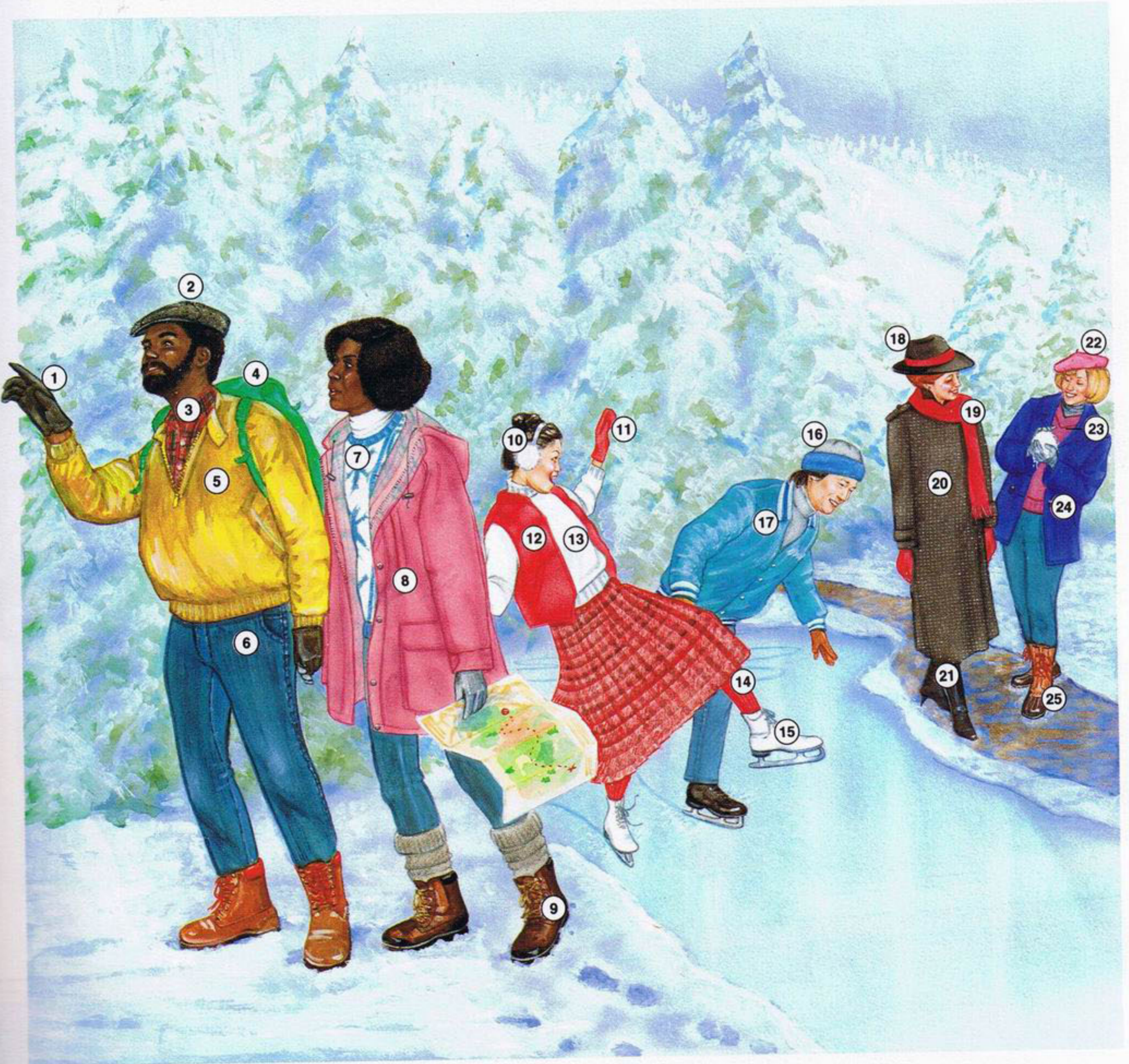

- |          |                       |          |                          |           |                      |
|----------|-----------------------|----------|--------------------------|-----------|----------------------|
| 手套       | 1. gloves             | 禦寒耳罩     | 10. earmuffs             | 帽         | 18. hat              |
| 帽        | 2. cap                | 手套       | 11. mittens              | 頸巾        | 19. scarf            |
| 法蘭絨恤衫    | 3. flannel shirt      | 羽絨背心     | 12. down vest            | 長大衣、長襖    | 20. overcoat         |
| 背囊       | 4. backpack           | (樽領) 毛衣、 | 13. (turtleneck) sweater | 靴         | 21. boots            |
| 風衣       | 5. windbreaker        | (樽領) 冷衫  | 14. tights               | 扁帽        | 22. beret            |
| 牛仔褲      | 6. (blue) jeans       | 緊身褲      | 15. ice skates           | (V-領) 毛衣、 | 23. (V-neck) sweater |
| (圓領) 毛衣、 | 7. (crewneck) sweater | 滑冰鞋      | 16. ski cap/toque        | (V-領) 冷衫  | 24. coat             |
| (圓領) 冷衫  | 8. parka              | 滑雪帽      | 17. jacket               | 外套、襖      | 25. rain boots       |
| 連帽羽絨     | 9. hiking boots       |          |                          | 雨靴        |                      |

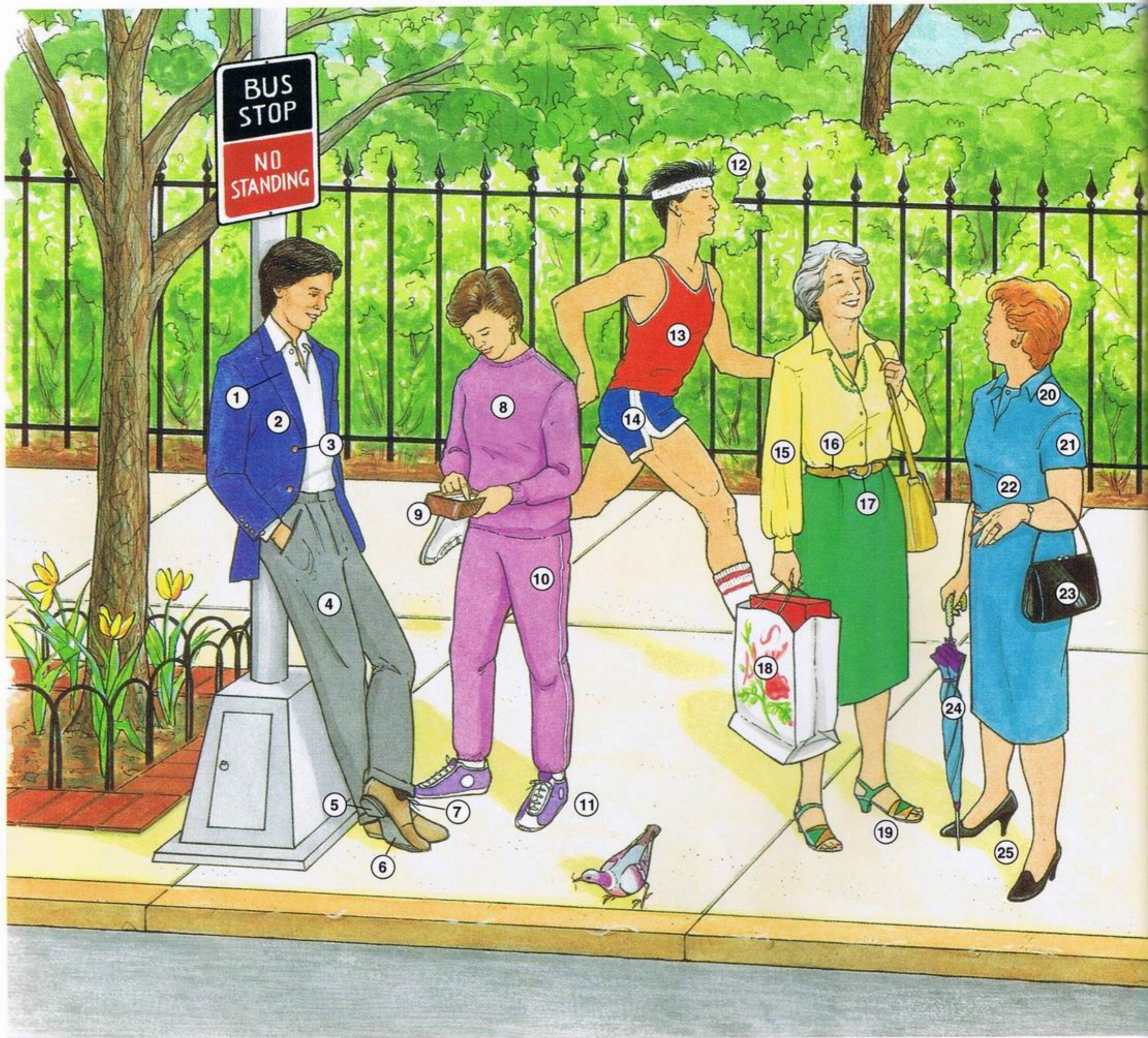

- |          |               |         |                      |       |                  |
|----------|---------------|---------|----------------------|-------|------------------|
| 反領       | 1. lapel      | 運動長褲、汗褲 | 10. sweatpants       | 購物袋   | 18. shopping bag |
| 西裝褸      | 2. blazer     | 波鞋、     | 11. sneakers/running | 涼鞋    | 19. sandal       |
| 鈕        | 3. button     | 運動鞋/跑鞋  | shoes                | 領     | 20. collar       |
| 鬆身褲、便褲   | 4. slacks     | 頭箍      | 12. sweatband        | 短袖    | 21. short sleeve |
| 鞋        | 5. heel       | 背心      | 13. tank top         | 裙     | 22. dress        |
| 鞋底       | 6. sole       | 短褲      | 14. shorts           | 銀包/手袋 | 23. purse        |
| 鞋帶       | 7. shoelace   | 長袖      | 15. long sleeve      | 雨傘    | 24. umbrella     |
| 運動長袖衫、汗衫 | 8. sweatshirt | 皮帶      | 16. belt             | 高跟鞋   | 25. (high) heels |
| 銀包       | 9. wallet     | 皮帶扣     | 17. buckle           |       |                  |



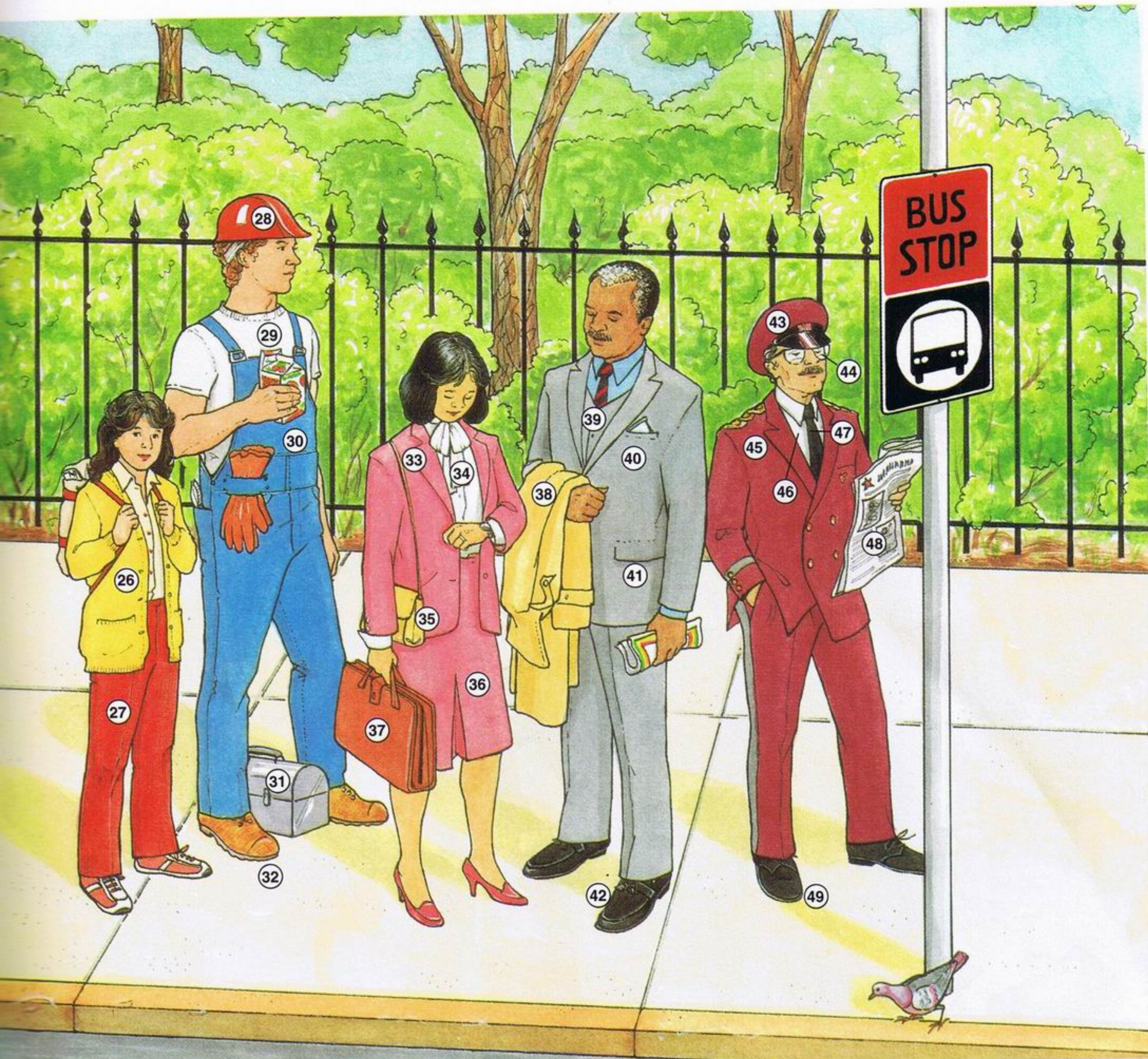

- |          |     |                      |         |     |                  |       |     |           |
|----------|-----|----------------------|---------|-----|------------------|-------|-----|-----------|
| 冷衫       | 26. | cardigan             | 女裝恤衫    | 34. | blouse           | 平底輕便鞋 | 42. | loafer    |
| (燈心絨) 長褲 | 27. | (corduroy) pants     | (有帶) 手袋 | 35. | (shoulder) bag   | 制服帽   | 43. | cap       |
| 安全帽、硬帽   | 28. | hard hat             | 半截裙     | 36. | skirt            | 眼鏡    | 44. | glasses   |
| T-恤      | 29. | T-shirt              | 公事包     | 37. | briefcase        | 制服    | 45. | uniform   |
| 工作服、工作衫  | 30. | overalls             | 雨衣、雨褸   | 38. | raincoat         | 恤衫    | 46. | shirt     |
| 午餐盒      | 31. | lunch box            | 背心      | 39. | vest             | 領呔、呔  | 47. | tie       |
| (建築) 靴   | 32. | (construction) boots | 三件頭西裝   | 40. | three-piece suit | 報紙    | 48. | newspaper |
| 褸        | 33. | jacket               | 袋       | 41. | pocket           | 鞋     | 49. | shoe      |

內衣及睡衣



- 內衣 1. undershirt  
 男用短內褲 2. boxer shorts  
 內褲 3. underpants  
 運動保護褲 4. athletic supporter  
 絲襪 5. pantyhose  
 三個骨絲襪 6. stockings  
 長內衣褲 7. long johns  
 半截底裙 8. half slip

- 女用緊身衣 9. camisole  
 全身底裙 10. full slip  
 (比堅尼式) 11. (bikini)  
 三角褲 12. briefs  
 緊身內褲 13. bra(ssiere)  
 胸圍、乳罩 14. garter belt  
 吊襪帶

- 腰封 15. girdle  
 及膝長襪 16. knee socks  
 短襪 17. socks  
 拖鞋 18. slippers  
 睡衣 19. pajamas  
 浴袍 20. bathrobe  
 睡衣 21. nightgown



- |      |                      |       |                          |       |                    |
|------|----------------------|-------|--------------------------|-------|--------------------|
| 珠寶   | <b>A. Jewellery</b>  | 吹針    | 13. tie pin              | 刀片    | 23. razor blades   |
| 耳環   | 1. earrings          | 吹夾    | 14. tie clip             | 指甲銼   | 24. emery board    |
| 戒指   | 2. ring(s)           | 夾的耳環  | 15. clip-on earring      | 指甲油   | 25. nail polish    |
| 訂婚戒指 | 3. engagement ring   | 穿耳耳環  | 16. pierced earring      | 眉筆    | 26. eyebrow pencil |
| 結婚戒指 | 4. wedding ring      | 扣     | 17. clasp                | 香水    | 27. perfume        |
| 鍊    | 5. chain             | 針     | 18. post                 | 睫毛液   | 28. mascara        |
| 項鍊   | 6. necklace          | 托     | 19. back                 | 口紅、唇膏 | 29. lipstick       |
| 珠鍊   | 7. (string of) beads | 梳洗用品及 | <b>B. Toiletries and</b> | 眼影    | 30. eye shadow     |
| 胸針   | 8. pin               | 化妝品   | <b>Makeup</b>            | 指甲鉗   | 31. nail clippers  |
| 手鍊   | 9. bracelet          | 鬚刨    | 20. razor                | 胭脂    | 32. blush          |
| 手錶   | 10. watch            | 鬚後水   | 21. after-shave lotion   | 眼線筆   | 33. eyeliner       |
| 錶帶   | 11. watchband        | 剃鬚膏   | 22. shaving cream        |       |                    |
| 袖扣鈕  | 12. cuff links       |       |                          |       |                    |

形容服裝



- 短 1. short
- 長 2. long
- 緊 3. tight
- 鬆 4. loose
- 骯髒 5. dirty
- 乾淨 6. clean
- 小 7. small
- 大 8. big

- 淺 9. light
- 深 10. dark
- 高 11. high
- 矮 12. low
- 新 13. new
- 舊 14. old
- 打開 15. open

- 關閉 16. closed
- 條紋 17. striped
- 格仔 18. checked
- 圓點 19. polka dot
- 淨色 20. solid
- 印花 21. print
- (粗幼顏色不一的) 格仔 22. plaid



- 洗衣機 1. washer
- 硬幣滑入槽 2. coin slide
- 乾洗機 3. dryer
- 硬幣投入槽 4. coin slot
- 溫度選擇 5. temperature select
- 洗衣籃 6. laundry basket
- 洗衣粉 7. laundry detergent
- 漂白水 8. bleach
- 衣物柔軟劑 9. fabric softener
- 熨斗 10. iron
- 熨衫板 11. ironing board
- 漿衫噴劑 12. spray starch

- 找換機/ 找續機 13. change machine
- 衣架 14. clothes rack
- 衣架 15. hanger
- 收銀機 16. cash register
- 衣服洗滌 標籤 17. washing
- 漂白 18. bleaching
- 乾衣 19. drying

**Clothing Care Labels**

- 熨衫、熨衣服 20. ironing
- 乾洗 21. dry clean
- “切勿” 22. “do not”

洗衣服用的  
動詞、洗衫用的  
動詞  
放入  
取出  
摺  
熨

**Laundry Verbs**

- a. load
- b. unload
- c. fold
- d. iron

形容天氣

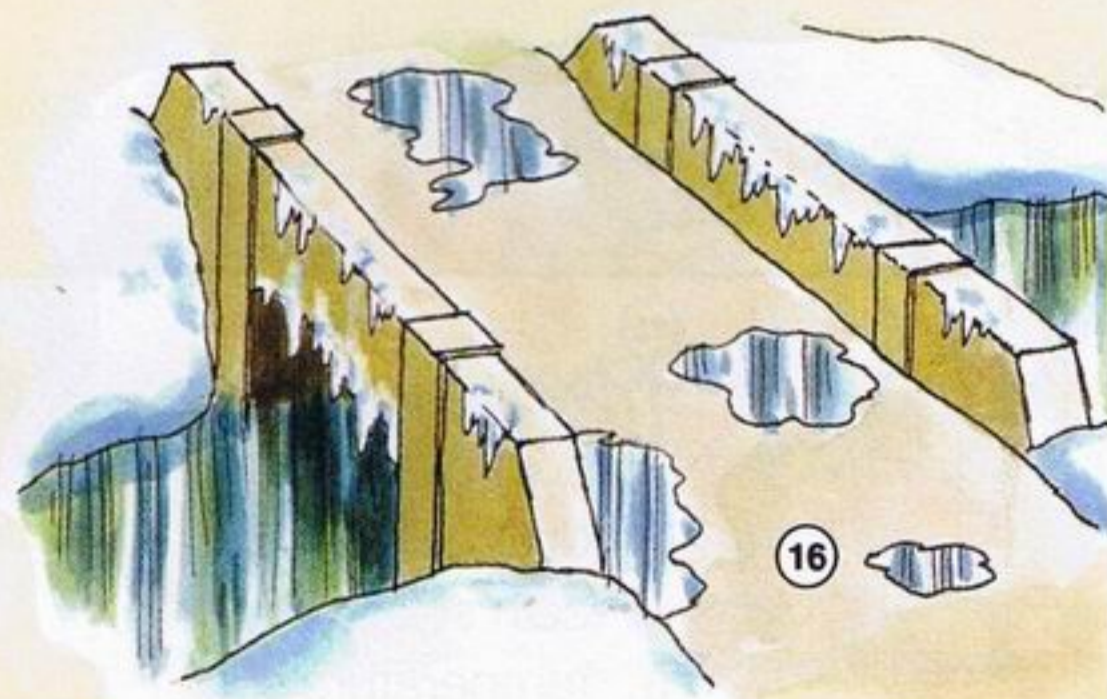
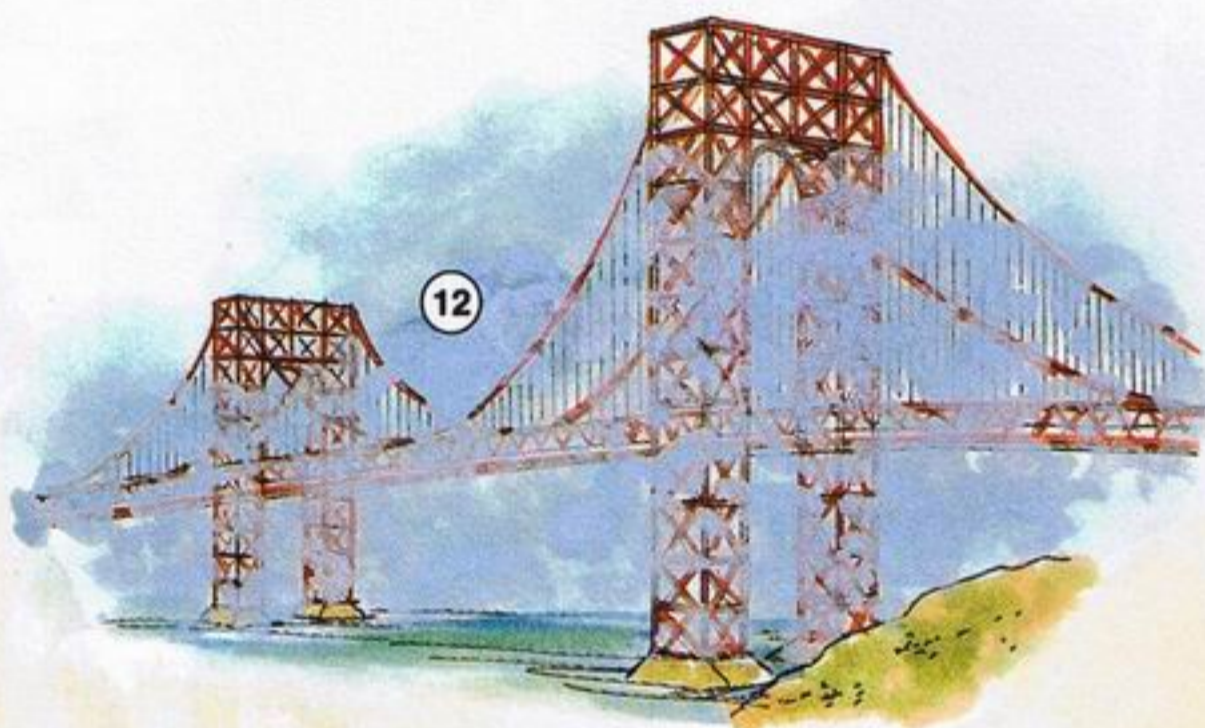
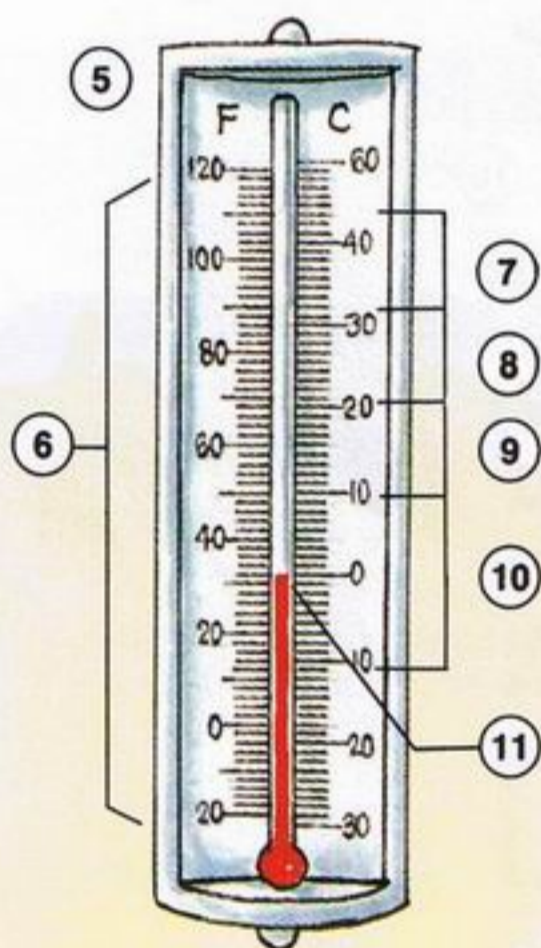

- 落雨 1. rainy
- 多雲 2. cloudy
- 落雪 3. snowy
- 晴朗 4. sunny
- 寒暑表、溫度計 5. thermometer
- 溫度 6. temperature

- 熱 7. hot
- 暖 8. warm
- 涼爽 9. cool
- 寒冷 10. cold
- 冰凍 11. freezing

- 多霧 12. foggy
- 大風 13. windy
- 乾燥 14. dry
- 潮濕 15. wet
- 冰天雪地 16. icy

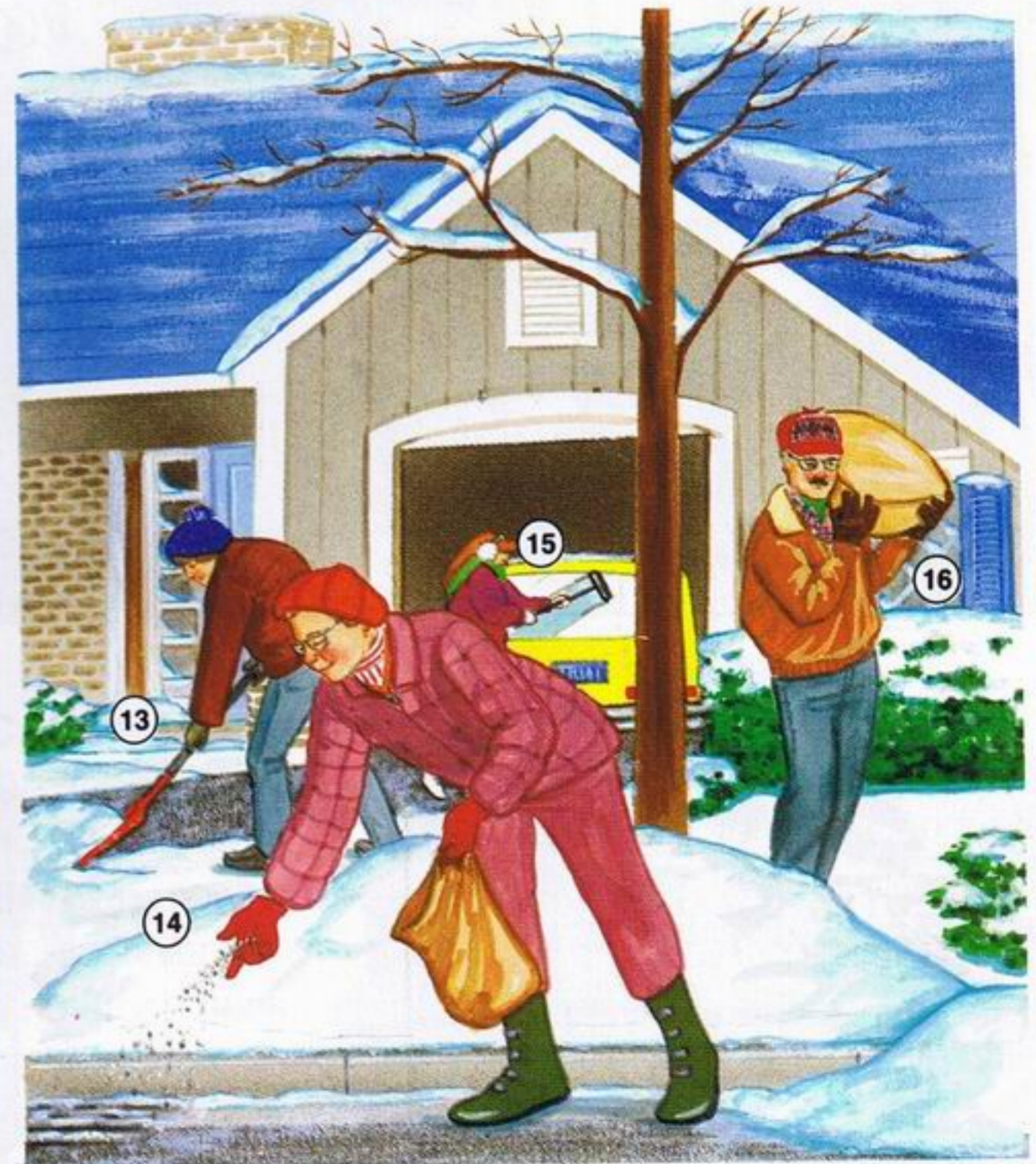
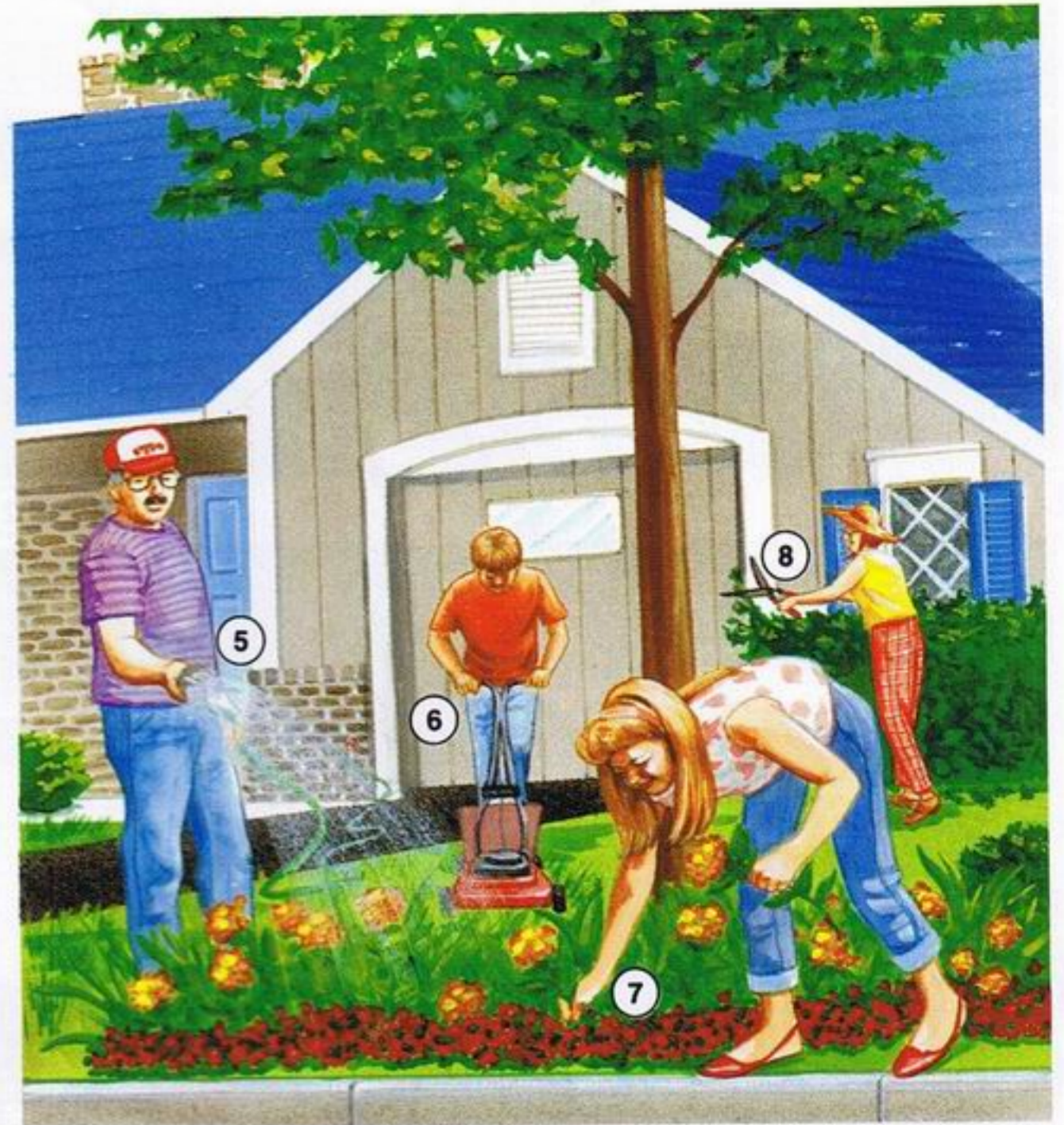
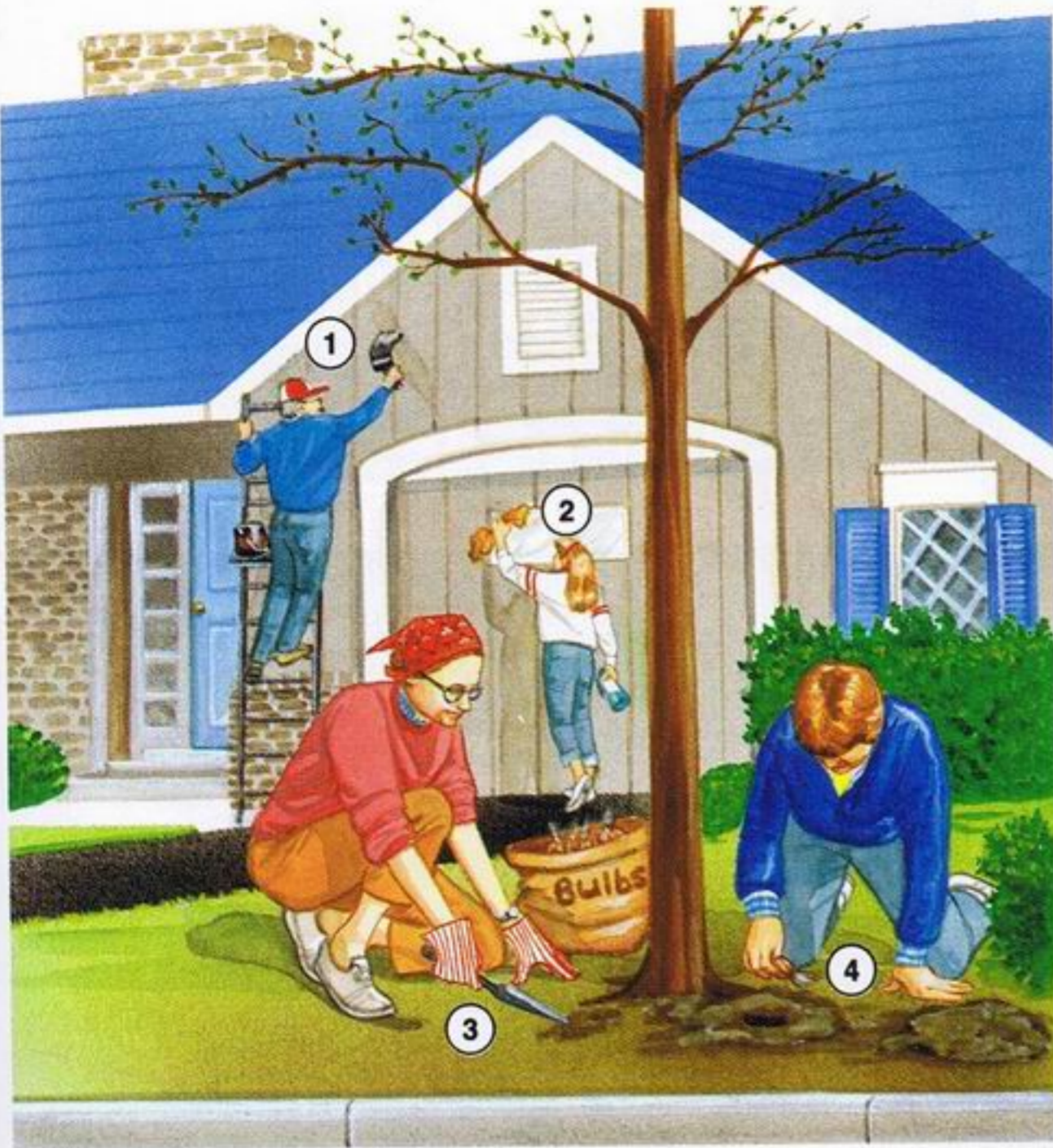

春天 **Spring**  
 油漆 1. paint  
 清洗 2. clean  
 掘 3. dig  
 種、種植 4. plant

夏天 **Summer**  
 淋水 5. water  
 割草、剪草 6. mow  
 拔 7. pick  
 修剪 8. trim

秋天 **Fall**  
 裝 9. fill  
 耙 10. rake  
 斬 11. chop  
 推 12. push

冬天 **Winter**  
 剷雪 13. shovel  
 沙/鹽 14. sand/salt  
 刮 15. scrape  
 抬 16. carry

居住地方



①



②



③



④



⑤



⑥



⑦



⑧

獨立單位大廈 1. apartment building  
多戶式大廈 2. condominium

城市屋 3. townhouse  
半連式房屋 4. semi-detached  
雙併式房屋 5. duplex

平房 6. bungalow  
分層式房屋 7. split-level house  
兩層樓房屋 8. two story house



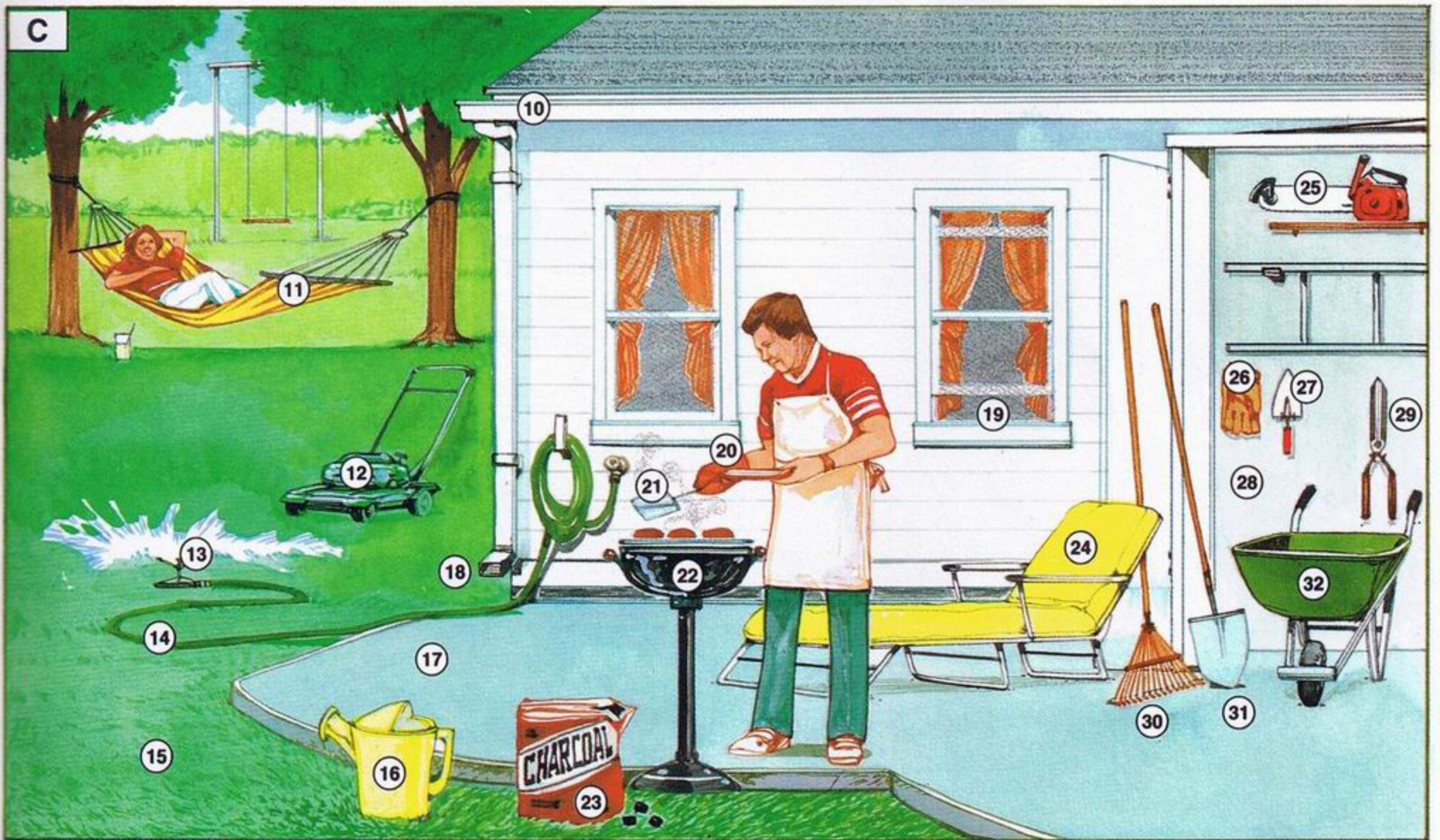
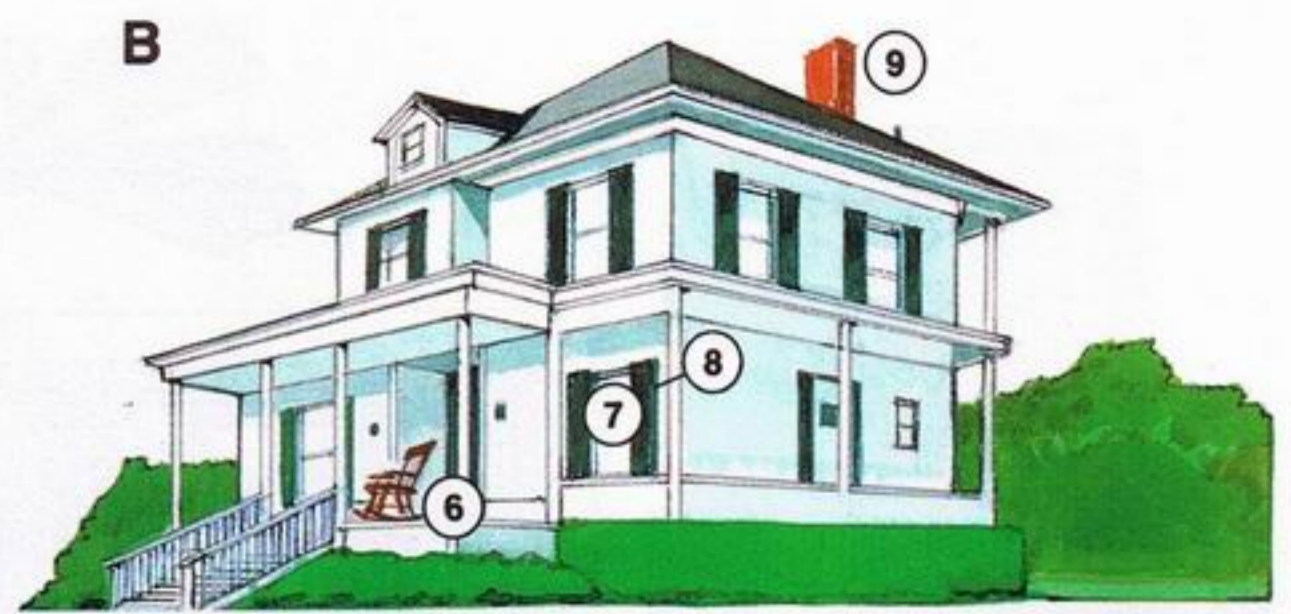
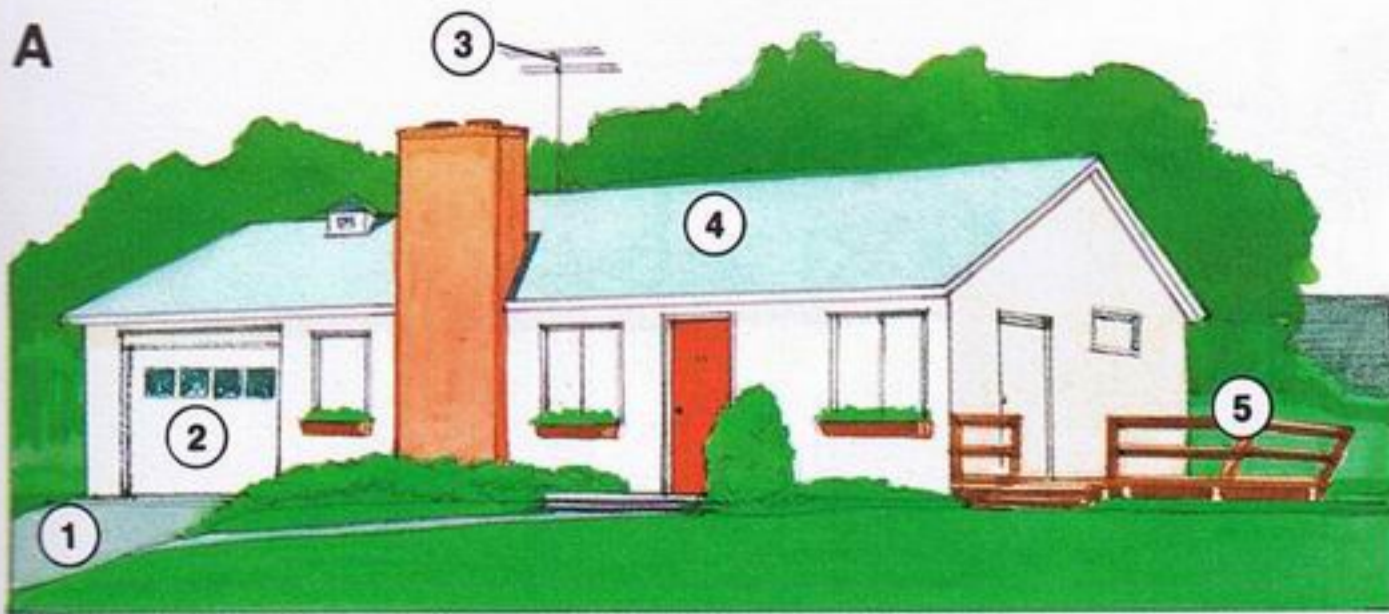

- 牧場式房屋 **A. Ranch House**  
 車路、行車路 1. driveway  
 車房 2. garage  
 電視天線 3. TV antenna  
 屋頂 4. roof  
 平台 5. deck

- 殖民式房屋 **B. Colonial-style House**  
 露台 6. porch  
 窗戶 7. window  
 百葉窗 8. shutter  
 煙囪 9. chimney

- 後院 **C. The Backyard**  
 排水管 10. gutter  
 吊床 11. hammock  
 鋤草機、剪草機 12. lawn mower  
 灑水頭 13. sprinkler  
 花園專用膠喉 14. garden hose  
 草地 15. grass  
 淋花壺、壺 16. watering can  
 天井台 17. patio  
 引水管 18. drainpipe  
 紗窗 19. screen  
 手套 20. mitt

- 鏟 21. spatula  
 燒烤爐 22. grill  
 炭煤球 23. charcoal briquettes  
 躺椅 24. lounge chair  
 電鋸 25. power saw  
 工作手套 26. work gloves  
 泥鏟 27. trowel  
 工具房 28. toolshed  
 樹剪 29. hedge-clippers  
 耙 30. rake  
 鏟 31. shovel  
 泥水車、運泥車 32. wheelbarrow

## 客廳



- |      |                |        |                               |         |                                 |
|------|----------------|--------|-------------------------------|---------|---------------------------------|
| 吊扇   | 1. ceiling fan | 樓梯     | 12. staircase                 | 喇叭      | 21. speaker                     |
| 天花板  | 2. ceiling     | 梯級     | 13. step                      | 書架      | 22. bookcase                    |
| 牆    | 3. wall        | 書枱     | 14. desk                      | 窗簾      | 23. drapes                      |
| 畫架   | 4. frame       | 牆對牆地毯  | 15. wall-to-wall<br>carpeting | 咕啞      | 24. cushion                     |
| 畫    | 5. painting    | 安樂椅    | 16. recliner                  | 梳化/長梳化椅 | 25. sofa/couch/<br>chesterfield |
| 花樽   | 6. vase        | 遙控器、遙控 | 17. remote control            | /睡椅     |                                 |
| 火爐面  | 7. mantel      | 電視     | 18. television                | 茶几      | 26. coffee table                |
| 火爐   | 8. fireplace   | 組合櫃    | 19. wall unit                 | 燈罩      | 27. lampshade                   |
| 火    | 9. fire        | 音響系統   | 20. stereo system             | 燈       | 28. lamp                        |
| 原木   | 10. log        |        |                               | 茶几仔     | 29. end table                   |
| 樓梯扶手 | 11. banister   |        |                               |         |                                 |

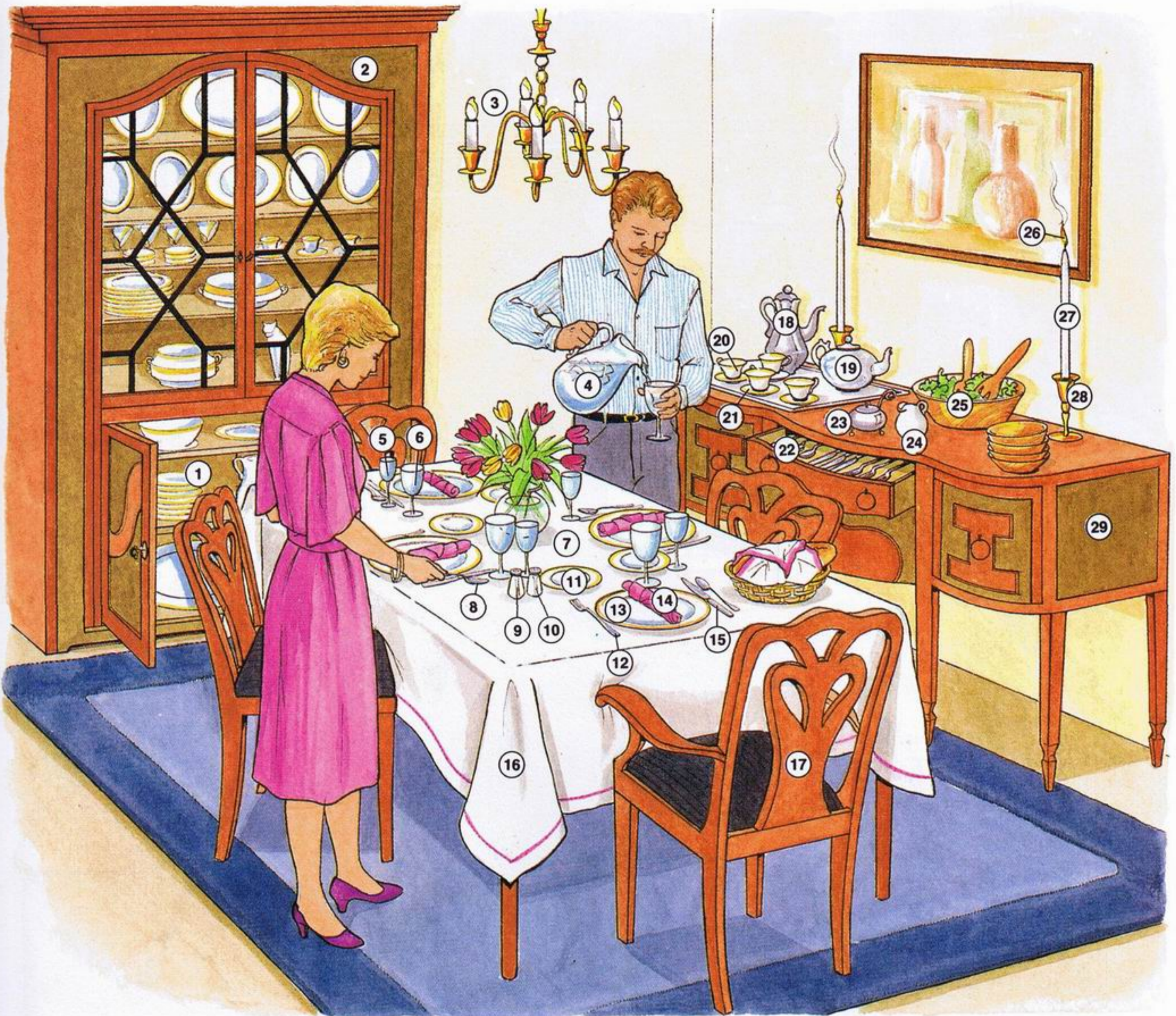

- 瓷器  
瓷器櫃/  
碗碟櫃  
吊燈  
水壺  
酒杯  
水杯  
枱  
匙羹  
胡椒樽  
鹽樽
1. china
  2. china cabinet/cupboard
  3. chandelier
  4. pitcher
  5. wine glass
  6. water glass
  7. table
  8. spoon
  9. pepper shaker
  10. salt shaker

- 麵包及  
牛油碟  
叉  
碟  
餐巾  
刀  
枱布  
椅、櫈  
咖啡壺  
茶壺  
茶杯、杯子
11. bread and butter plate
  12. fork
  13. plate
  14. napkin/serviette
  15. knife
  16. tablecloth
  17. chair
  18. coffeepot
  19. teapot
  20. cup

- 碟、  
茶杯碟  
銀器  
糖盅  
奶壺  
沙律碗、  
沙律筲  
火焰  
蠟燭  
蠟燭臺  
自助餐
21. saucer
  22. silverware
  23. sugar bowl
  24. creamer
  25. salad bowl
  26. flame
  27. candle
  28. candlestick
  29. buffet

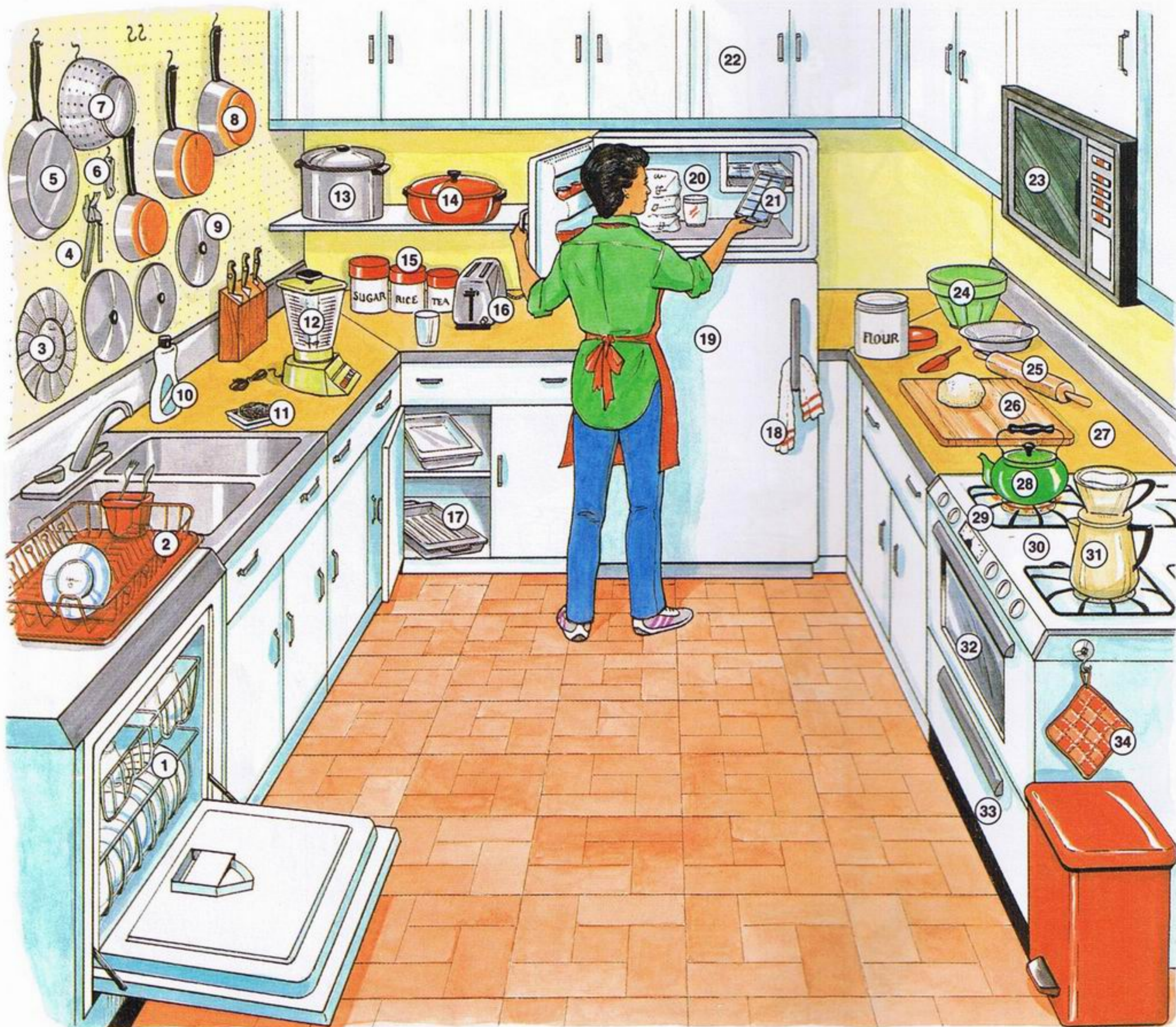

- 洗碗機 1. dishwasher  
 碗碟架 2. dish drainer  
 蒸架 3. steamer  
 罐頭刀 4. can opener  
 平底鑊 5. frying pan  
 開汽水刀 6. bottle opener  
 過濾筲 7. colander  
 有柄煲 8. saucepan  
 蓋 9. lid  
 洗潔精 10. dishwashing liquid  
 百潔布 11. scouring pad  
 攪拌機 12. blender

- 煲 13. pot  
 瓦撈 14. casserole dish  
 罐 15. canister  
 多士爐 16. toaster  
 焗盤 17. roasting pan  
 抹碗布 18. dish towel  
 雪櫃 19. refrigerator  
 雪格 20. freezer  
 冰格 21. ice tray  
 碗碟櫃 22. cabinet/cupboard  
 微波爐 23. microwave oven

- 攪拌碗 24. mixing bowl  
 碌麵棍 25. rolling pin  
 砧板 26. cutting board  
 廚房櫃台 27. counter  
 茶煲 28. teakettle  
 爐頭 29. burner  
 煮食爐 30. stove  
 咖啡壺 31. coffeemaker  
 焗爐 32. oven  
 焙箱、焙爐 33. broiler  
 隔熱墊 34. pot holder



①



②



③



④



⑤

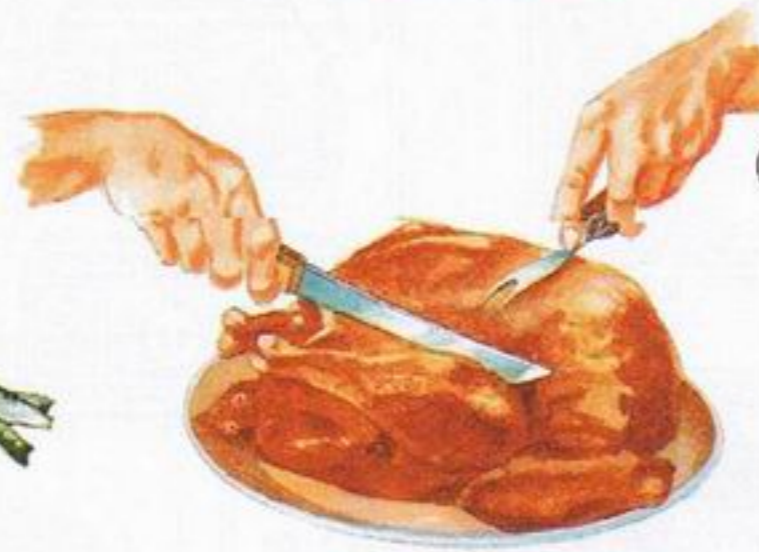

⑥



⑦



⑧



⑨

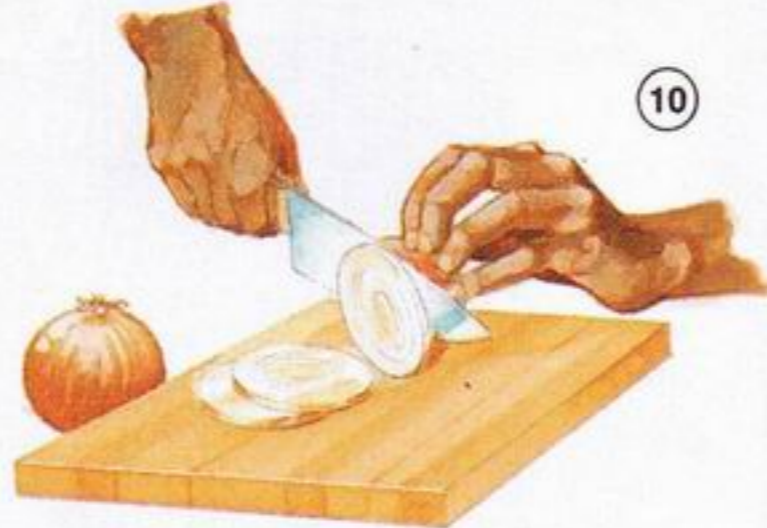

⑩



⑪



⑫

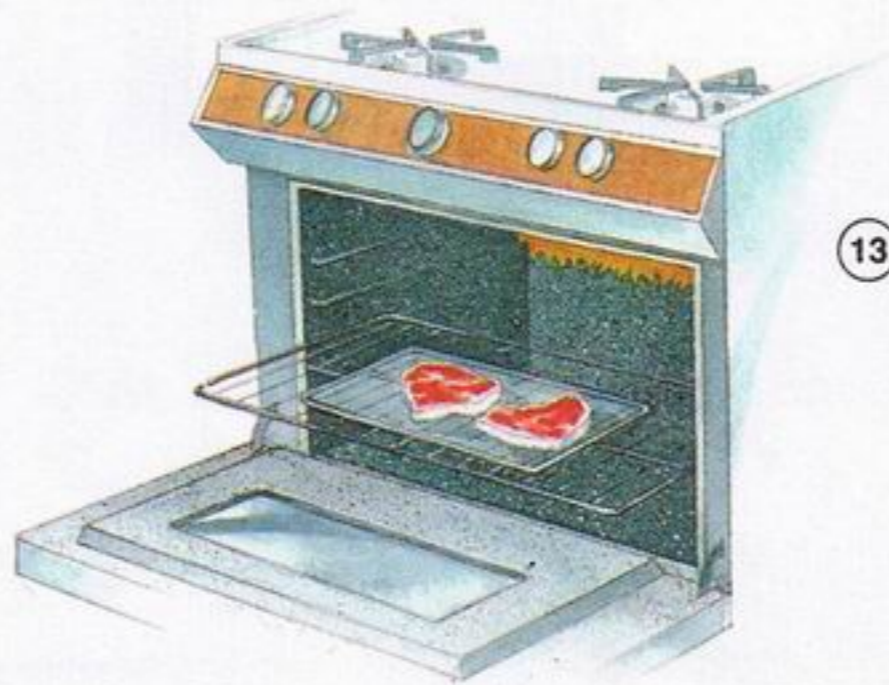

⑬



⑭



⑮



⑯

攪 1. stir  
磨、磨碎 2. grate  
開 3. open  
倒 4. pour  
剝皮 5. peel  
切 6. carve

打 7. break  
打 8. beat  
切 9. cut  
切片 10. slice  
剝 11. chop

蒸 12. steam  
焙 13. broil  
焗 14. bake  
煎 15. fry  
煲 16. boil

## 睡房



- |     |                     |       |                  |     |                      |
|-----|---------------------|-------|------------------|-----|----------------------|
| 鈎   | 1. hook             | 百葉窗   | 12. blinds       | 床單  | 23. bedspread        |
| 衣架  | 2. hanger           | 面紙、紙巾 | 13. tissues      | 床腳架 | 24. footboard        |
| 衣櫃  | 3. closet           | 床頭板   | 14. headboard    | 燈掣  | 25. light switch     |
| 首飾盒 | 4. jewellery box    | 枕頭套   | 15. pillowcase   | 電話  | 26. phone            |
| 鏡   | 5. mirror           | 枕頭    | 16. pillow       | 電話線 | a. chord             |
| 梳   | 6. comb             | 床褥    | 17. mattress     | 插頭  | b. jack              |
| 頭刷  | 7. hairbrush        | 彈簧、彈弓 | 18. box spring   | 床頭几 | 27. night table      |
| 鬧鐘  | 8. alarm clock      | 床單    | 19. (flat) sheet | 地毯  | 28. rug              |
| 櫃桶  | 9. bureau           | 毯     | 20. blanket      | 地板  | 29. floor            |
| 窗簾  | 10. curtain         | 床     | 21. bed          | 五桶櫃 | 30. chest of drawers |
| 冷氣機 | 11. air conditioner | 被     | 22. comforter    |     |                      |



- |         |                       |        |                    |       |                    |
|---------|-----------------------|--------|--------------------|-------|--------------------|
| 窗簾      | 1. shade              | 尿布     | 13. cloth diaper   | 學行車   | 23. walker         |
| 活動懸掛玩具  | 2. mobile             | 嬰兒手推車、 | 14. stroller       | 鞦韆    | 24. swing          |
| 玩具熊     | 3. teddy bear         | 嬰兒車    |                    | 玩具房屋  | 25. doll house     |
| 嬰兒床     | 4. crib               | 煙火警報器  | 15. smoke detector | 搖籃    | 26. cradle         |
| 嬰兒床側墊   | 5. bumper             | 搖椅     | 16. rocking chair  | 布公仔   | 27. stuffed animal |
| 嬰兒露     | 6. baby lotion        | 奶樽     | 17. bottle         | 洋娃娃   | 28. doll           |
| 爽身粉、痲子粉 | 7. baby powder        | 奶嘴     | 18. nipple         | 玩具箱   | 29. toy chest      |
| 嬰兒濕布    | 8. baby wipes         | 嬰兒睡衣   | 19. sleeper        | 嬰兒圍欄  | 30. playpen        |
| 換尿布枱    | 9. changing table     | 口水肩    | 20. bib            | 拼圖    | 31. puzzle         |
| 棉花棒     | 10. cotton swab       | 響鈴     | 21. rattle         | 積木    | 32. block          |
| 扣針      | 11. safety pin        | 奶嘴     | 22. pacifier       | 嬰兒用廁所 | 33. potty          |
| 紙尿片     | 12. disposable diaper |        |                    |       |                    |

## 浴室



- |     |                   |      |                       |     |                  |
|-----|-------------------|------|-----------------------|-----|------------------|
| 帘架  | 1. curtain rod    | 浴墊   | 12. bath mat          | 抹布  | 23. hand towel   |
| 帘環  | 2. curtain rings  | 垃圾桶  | 13. wastepaper basket | 浴巾  | 24. bath towel   |
| 浴帽  | 3. shower cap     | 醫藥櫃  | 14. medicine chest    | 毛巾架 | 25. towel rack   |
| 花灑頭 | 4. shower head    | 肥皂   | 15. soap              | 風筒  | 26. hair dryer   |
| 浴帘  | 5. shower curtain | 牙膏   | 16. toothpaste        | 瓷磚  | 27. tile         |
| 肥皂碟 | 6. soap dish      | 熱水水喉 | 17. hot water faucet  | 洗衣籃 | 28. hamper       |
| 海綿  | 7. sponge         | 冷水水喉 | 18. cold water faucet | 廁所  | 29. toilet       |
| 洗頭水 | 8. shampoo        | 瓷盤   | 19. sink              | 廁紙  | 30. toilet paper |
| 出水口 | 9. drain          | 指甲刷  | 20. nailbrush         | 廁所刷 | 31. toilet brush |
| 活塞  | 10. stopper       | 牙刷   | 21. toothbrush        | 磅   | 32. scale        |
| 浴缸  | 11. bathtub       | 毛巾仔  | 22. washcloth         |     |                  |



## 儲藏家庭用具及供應品的房間



- |        |                    |        |                    |        |                                  |
|--------|--------------------|--------|--------------------|--------|----------------------------------|
| 人字梯    | 1. step ladder     | 膠手套    | 13. rubber gloves  | 油漆     | 26. paint                        |
| 雞毛掃    | 2. feather duster  | 通廁所泵   | 14. plunger        | 產品危險標籤 | 27. <b>Product Hazard Labels</b> |
| 電筒     | 3. flashlight      | 水桶     | 15. pail/bucket    | 小心     | 28. caution                      |
| 碎布     | 4. rags            | 吸塵機    | 16. vacuum cleaner | 警告     | 29. warning                      |
| 斷路器    | 5. circuit breaker | 配件     | 17. attachments    | 危險     | 30. danger                       |
| 海綿地拖   | 6. sponge mop      | 管      | 18. pipes          | 腐蝕性    | 31. corrosive                    |
| 掃把     | 7. broom           | 垃圾桶    | 19. garbage can    | 能夠刺激眼睛 | 32. eye irritant                 |
| 垃圾畚    | 8. dustpan         | 老鼠夾    | 20. mouse trap     | 有毒     | 33. poison                       |
| 清潔劑    | 9. cleanser        | 曬衫繩    | 21. clothes line   | 易燃     | 34. flammable                    |
| 玻璃清潔劑  | 10. glass cleaner  | 衣夾     | 22. clothes pins   | 具爆炸性   | explosive (if shaken,            |
| 焗爐清潔劑  | 11. oven cleaner   | 大紙巾    | 23. paper towels   | (如搖晃、  | dropped, or heated)              |
| 海綿     | 12. sponge         | 電燈泡、燈膽 | 24. light bulbs    | 掉落或受熱) |                                  |
| (更換地拖) | (mop refill)       | 油漆稀劑   | 25. paint thinner  |        |                                  |

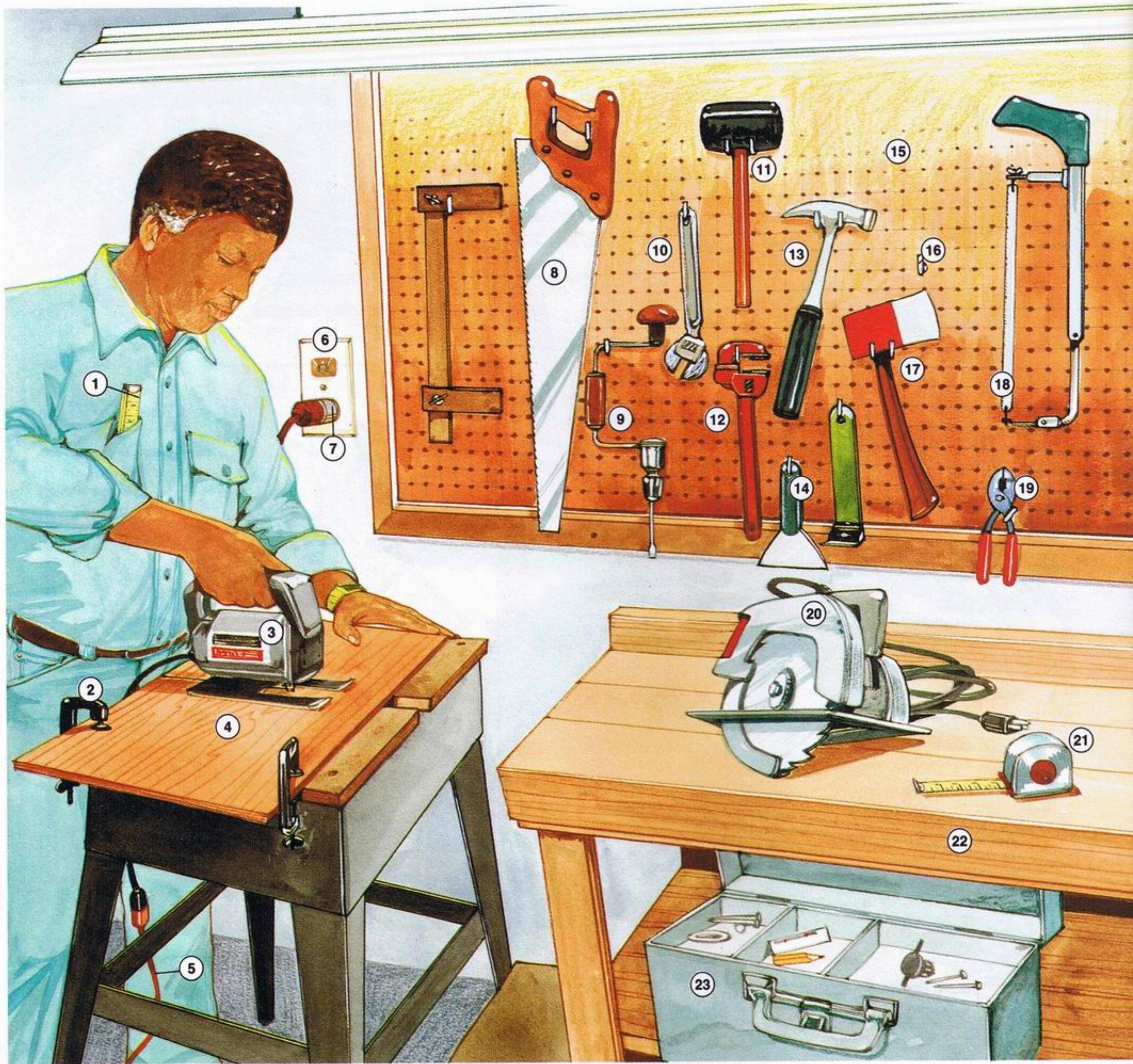

- 木匠尺 1. carpenter's rule
- 咬合鉗 2. C-clamp
- 細鋸 3. jigsaw
- 木 4. wood
- 電線延長線 5. extension cord
- 電插座 6. outlet
- 接地插頭 7. grounding plug
- 鋸 8. saw

- 曲柄鑽 9. brace
- 扳頭 10. wrench
- 木槌 11. mallet
- 活動扳頭 12. monkey wrench
- 槌 13. hammer
- 刮刀 14. scraper
- 掛板 15. pegboard
- 鉤 16. hook

- 短柄斧頭 17. hatchet
- 弓鋸 18. hacksaw
- 鉗 19. pliers
- 圓形鋸 20. circular saw
- 軟尺 21. tape measure
- 工作枱 22. workbench
- 工具箱 23. toolbox



- |       |     |                      |      |     |                 |           |     |                           |
|-------|-----|----------------------|------|-----|-----------------|-----------|-----|---------------------------|
| 螺絲批   | 24. | screwdriver          | 膠水   | 33. | glue            | 螺絲釘       | 42. | screw                     |
| 十字批   | 25. | Phillips screwdriver | 絕緣膠紙 | 34. | electrical tape | 釘頭        | a.  | head                      |
| 電動打磨機 | 26. | power sander         | 電線   | 35. | wire            | 螺絲紋       | b.  | thread                    |
| 沙紙    | 27. | sandpaper            | 老虎鉗  | 36. | vise            | 電鑽        | 43. | electric drill            |
| 盤     | 28. | pan                  | 電刨   | 37. | router          | 鑽頭        | a.  | bit                       |
| 滾筒    | 29. | roller               | 螺絲釘  | 38. | bolt            | 軸         | b.  | shank                     |
| 油掃    | 30. | paintbrush           | 螺絲帽  | 39. | nut             | 掣         | c.  | switch                    |
| 油漆    | 31. | paint                | 圈、墊圈 | 40. | washer          | 插頭 (三腳插頭) | d.  | plug (three-pronged plug) |
| 刨     | 32. | wood plane           | 釘    | 41. | nail            |           |     |                           |

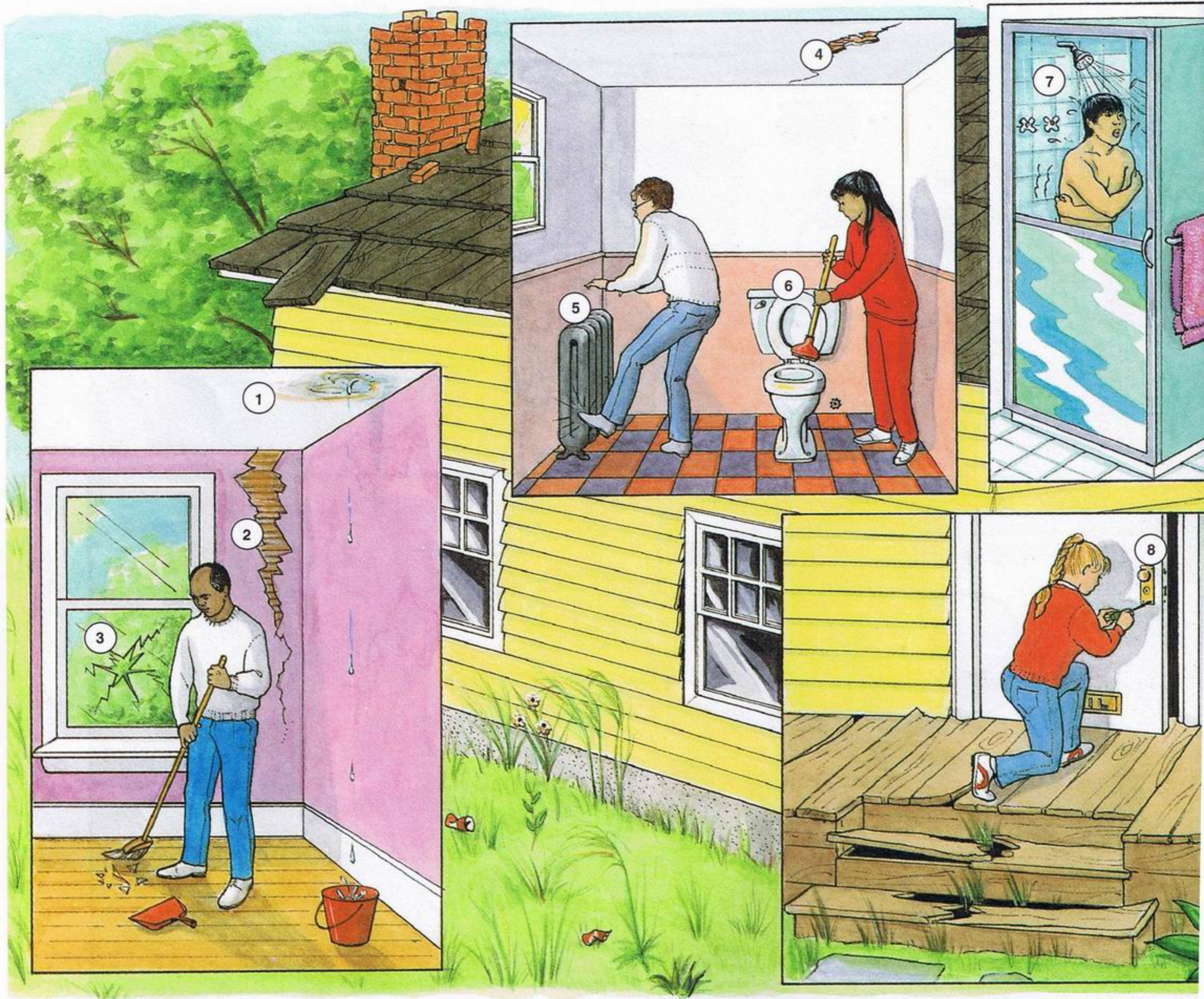

- 屋頂/天花板漏水 1. leaking roof/ceiling
- 牆壁龜裂 2. cracked wall
- 窗戶破碎 3. broken window
- 天花板龜裂 4. cracked ceiling

- 無暖氣 5. no heat
- 廁所堵塞 6. stopped-up toilet
- 無熱水 7. no hot water
- 壞鎖 8. broken lock



- 樓梯破爛 9. broken steps
- 水喉滴水 10. dripping faucet
- 排水管淤塞 11. clogged drain
- 雪櫃失靈 12. refrigerator not working

- 甲由 13. (cock) roaches
- 老鼠 14. mice
- 地牢水浸 15. flooded basement

家務及修理用詞 (動詞)



①



②



③

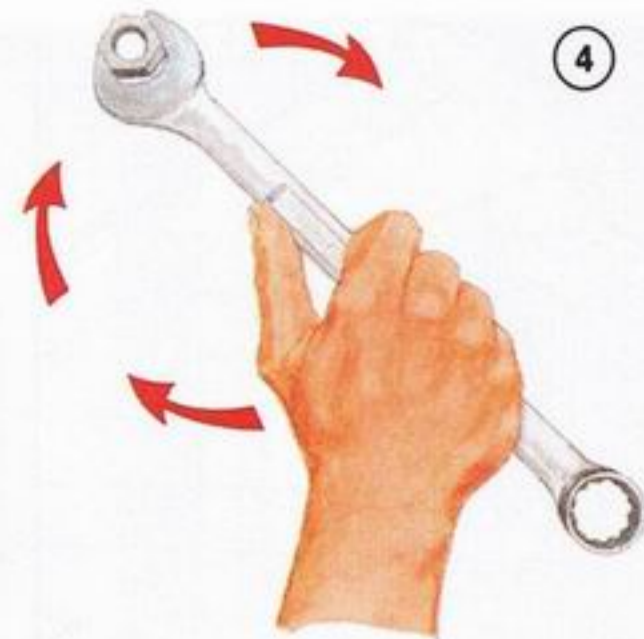

④



⑤

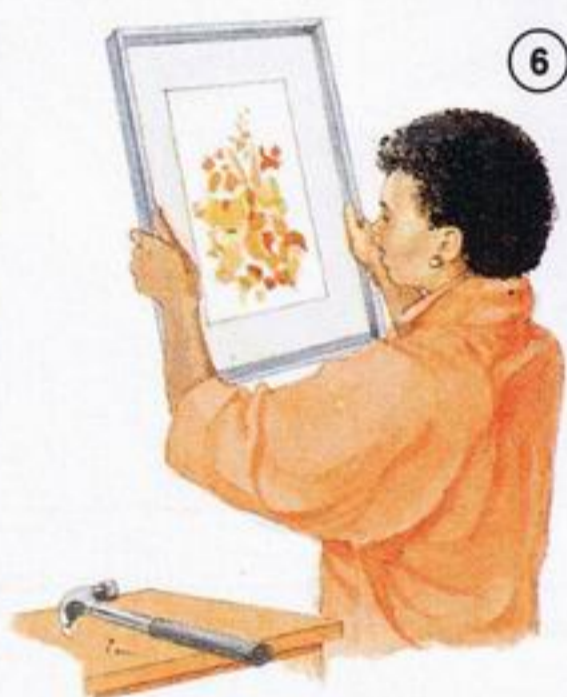

⑥



⑦



⑧



⑨



⑩



⑪



⑫



⑬



⑭



⑮



⑯

- 摺 1. fold
- 刷 2. scrub
- 擦亮 3. polish
- 扭緊 4. tighten
- 抹 5. wipe
- 掛 6. hang

- 掃 7. sweep
- 鋪 (床) 8. make (the bed)
- 抹乾 9. dry
- 修理 10. repair
- 熨 11. iron

- 加油 12. oil
- 換 (床單) 13. change (the sheets)
- 吸塵 14. vacuum
- 掃塵 15. dust
- 洗 16. wash

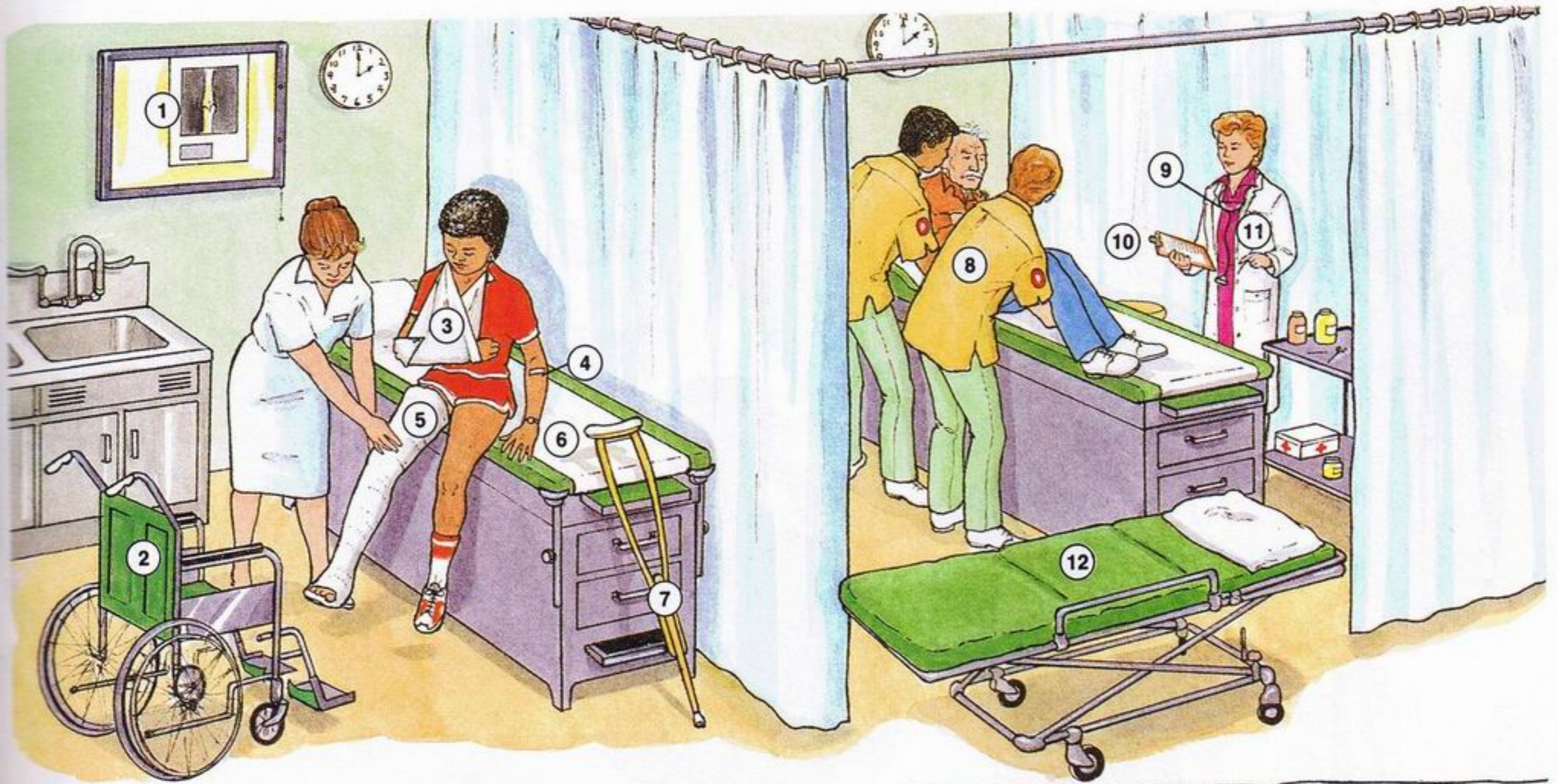

- |        |                    |         |                 |         |                     |
|--------|--------------------|---------|-----------------|---------|---------------------|
| X光     | 1. X-ray           | 病歷表     | 10. chart       | 腳掣      | 18. pedal           |
| 輪椅     | 2. wheelchair      | 醫生      | 11. doctor      | 護士      | 19. nurse           |
| 三角巾    | 3. sling           | 擔架床     | 12. stretcher   | 病人      | 20. patient         |
| 膠布     | 4. Band-Aid™       | 儀器      | 13. instruments | 縫針、聯針   | 21. stitches        |
| 石膏     | 5. cast            | 口腔保健師、  | 14. dental      | 酒精      | 22. alcohol         |
| 檢查床    | 6. examining table | 牙科衛生護士、 | hygienist/ oral | 棉花球     | 23. cotton balls    |
| 拐杖     | 7. crutch          | 口腔衛生護士  | hygienist       | (紗布) 繃帶 | 24. (gauze) bandage |
| 未經訓練的  | 8. orderlies       | 鑽       | 15. drill       | 紗布墊     | 25. gauze pads      |
| 男性護理人員 |                    | 盤       | 16. basin       | 針       | 26. needle          |
| 聽筒     | 9. stethoscope     | 牙醫      | 17. dentist     | 針筒      | 27. syringe         |



- 紅腫 1. rash
- 發燒 2. fever
- 蟲咬 3. insect bite
- 發冷 4. chills
- 黑眼圈 5. black eye
- 頭痛 6. headache
- 胃痛 7. stomachache
- 背痛、背脊痛 8. backache

- 牙痛 9. toothache
- 高血壓 10. high blood pressure
- 感冒 11. cold
- 喉嚨痛 12. sore throat
- 雪條棍 a. tongue depressor

- 扭傷 13. sprain
- 彈性繃帶 a. elastic bandage
- 感染 14. infection
- 骨折、斷骨 15. broken bone
- 割傷 16. cut
- 瘀 17. bruise
- 燙傷 18. burn



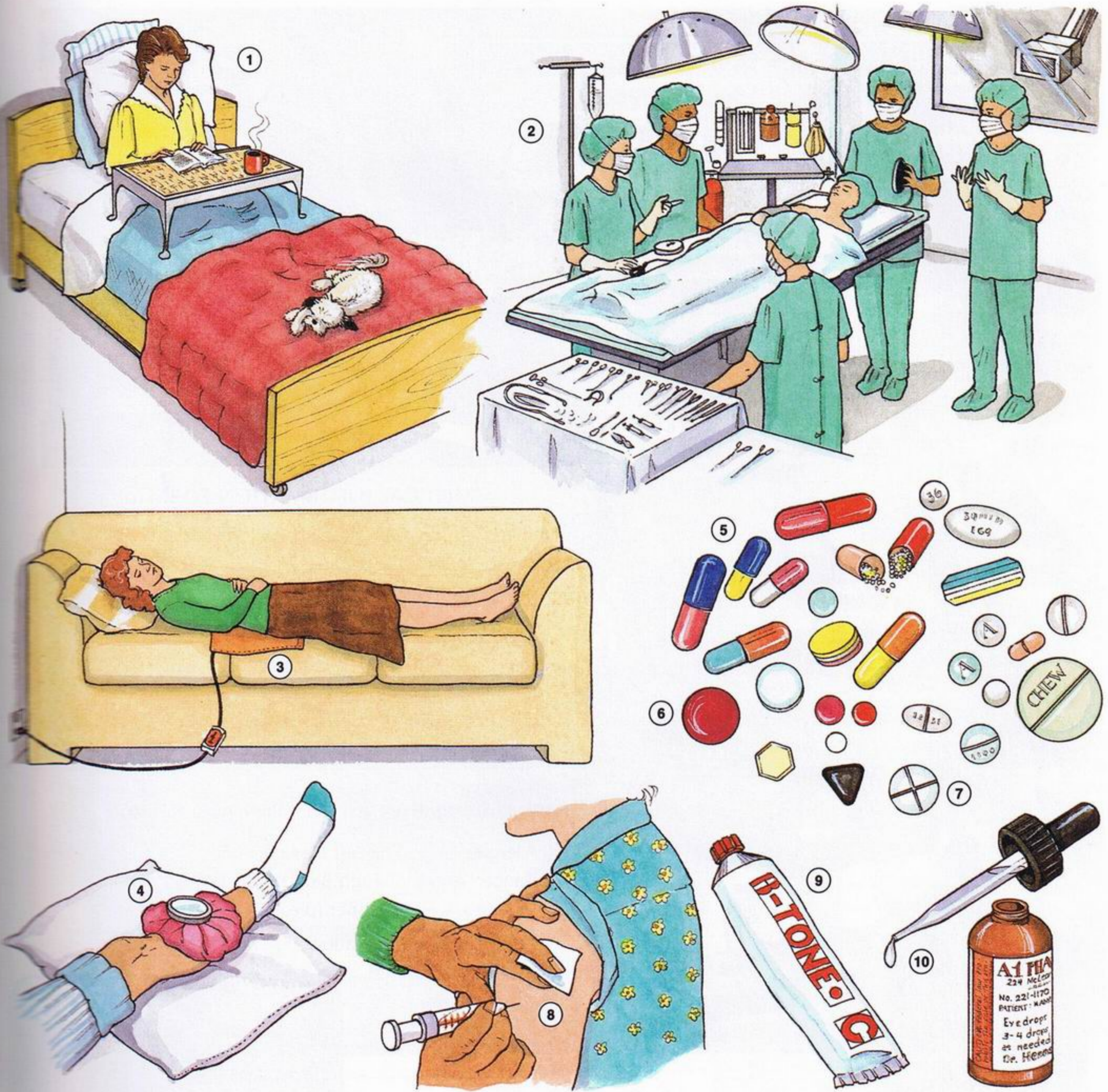

- 睡在床上休息 1. bed rest  
 手術 2. surgery  
 熱敷 3. heating pad  
 冰袋 4. ice pack

- 藥物 5. capsule  
 膠囊 6. tablet  
 藥片 7. pill  
 藥丸 8. injection  
 注射 9. ointment  
 藥膏 10. eye drops  
 眼藥水

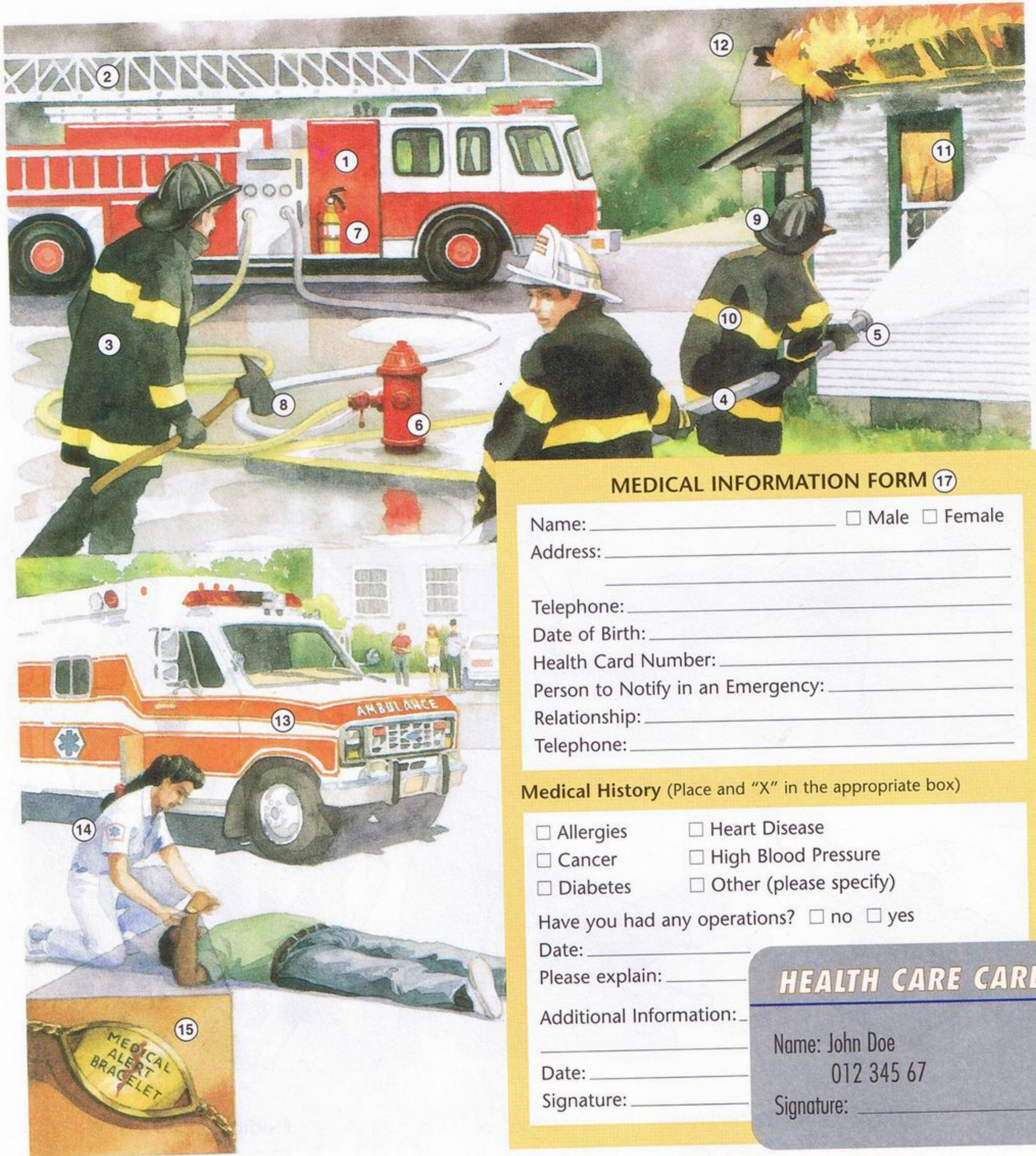

**MEDICAL INFORMATION FORM (17)**

Name: \_\_\_\_\_  Male  Female  
 Address: \_\_\_\_\_  
 Telephone: \_\_\_\_\_  
 Date of Birth: \_\_\_\_\_  
 Health Card Number: \_\_\_\_\_  
 Person to Notify in an Emergency: \_\_\_\_\_  
 Relationship: \_\_\_\_\_  
 Telephone: \_\_\_\_\_

**Medical History (Place and "X" in the appropriate box)**

- |                                    |   |
|------------------------------------|---|
| <input type="checkbox"/> Allergies | <input type="checkbox"/> Heart Disease          |
| <input type="checkbox"/> Cancer    | <input type="checkbox"/> High Blood Pressure    |
| <input type="checkbox"/> Diabetes  | <input type="checkbox"/> Other (please specify) |

Have you had any operations?  no  yes

Date: \_\_\_\_\_

Please explain: \_\_\_\_\_

Additional Information: \_\_\_\_\_

Date: \_\_\_\_\_

Signature: \_\_\_\_\_

**HEALTH CARE CARD (16)**

Name: John Doe

012 345 67

Signature: \_\_\_\_\_

救火車、火燭車、  
消防車

1. fire engine

梯、雲梯

2. ladder

消防員

3. fire fighter

水管

4. hose

噴嘴

5. nozzle

消防龍頭

6. fire hydrant

滅火器

7. fire extinguisher

斧頭

8. axe

消防員頭盔

9. helmet

消防外套、

10. coat

消防褸

火

11. fire

煙

12. smoke

救護車、十字車

13. ambulance

救護人員

14. paramedic

醫療注意手鐲

15. medical alert bracelet

醫療保險咭、

16. health insurance card

健康保險咭

健康情況表格

17. medical information form

(病歷)

(medical history)

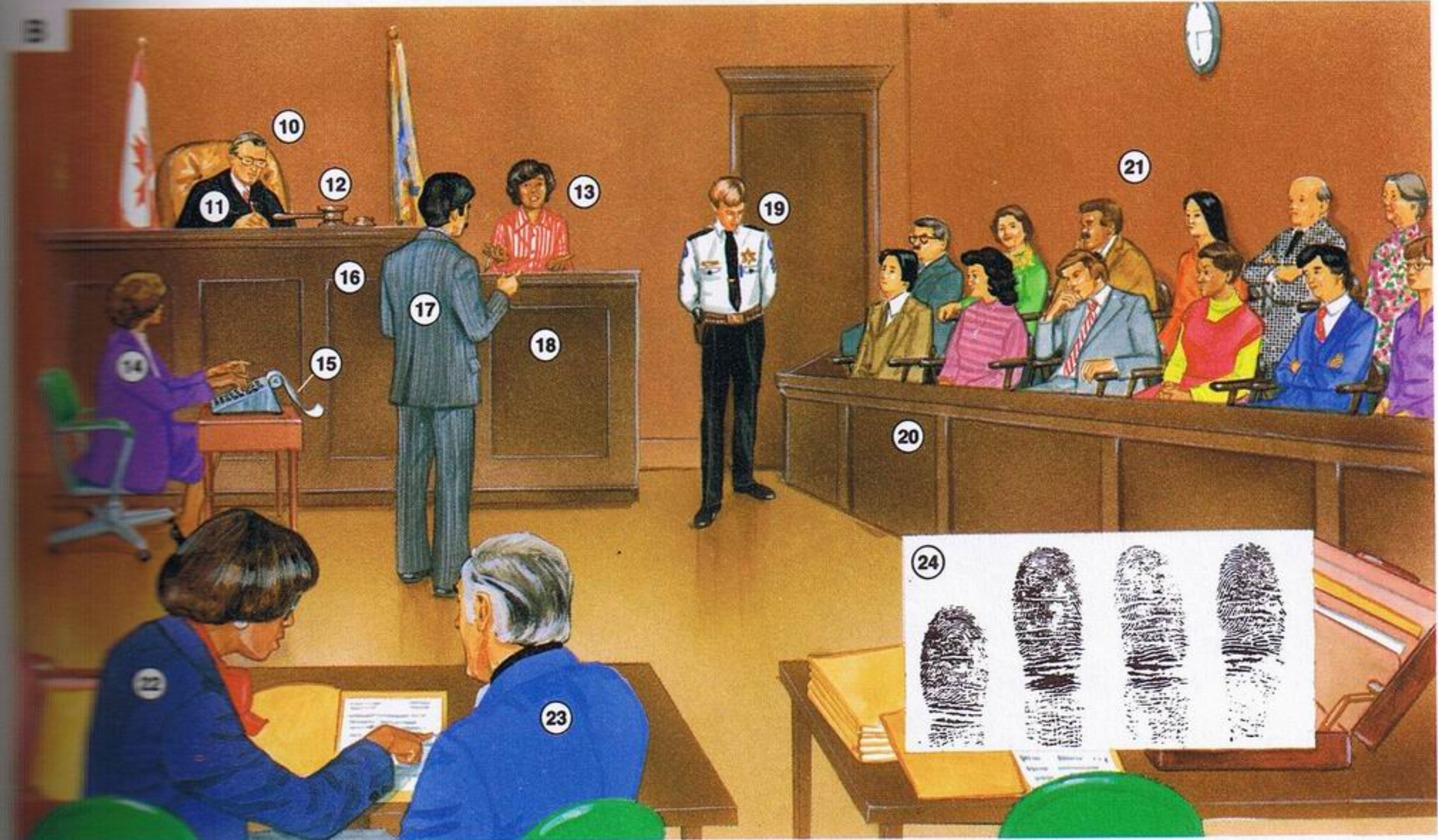
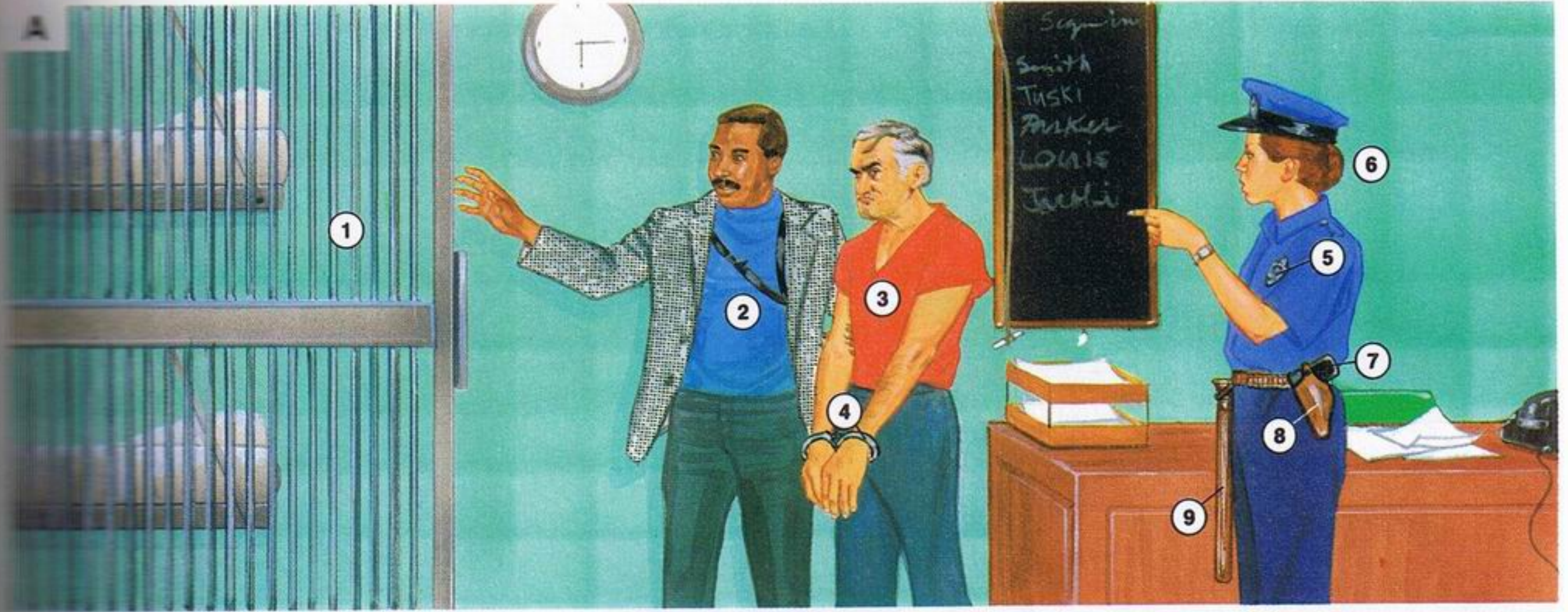

**A. Police Station**

- 1. jail
- 2. detective
- 3. suspect
- 4. handcuffs
- 5. badge
- 6. police officer
- 7. gun
- 8. holster
- 9. nightstick

**B. Court**

- 10. judge
- 11. robes
- 12. gavel
- 13. witness
- 14. court reporter
- 15. transcript
- 16. bench
- 17. crown attorney

**證人席 18. witness stand**

- 法警 19. court officer
- 陪審團席 20. jury box
- 陪審團 21. jury
- 辯護律師、 22. defense attorney
- 辯方律師
- 被告 23. defendant
- 手指模 24. fingerprints



辦公大廈、  
寫字樓大廈  
大堂  
角落  
行人輔助線  
百貨公司  
麵包鋪、餅店

1. office building  
2. lobby  
3. corner  
4. crosswalk  
5. department store  
6. bakery

公眾電話/  
投硬幣電話  
路牌  
郵局、郵政局  
交通警察  
十字路口

7. public telephone/  
pay phone  
8. street sign  
9. post office  
10. traffic cop  
11. intersection

行人  
巴士站  
長椅  
字紙籬  
地下鐵車站、  
地下鐵路車站

12. pedestrian  
13. bus stop  
14. bench  
15. trash basket  
16. subway station

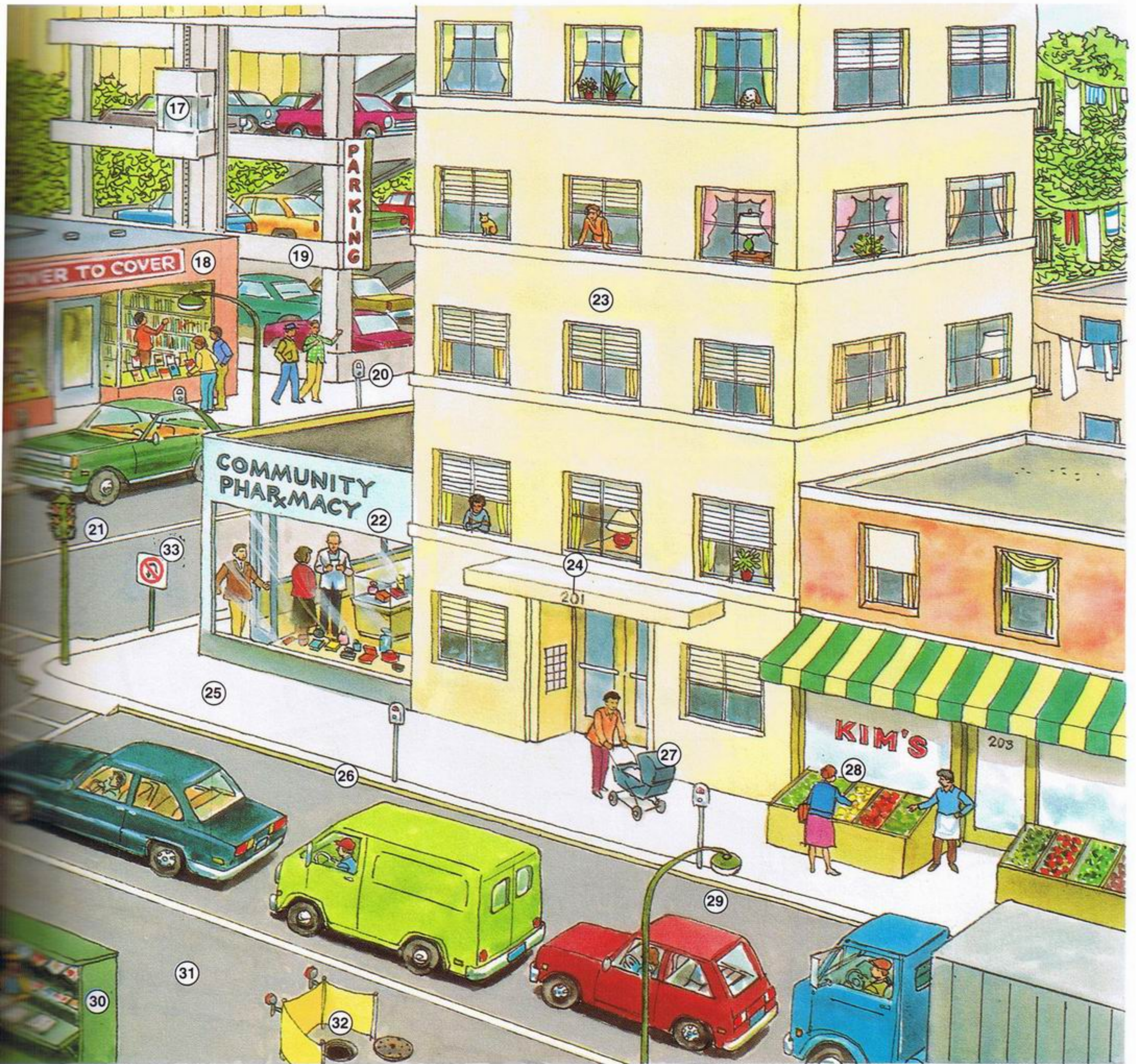

- 電梯 17. elevator  
 書店 18. bookstore  
 停車場 19. parking garage  
 停車咪表 20. parking meter  
 交通燈、紅綠燈 21. traffic light  
 藥房 22. drugstore  
 獨立單位的大廈 23. apartment building  
 大廈號碼 24. building number  
 行人路 25. sidewalk  
 路邊 26. curb

- 嬰兒手推車 27. baby carriage  
 蔬果攤 28. fruit and vegetable stand  
 街燈 29. streetlight  
 報攤、報紙攤、報紙檔 30. newsstand  
 街道 31. street  
 地下水道 32. manhole  
 檢查口

- 路牌 33. no "U" turn  
 不准掉頭  
 小心兒童 (靠近學校/公園) 34. watch for children (school/playground near)  
 由此至轉角處不准泊車 35. no parking here to corner

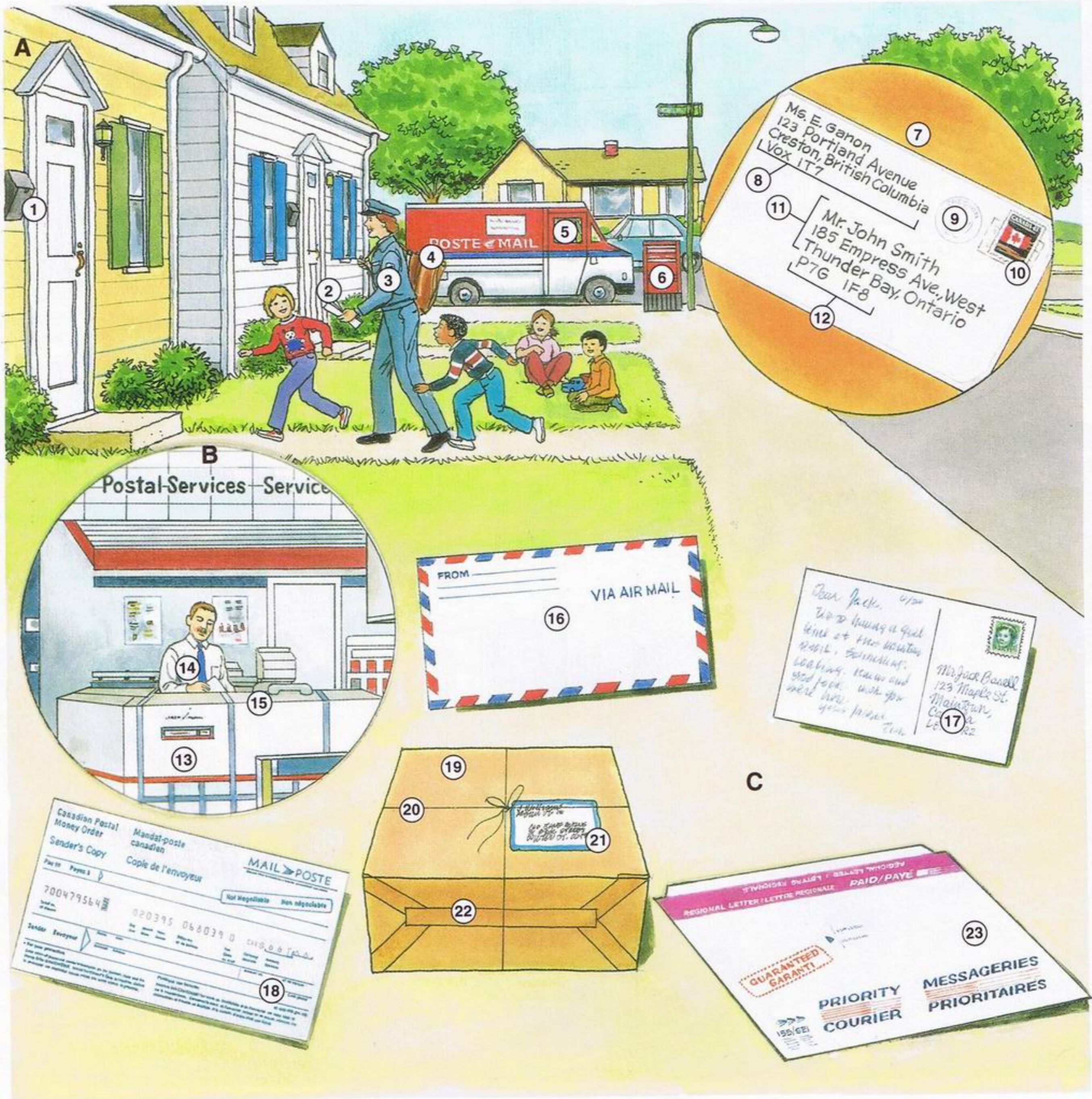

- 遞送郵件 A. Delivering Mail**
- 信箱 1. mailbox
  - 郵件 2. mail
  - 郵差 3. letter carrier
  - 郵袋 4. mailbag
  - 郵車、郵差車 5. mail truck
  - 郵箱 6. mailbox
  - 信、信件 7. letter
  - 回郵地址 8. return address

- 郵局、郵政局 B. The Post Office**
- 郵印 9. postmark
  - 郵票 10. stamp
  - 地址 11. address
  - 郵政編號 12. postal code
  - 投件口 13. mail slot
  - 郵政人員 14. postal worker
  - 窗口 15. window/wicket

- 郵件種類 C. Types of Mail**
- (空郵) 信封 16. (airmail) envelope
  - 明信片 17. postcard
  - 匯票 18. money order
  - 包裹 19. package
  - 繩 20. string
  - 標貼 21. label
  - 膠紙 22. tape
  - 快郵(速遞) 23. priority post (courier)

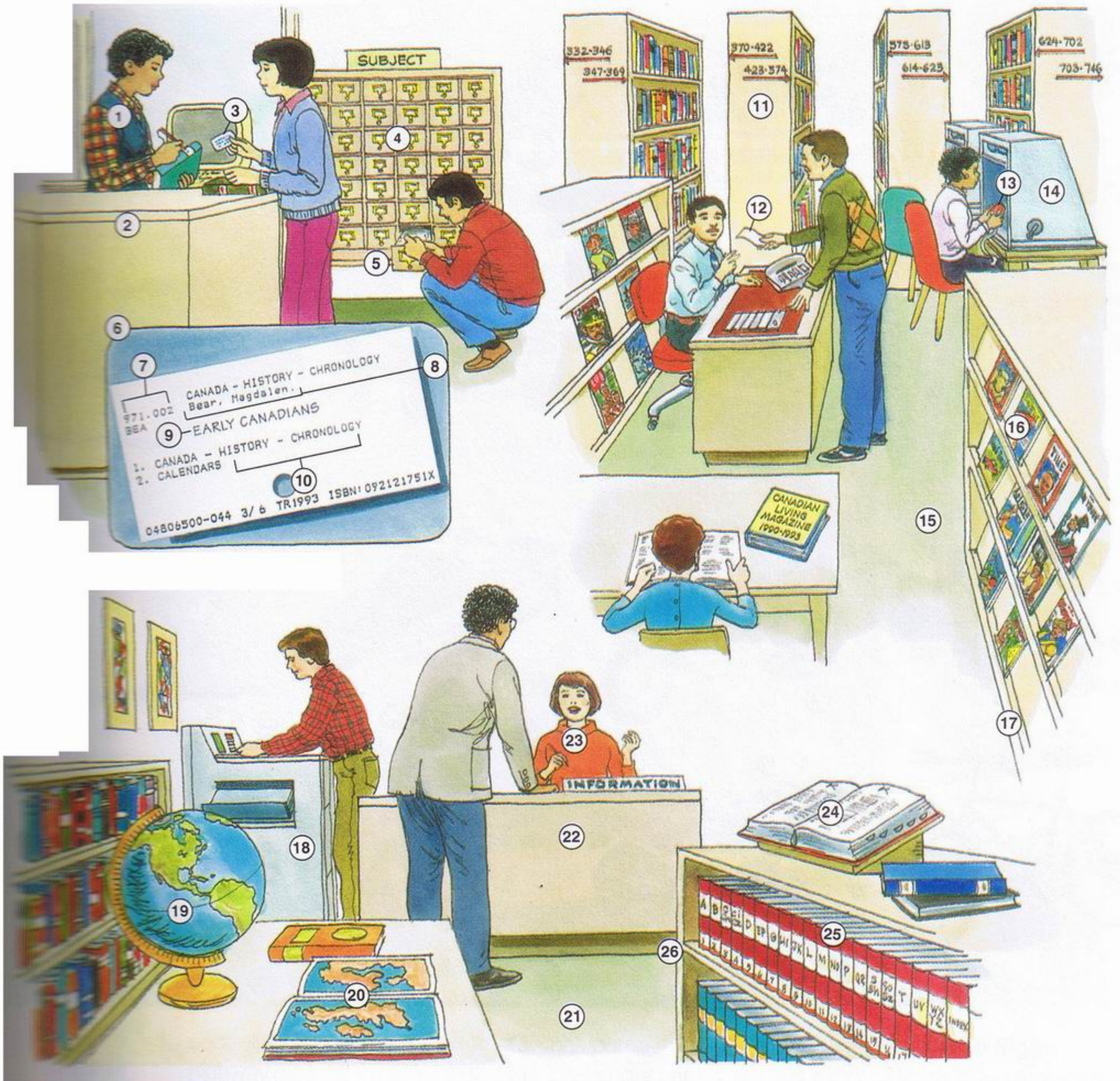

- |        |                   |         |                         |        |                       |
|--------|-------------------|---------|-------------------------|--------|-----------------------|
| 圖書館管理員 | 1. library clerk  | 主題      | 10. subject             | 地球儀    | 19. globe             |
| 借書處    | 2. checkout desk  | 排列      | 11. row                 | 地圖     | 20. atlas             |
| 圖書館證   | 3. library card   | 參考紙條    | 12. reference slip      | 參考部    | 21. reference section |
| 圖書目錄卡  | 4. card catalogue | 縮影膠片    | 13. microfilm           | 詢問處    | 22. information desk  |
| 櫃檯     | 5. drawer         | 縮影膠片閱讀機 | 14. microfilm reader    | 圖書館參考部 | 23. (reference)       |
| 索引卡    | 6. index card     | 雜誌期刊部   | 15. periodicals section | 部管理員   | librarian             |
| 書號     | 7. call number    | 雜誌      | 16. magazine            | 字典     | 24. dictionary        |
| 作者     | 8. author         | 陳列架     | 17. rack                | 百科全書   | 25. encyclopedia      |
| 書名     | 9. title          | 影印機     | 18. photocopy machine   | 書架     | 26. shelf             |



①



③



⑦



⑤



②



④



⑥



⑨

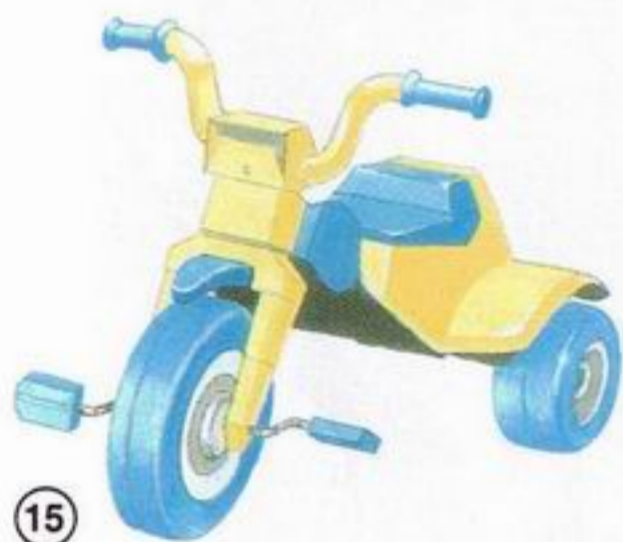

⑮



⑭



⑧



⑩



⑯



⑬



⑪



⑫

飛機  
熱氣球  
軟式飛船  
直升機  
飛機 (噴射機)

**Aircraft**

- 1. hot air balloon
- 2. blimp
- 3. helicopter
- 4. airplane (jet)

**冬季交通工具**

雪車  
掃雪車

**Vehicles of Winter**

- 8. snowmobile
- 9. snowplough

船  
游輪  
帆船  
遊艇

**Boats**

- 10. cruise ship
- 11. sailboat
- 12. motor boat

貨車  
拖車  
小貨車  
運油車

**Trucks**

- 5. tow truck
- 6. pickup truck
- 7. tank truck

單車、電單車  
電單車、摩托車

**Bikes**

綿羊仔  
三輪車  
單車

- 13. motorcycle
- 14. motor scooter
- 15. tricycle
- 16. bicycle





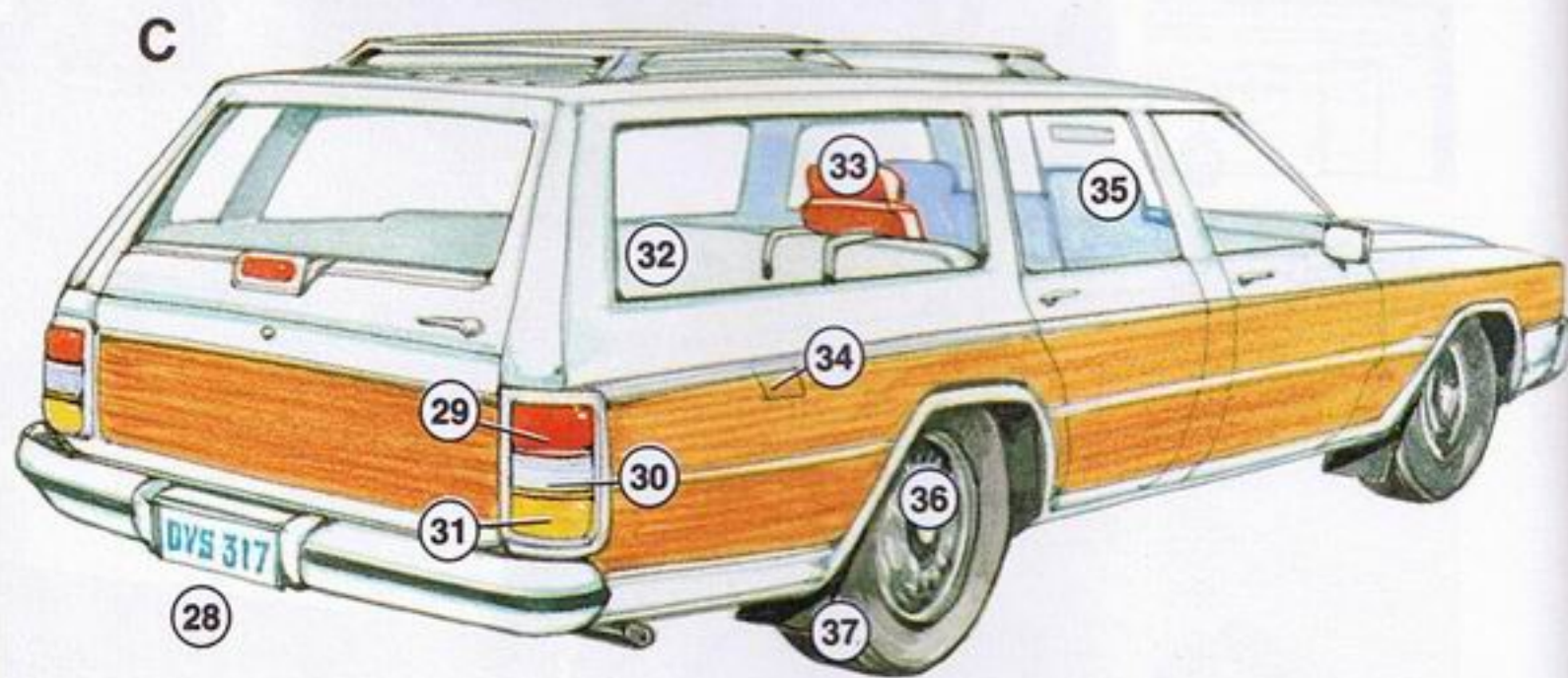
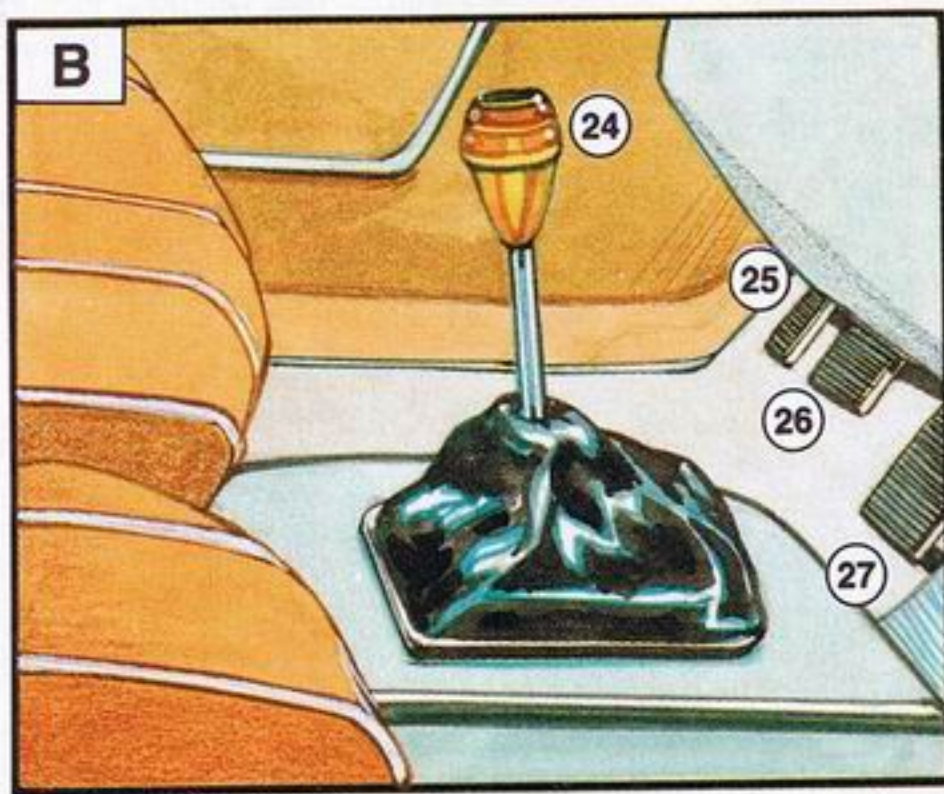
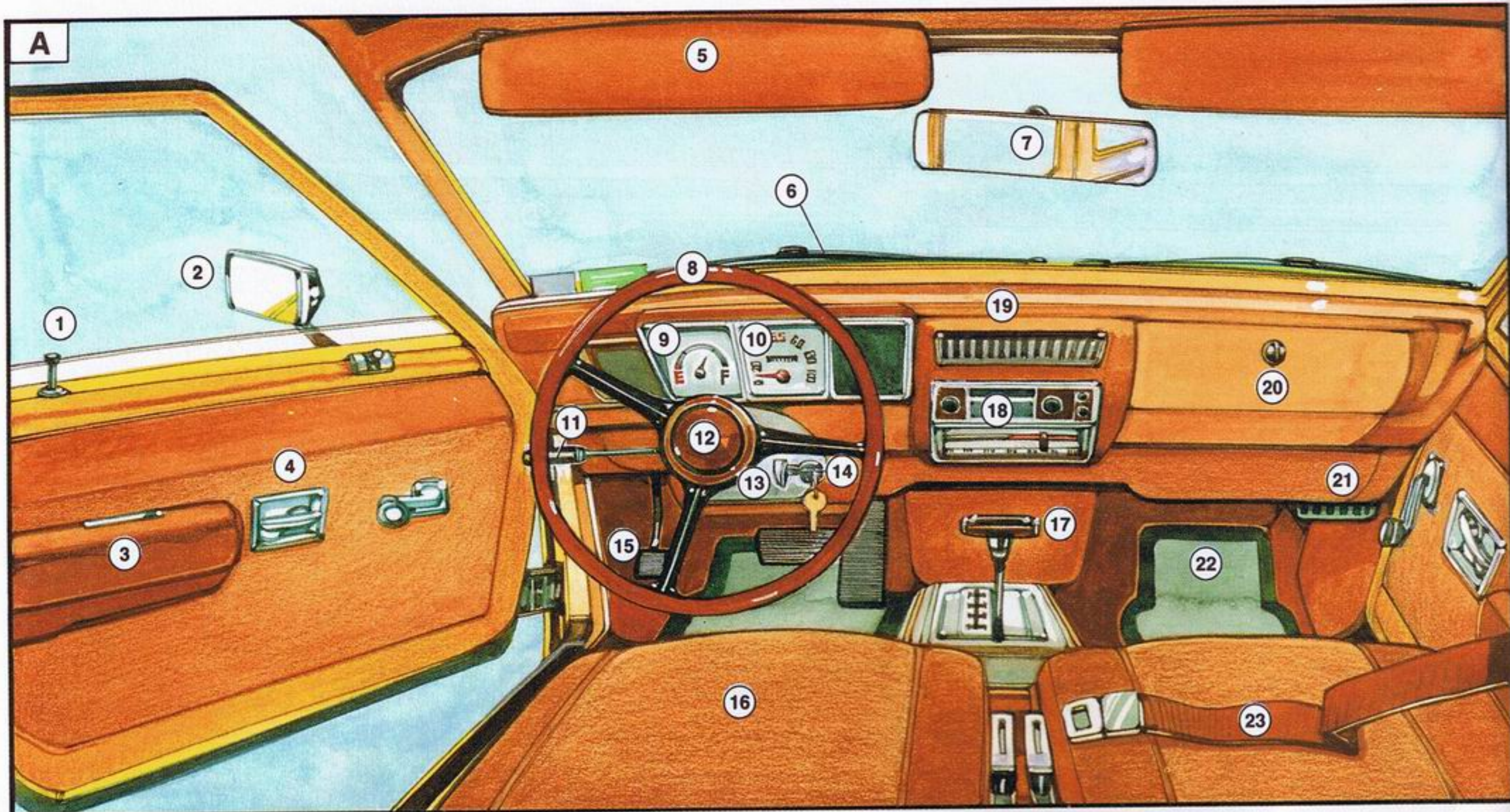

- 汽車內部  
門鎖  
側面倒後鏡  
手枕  
門柄  
遮陽光板  
水撥  
倒後鏡  
吐盤  
油錶  
咪錶  
方向燈操作桿  
喇叭  
圓柱  
發動裝置
- A. Car Interior**
1. door lock
  2. side mirror
  3. armrest
  4. door handle
  5. visor
  6. windshield wiper
  7. rearview mirror
  8. steering wheel
  9. gas gauge
  10. speedometer
  11. turn signal lever
  12. horn
  13. column
  14. ignition

- 緊急煞掣  
單人圓背摺椅  
換檔裝置  
收音機  
儀器板、錶板  
儲物箱  
排氣孔  
腳墊  
安全帶
- B. Manual Transmission**
15. emergency brake
  16. bucket seat
  17. gearshift
  18. radio
  19. dashboard
  20. glove compartment
  21. vent
  22. mat
  23. seat belt
  - 棍波
  24. stick shift
  - 波棍
  25. clutch
  - 離合器

- 煞掣  
油門
- C. Station Wagon**
26. brake
  27. accelerator
  - 旅行車
  28. license plate
  - 車牌
  - 煞掣燈
  29. brake light
  - 倒後燈
  30. backup light
  - 車尾燈
  31. taillight
  - 後座
  32. backseat
  - 兒童座位
  33. child's seat
  - 油箱
  34. gas tank
  - 頭枕
  35. headrest
  - 車吐蓋
  36. hubcap
  - 輪吐、車吐
  37. tire

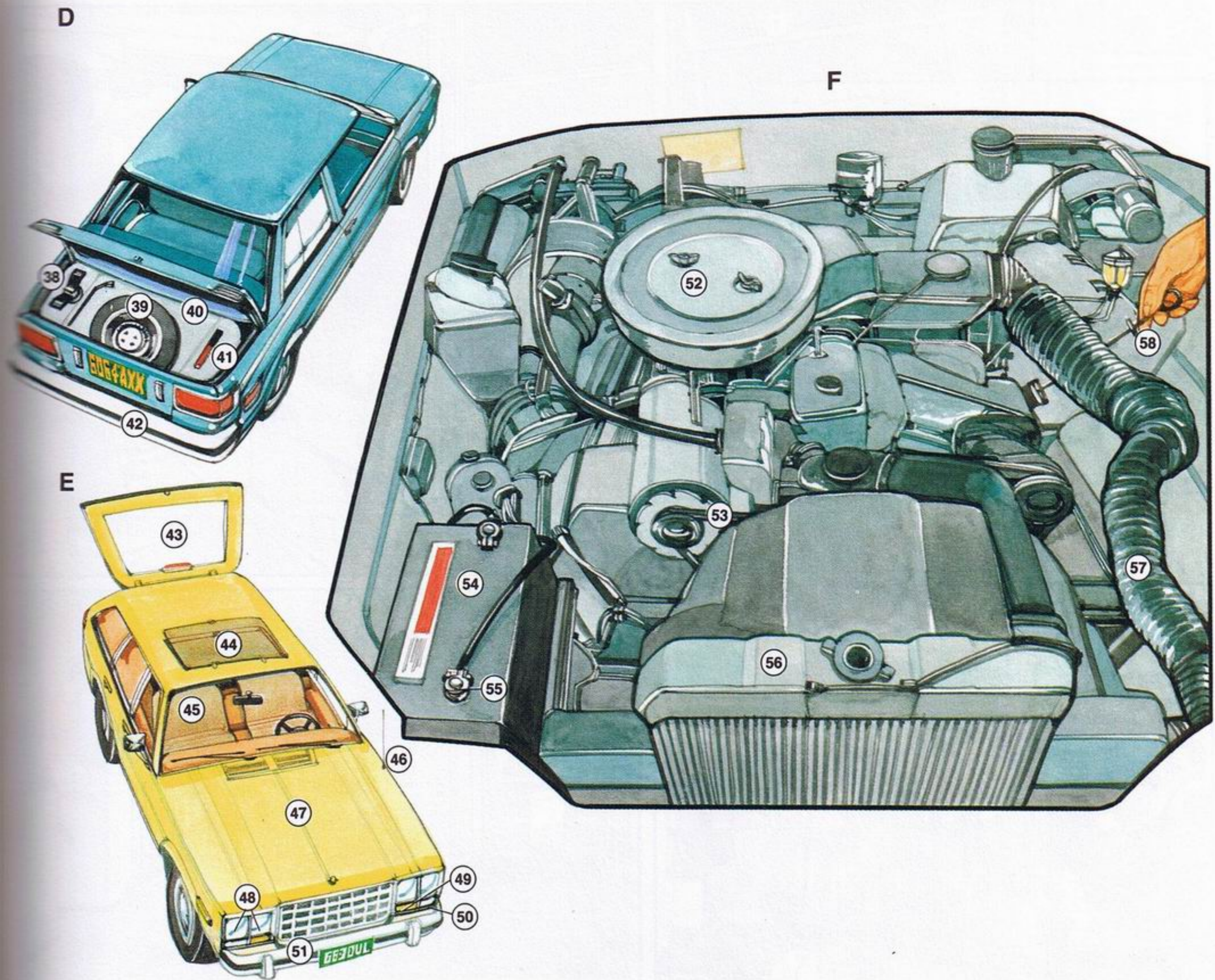

## (雙門) 轎車

## D. (Two-door) Sedan

- 千斤頂 38. jack  
 後備車呔 39. spare tire  
 車尾箱 40. trunk  
 反光板 41. flare  
 後面泵把 42. rear bumper

## 四門平背式

## E. Four-door Hatchback

- 平背式 43. hatchback  
 天窗 44. sunroof  
 擋風玻璃 45. windshield  
 天線 46. antenna  
 車頭蓋 47. hood  
 車頭燈 48. headlights  
 停車指示燈 49. parking lights  
 轉彎信號燈 50. turn signal (lights)  
 前面泵把 51. front bumper

## 引擎

## F. Engine

- 空氣過濾器 52. air filter  
 電風扇轉動帶 53. fan belt  
 電池 54. battery  
 電池接頭 55. terminal  
 散熱器 56. radiator  
 風管 57. hose  
 機油份量 58. dipstick  
 指示棍

公共交通運輸

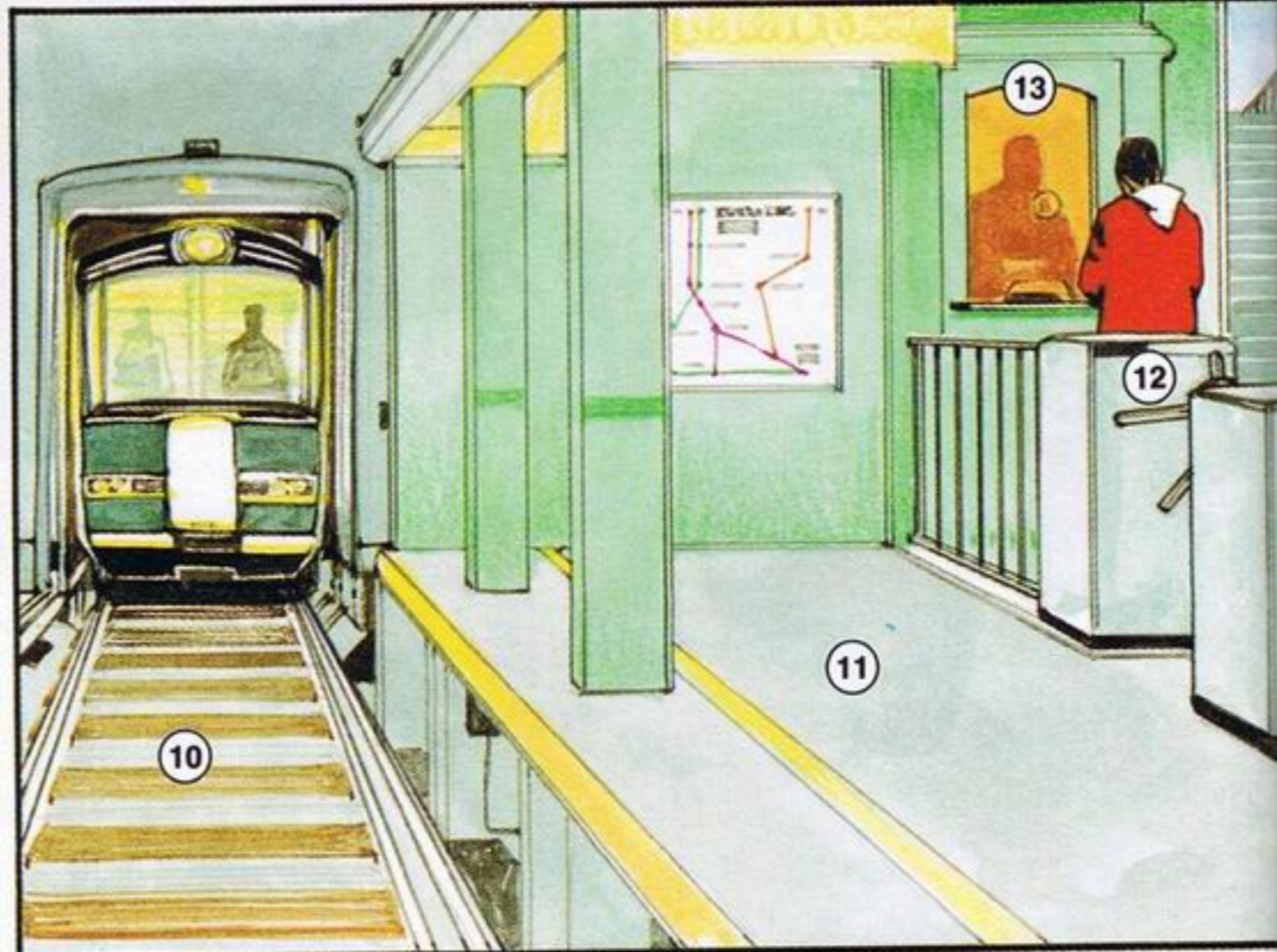
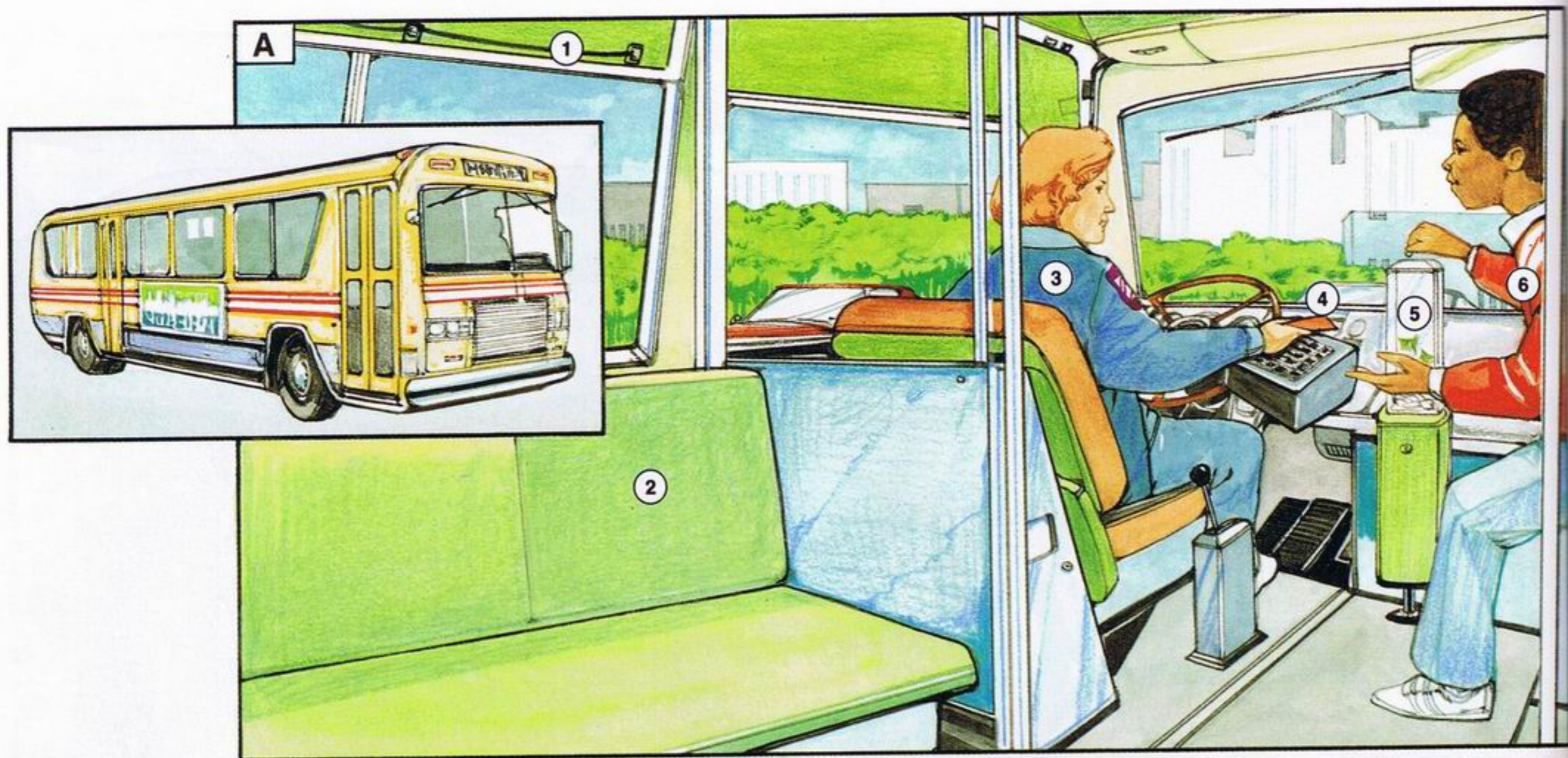

- 巴士 A. Bus  
 拉線 1. cord  
 座位 2. seat  
 巴士司機 3. bus driver  
 轉車車票 4. transfer  
 錢箱 5. fare box  
 乘客 6. rider

- 地下鐵、地下鐵路 B. Subway  
 收票員 7. guardsman/conductor  
 扶手柄/吊帶 8. bar/strap  
 車廂 9. car  
 路軌 10. truck  
 月臺 11. platform  
 入閘機 12. turnstile  
 售票處 13. token booth

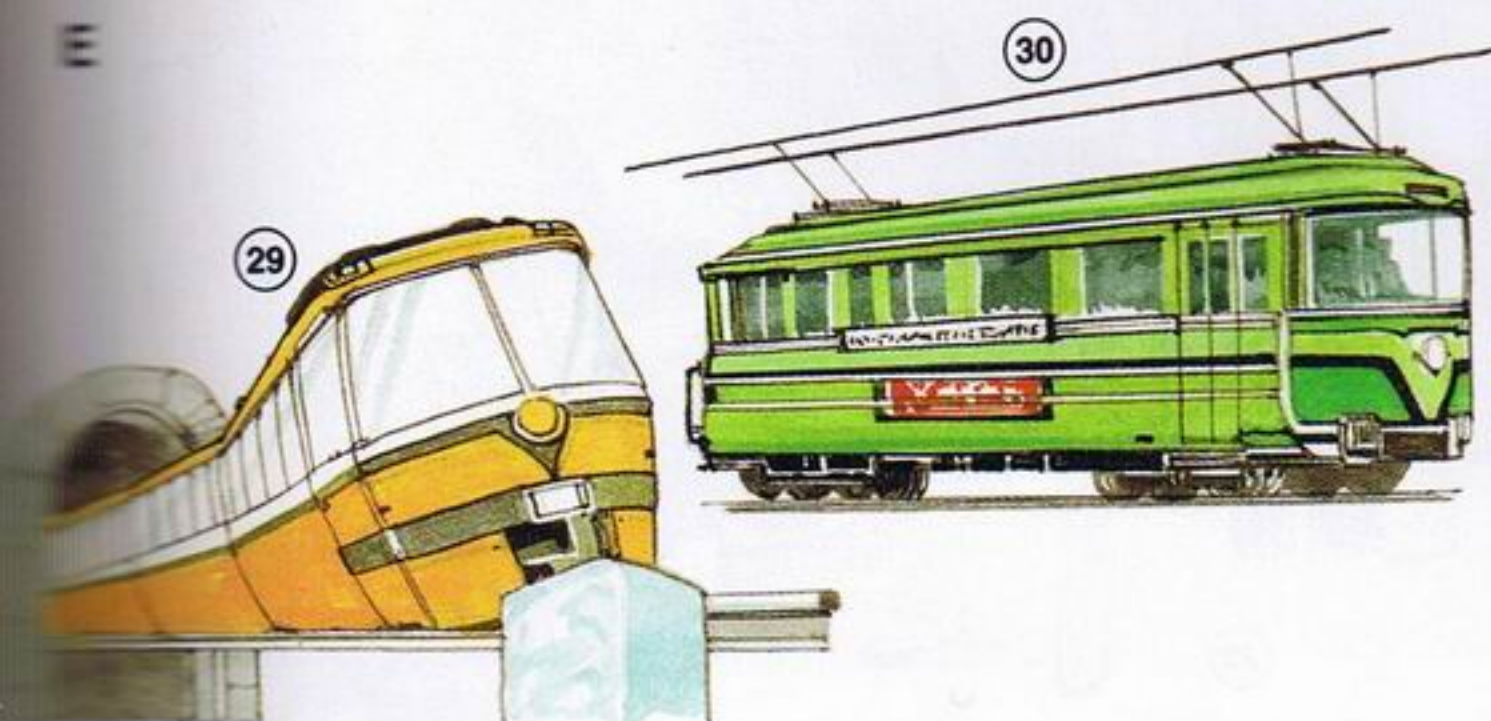
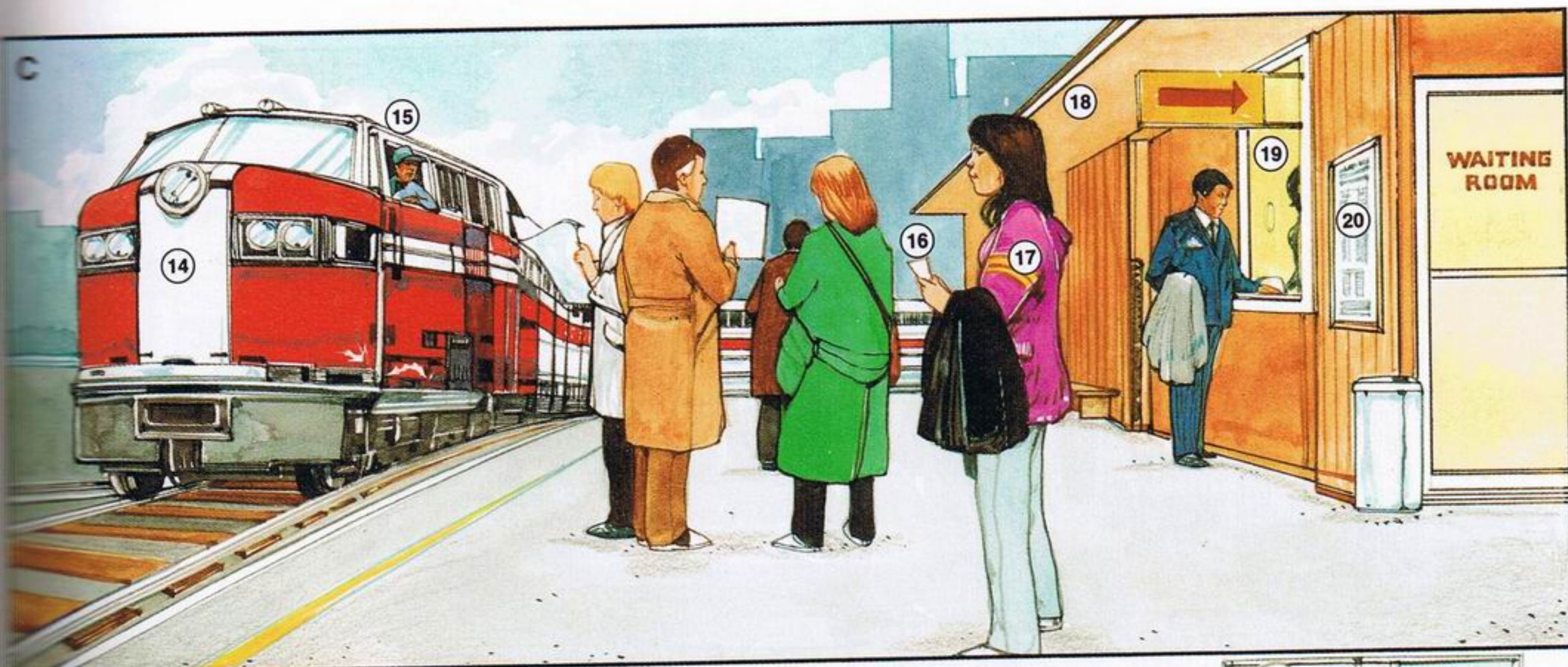

火車 C. Train  
 上落班火車 14. commuter train  
 司機 15. engineer  
 車票 16. ticket  
 上落班人士 17. commuter  
 車站 18. station  
 售票窗 19. ticket window  
 行車時間表 20. timetable

的士 D. Taxi  
 車費 21. fare  
 小費、貼士 22. tip  
 咪錶 23. meter  
 收據 24. receipt  
 乘客 25. passenger  
 的士司機 26. cab driver  
 的士 27. taxicab  
 的士站 28. taxi stand

其他交通形式、  
 其他運輸形式 E. Other Forms of Transportation  
 單軌火車 29. monorail  
 電車 30. streetcar  
 架空纜車 31. aerial tramway  
 纜車 32. cable car  
 馬車 33. horse-drawn carriage

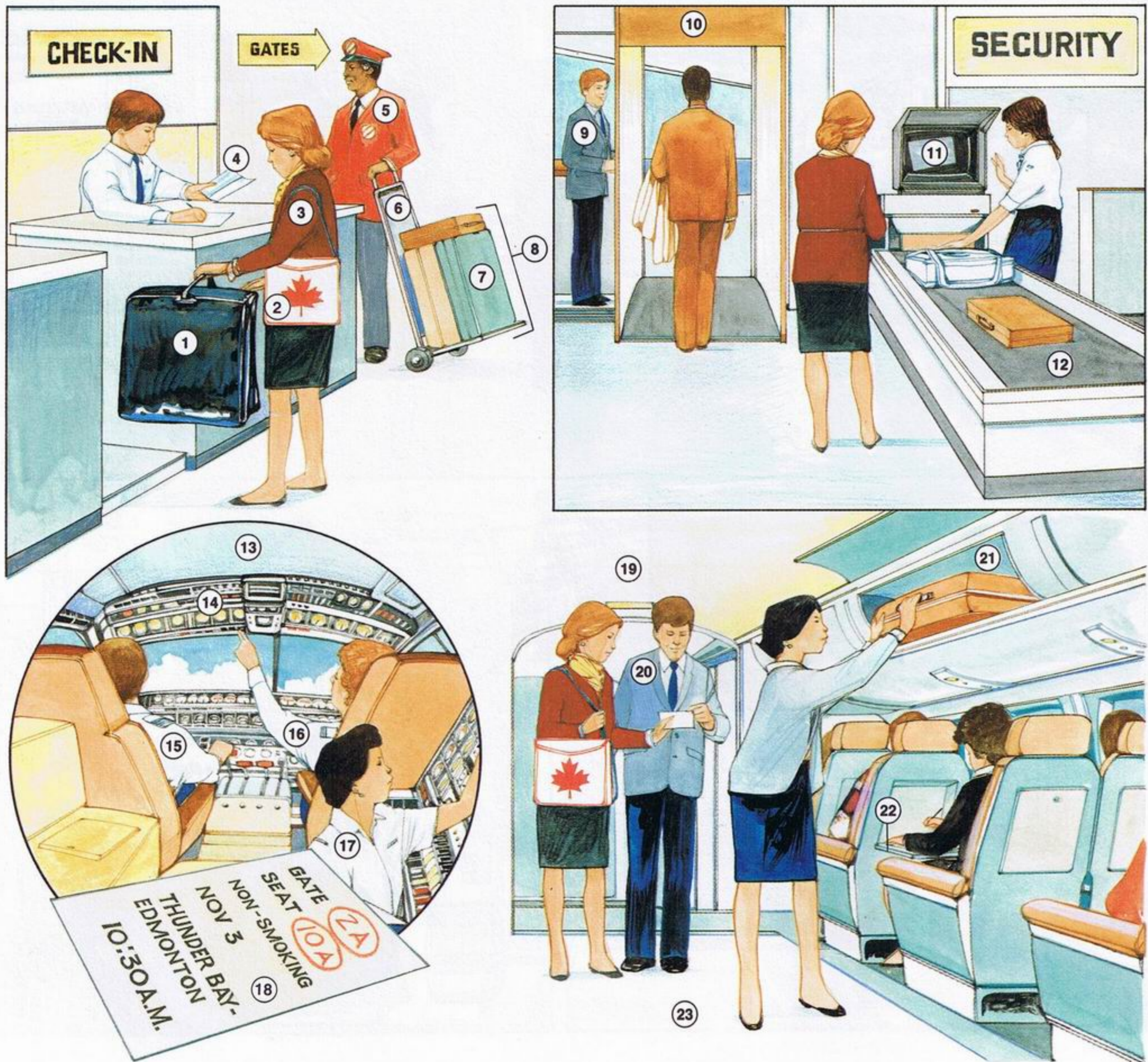

## 機場登記

衫袋、衣物袋  
手提袋、手提  
旅客  
飛機票  
行李搬運工人、  
機場搬行李工人

## A. Airport Check-In

1. garment bag  
2. carry-on bag  
3. traveller  
4. ticket  
5. porter/skycap

細輪手推車  
皮箱  
行李

6. dolly  
7. suitcase  
8. baggage

## 保安檢查

保安人員  
金屬探測器  
X光掃描機  
輸送帶

## Security

9. security guard  
10. metal detector  
11. X-ray screener  
12. conveyor belt

## 登機

駕駛艙  
儀器  
飛機師、機長

## Boarding

13. cockpit  
14. instruments  
15. pilot

副飛機師、  
副機長

空中機械師

登機證

機艙

空中服務員、空中

小姐、空中少爺

行李箱

摺枱

通道

16. copilot

17. flight engineer

18. boarding pass

19. cabin

20. flight attendant

21. luggage compartment

22. tray table

23. aisle



學校用詞 (動詞)

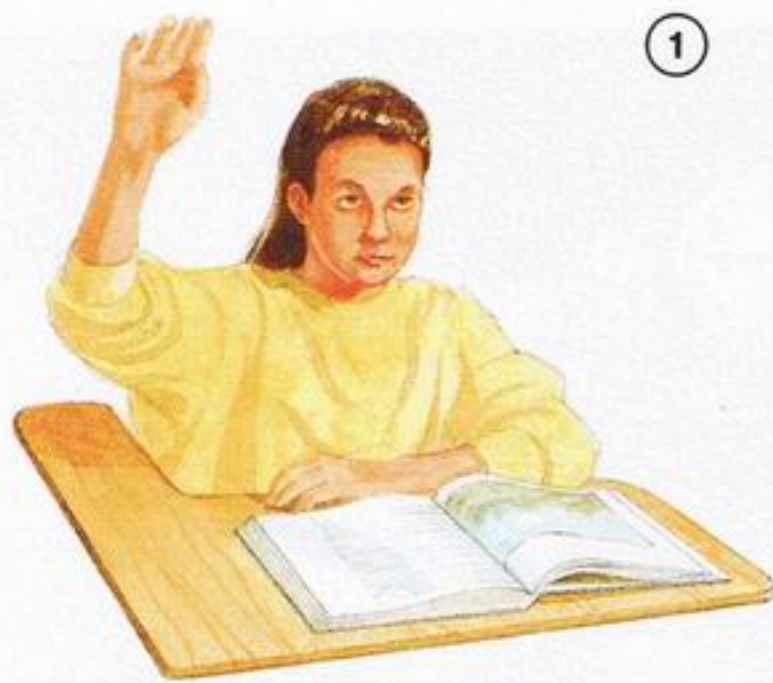

①



②



③



④



⑤



⑥



⑦



⑧



⑨



⑩



⑪



⑫



⑬



⑭

舉 (手) 1. raise (one's hand)

摸、碰 2. touch

擦 3. erase

讀 4. read

關 5. close

聽 6. listen

寫 7. write

行路 8. walk

撕 9. tear

打字 10. type

畫 11. draw

綁 12. tie

離開 13. leave

進入 14. enter



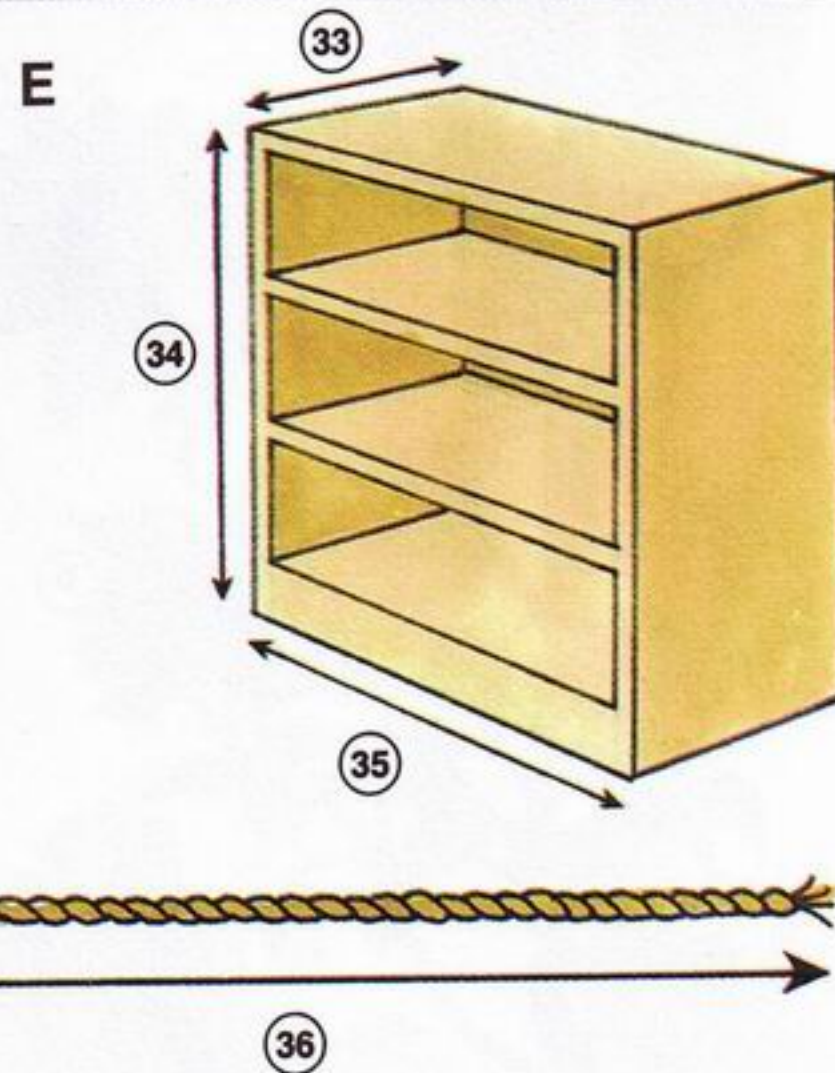
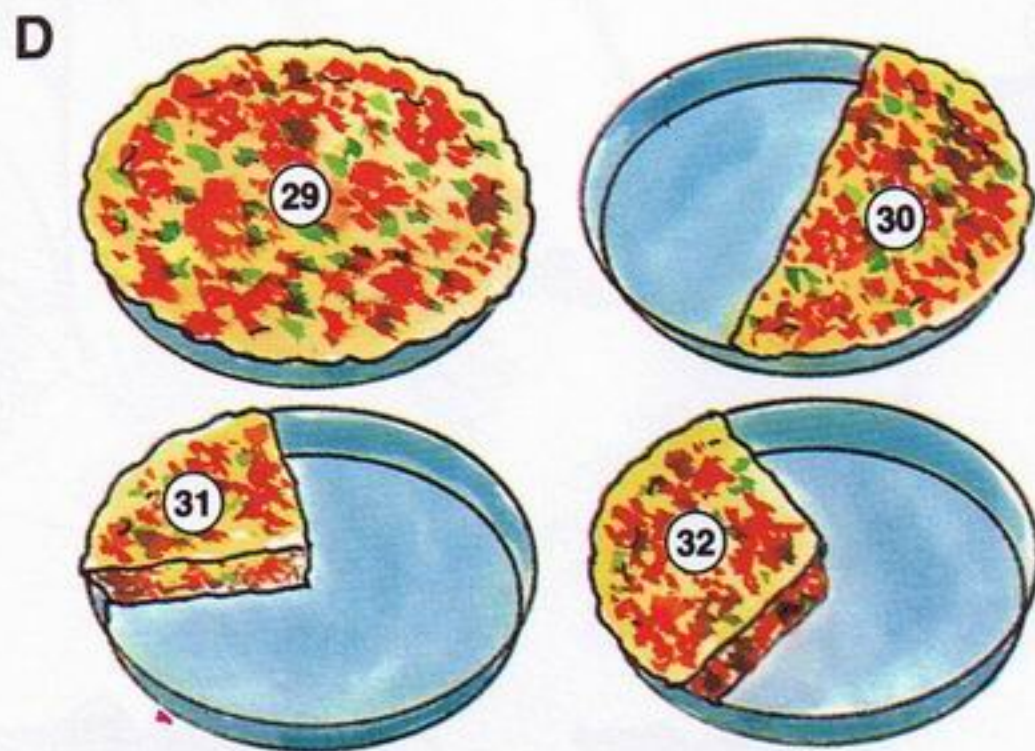
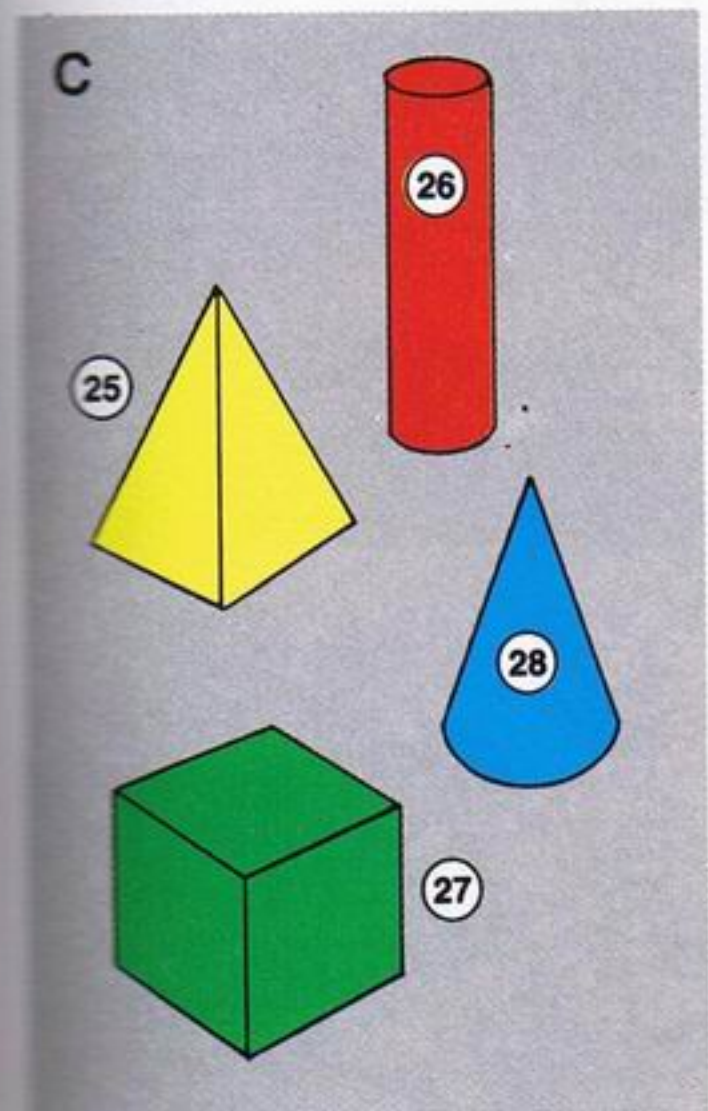
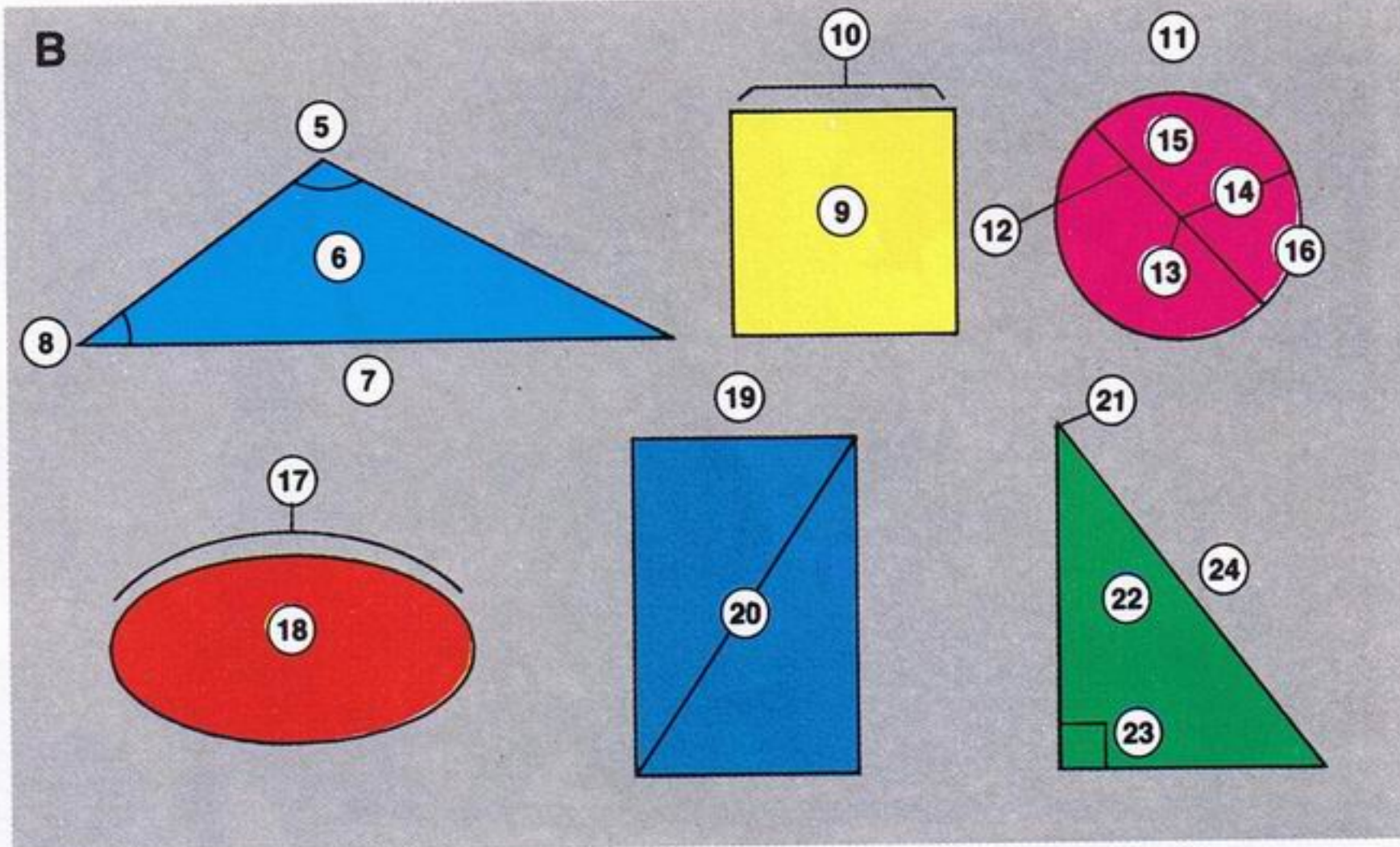
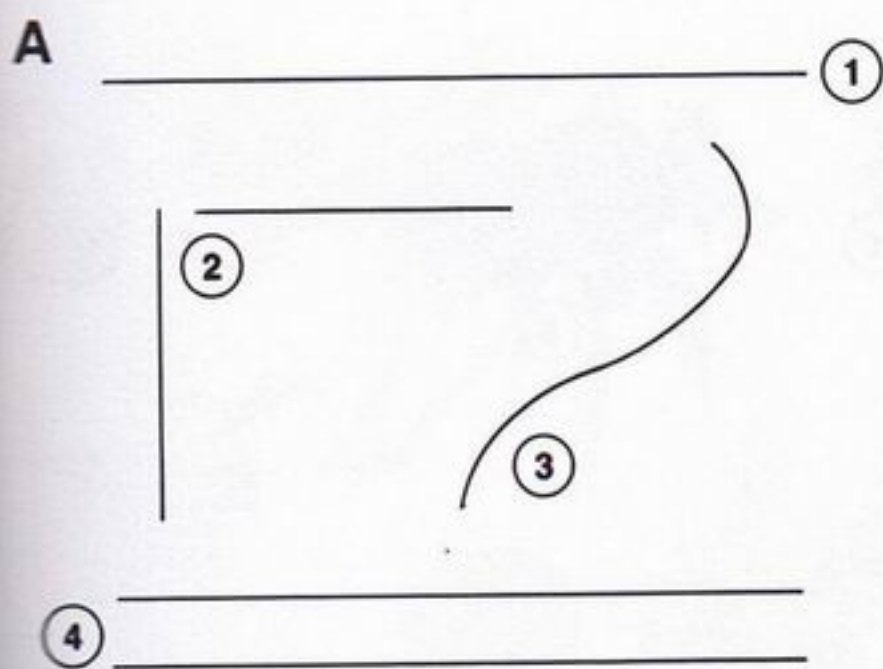

- 線條 **A. Lines**  
 直線 1. straight line  
 垂直線 2. perpendicular lines  
 曲線 3. curve  
 平行線 4. parallel lines
- 幾何圖形 **B. Geometrical Figures**  
 鈍角 5. obtuse angle  
 三角形 6. triangle  
 底邊 7. base  
 銳角 8. acute triangle  
 正方形 9. square  
 邊 10. side  
 圓形 11. circle  
 直徑 12. diameter

- 圓心 13. centre  
 半徑 14. radius  
 部分 15. section  
 弧 16. arc  
 圓周 17. circumference  
 橢圓形 18. oval  
 長方形 19. rectangle  
 對角線 20. diagonal  
 頂點 21. apex  
 直角三角形 22. right triangle  
 直角 23. right angle  
 斜邊 24. hypotenuse
- 立體圖形 **C. Solid Figures**  
 角錐 25. pyramid

- 圓柱 26. cylinder  
 立方體 27. cube  
 圓錐 28. cone
- 分數 **D. Fractions**  
 整數 29. whole  
 一半、二分之一 30. a half (1/2)  
 四分之一 31. a quarter (1/4)  
 三分之一 32. a third (1/3)
- 測量、量度 **E. Measurements**  
 深度 33. depth  
 高度 34. height  
 闊度 35. width  
 長度 36. length

植物及樹木



花 Flowers

- 1. tulip
- a. stem
- 2. pansy
- 3. lily
- 4. (chrysanthemum)
- 5. daisy
- 6. marigold
- 7. petunia
- 8. daffodil
- a. bulb
- 9. crocus
- 10. hyacinth

- 11. iris
- 12. orchid
- 13. zinnia
- 14. gardenia
- 15. poinsettia
- 16. violet
- 毛茛、金鳳花 17. buttercup
- 18. rose
- a. bud
- b. petal
- c. thorn
- 19. sunflower

草和穀類 Grasses and Grains

- 20. sugarcane
- 21. rice
- 22. wheat
- 23. oats
- 24. corn



樹木 **Trees**

- 紅木 25. redwood
- 棕櫚 26. palm
- 由加利樹 27. eucalyptus
- 山茱萸 28. dogwood
- 木蘭 29. magnolia
- 白楊 30. poplar
- 楊柳 31. willow
- 樺樹 32. birch
- 橡樹 33. oak
- 幼枝 a. twig
- 橡實 b. acorn

- 松 34. pine
- 針 a. needle
- 果實 b. cone
- 樹 35. tree
- 樹枝 a. branch
- 樹幹 b. trunk
- 樹皮 c. bark
- 樹根 d. root
- 榆樹 36. elm
- 葉 a. leaf
- 冬青樹 37. holly
- 楓樹 38. maple

其他植物 **Other Plants**

- 室內植物 39. house plants
- 仙人掌 40. cactus
- 灌木 41. bushes
- 蔓藤 42. vine

有毒植物 **Poisonous Plants**

- 毒橡 43. poison oak
- 野漆樹 44. poison sumac
- 毒藤 45. poison ivy



蝸牛 1. snail  
 殼 a. shell  
 觸角 b. antenna  
 蝾 2. oyster  
 青口 3. mussel  
 蛞蝓 4. slug

魷魚 5. squid  
 章魚、八爪魚 6. octopus  
 海星 7. starfish  
 蝦 8. shrimp  
 蟹 9. crab  
 帶子 10. scallop

蚯蚓 11. worm  
 水母、白炸 12. jellyfish  
 觸鬚 a. tentacle  
 龍蝦 13. lobster  
 鉗 a. claw

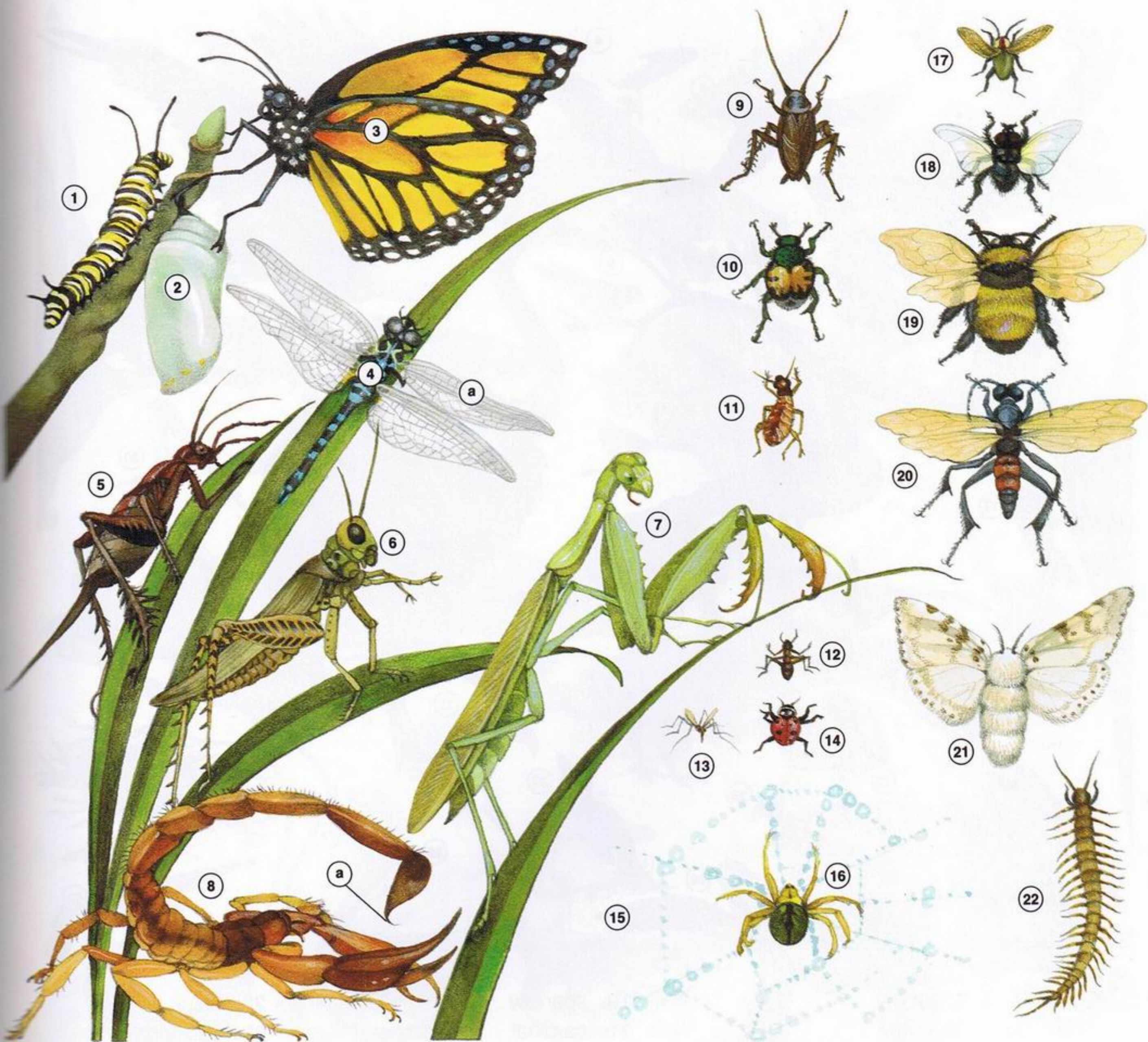

- 毛蟲 1. caterpillar
- 繭 2. cocoon
- 蝴蝶 3. butterfly
- 蜻蜓 4. dragonfly
- 翅膀、翼 a. wing
- 蟋蟀 5. cricket
- 草蜢、蚱蜢 6. grasshopper
- 螳螂 7. mantis

- 蝎子 8. scorpion
- 刺 a. sting
- 甲由 9. cockroach
- 甲蟲 10. beetle
- 白蟻 11. termite
- 螞蟻、蟻 12. ant
- 蚊 13. mosquito
- 瓢蟲 14. ladybug

- 網 15. web
- 蜘蛛 16. spider
- 螢火蟲 17. firefly
- 蒼蠅、烏蠅 18. fly
- 蜜蜂 19. bee
- 黃蜂 20. wasp
- 飛蛾 21. moth
- 蜈蚣 22. centipede

## 雀鳥、鳥類



- 白鴿 1. pigeon  
 翅膀、翼 a. wing  
 蜂鳥 2. hummingbird  
 烏鴉 3. crow  
 嘴 a. beak  
 海鷗 4. sea gull  
 鷹 5. eagle  
 貓頭鷹 6. owl  
 雕 7. hawk  
 羽毛 a. feather  
 藍檜鳥 8. blue jay  
 知更鳥 9. robin

- 麻雀 10. sparrow  
 緋鳥 11. cardinal  
 駝鳥 12. ostrich  
 蛋 13. egg  
 金絲雀 14. canary  
 嬌鳳 15. parakeet  
 鸚鵡 16. parrot  
 啄木鳥 17. woodpecker  
 孔雀 18. peacock  
 雉 19. pheasant  
 火雞 20. turkey  
 公雞 21. rooster

- 小雞、雞仔 22. chick  
 雞 23. chicken  
 塘鵝 24. pelican  
 嘴 a. bill  
 鴨 25. duck  
 鵝 26. goose  
 企鵝 27. penguin  
 天鵝 28. swan  
 火烈鳥 29. flamingo  
 白鶴 30. stork  
 巢 31. nest  
 長尾雞 32. roadrunner

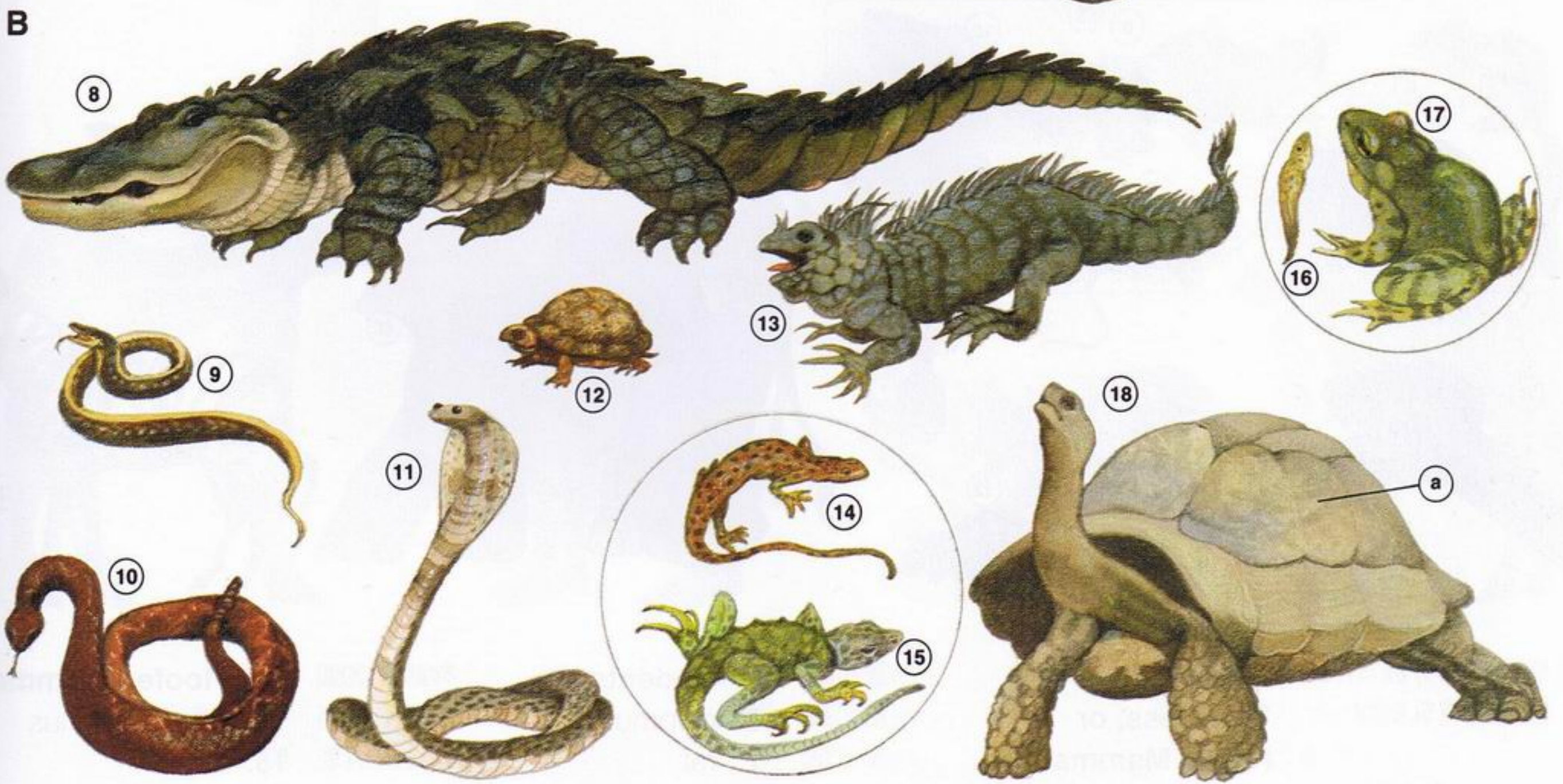
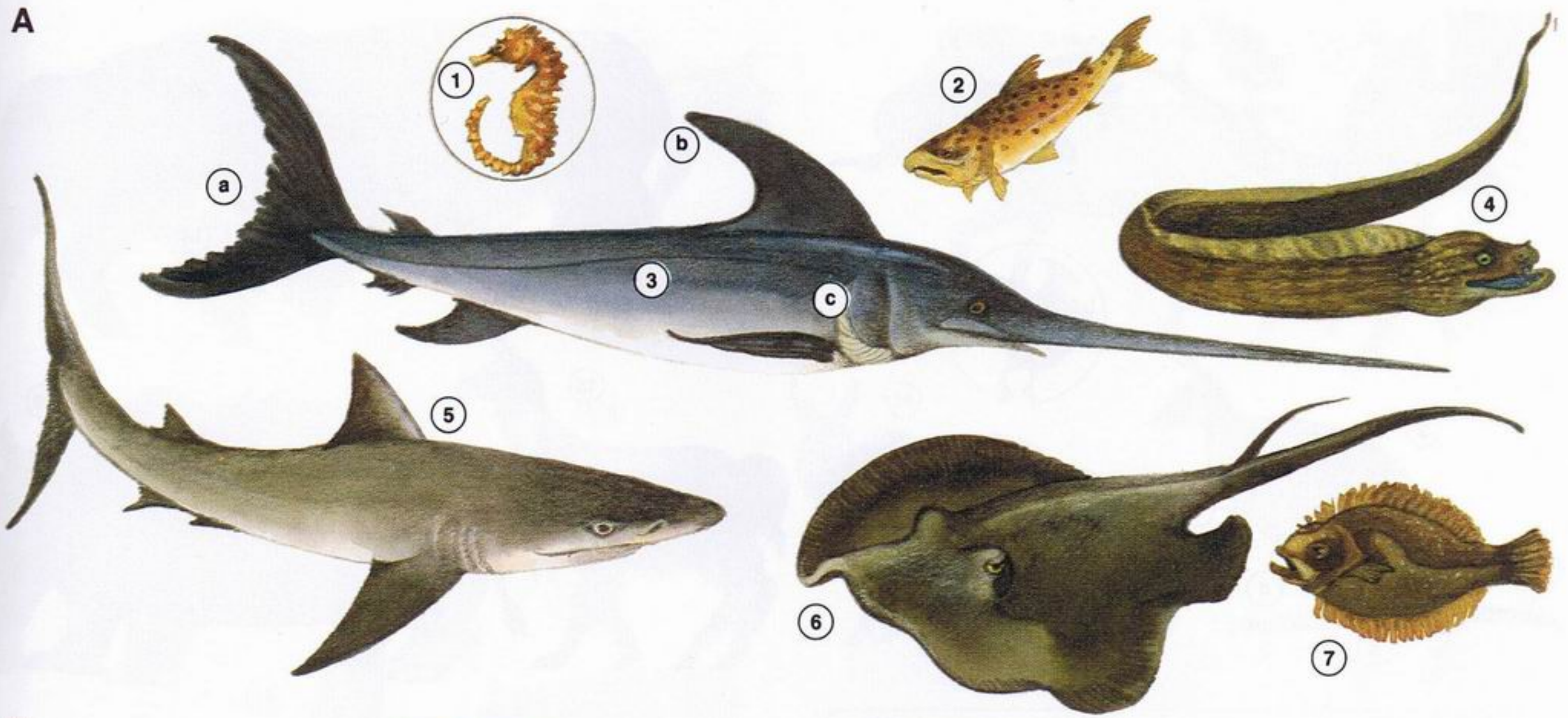

- 魚 A. Fish**  
 海馬 1. sea horse  
 鱒魚 2. trout  
 旗魚 3. swordfish  
 尾巴、尾 尾 a. tail  
 鰭 b. fin  
 鰓 c. gill  
 鰻魚 4. eel  
 鯊魚 5. shark

- 黃貂魚 6. stingray  
 比目魚 7. flounder  
**兩棲類、爬蟲類 B. Amphibians and Reptiles**  
 鱷魚 8. alligator  
 (黃紋) 蛇 9. (garter) snake  
 響尾蛇 10. rattlesnake  
 眼鏡蛇 11. cobra

- 烏龜 12. turtle  
 鬣蜥 13. iguana  
 火蜥蜴 14. salamander  
 蜥蜴 15. lizard  
 蝌蚪 16. tadpole  
 青蛙 17. frog  
 龜殼 18. tortoise  
 a. shell

哺乳類一

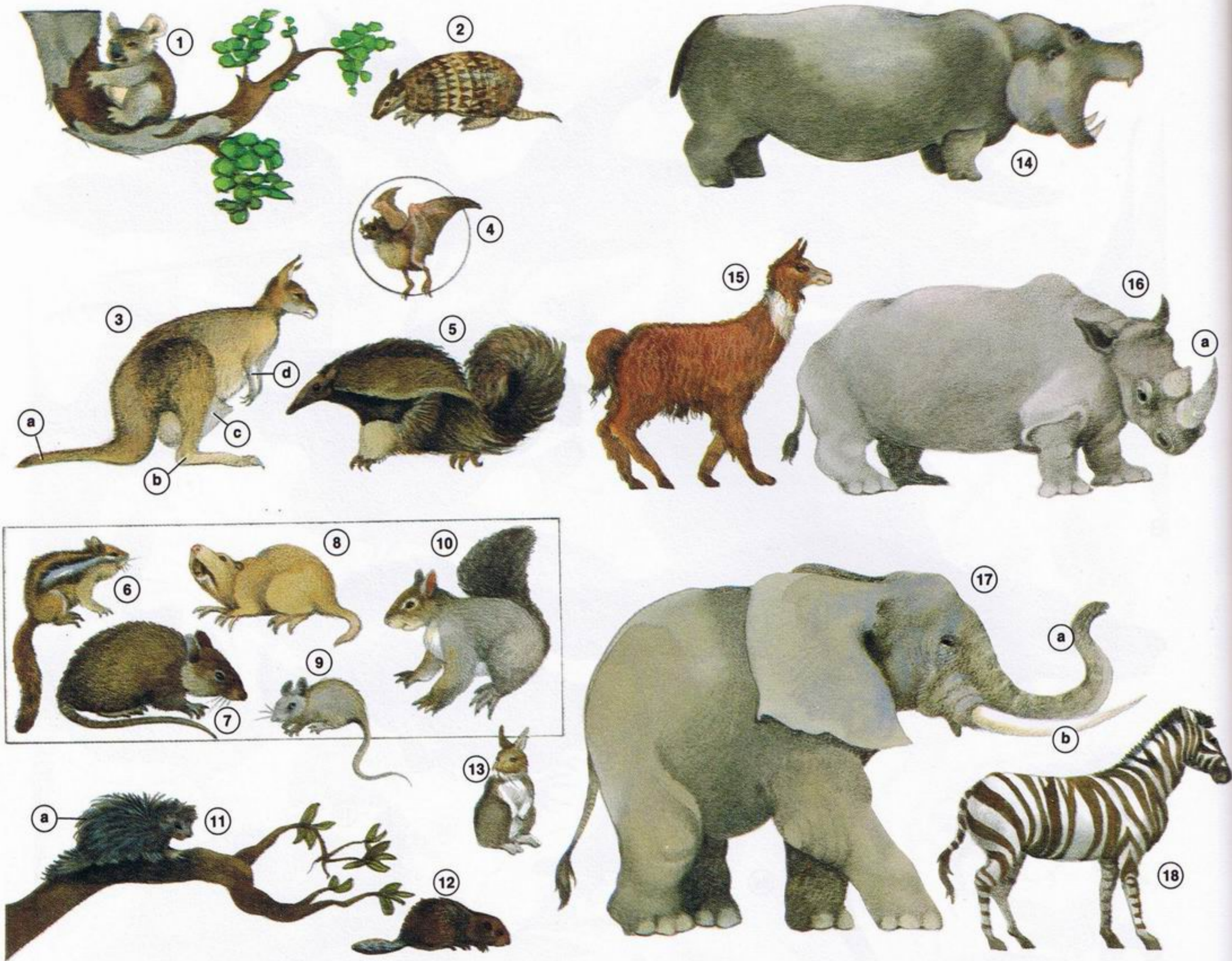

有袋、沒有牙齒或會飛的哺乳動物

無尾熊  
穿山甲  
袋鼠  
尾巴、尾  
後腳  
袋  
前腳  
蝙蝠  
食蟻獸

**Pouched, Toothless, or Flying Mammals**

1. koala
2. armadillo
3. kangaroo
- a. tail
- b. hind legs
- c. pouch
- d. forelegs
4. bat
5. anteater

齧齒類

花栗鼠  
大老鼠  
土撥鼠  
細老鼠、  
老鼠仔  
松鼠  
箭豬  
針  
海狸  
白兔、兔仔

**Rodents**

6. chipmunk
7. rat
8. gopher
9. mouse
10. squirrel
11. porcupine
- a. quill
12. beaver
13. rabbit

有蹄哺乳類

河馬  
美洲駝  
犀牛  
角  
大象  
象鼻  
象牙  
斑馬

**Hoofed Mammals**

14. hippopotamus
15. llama
16. rhinoceros
- a. horn
17. elephant
- a. trunk
- b. tusk
18. zebra



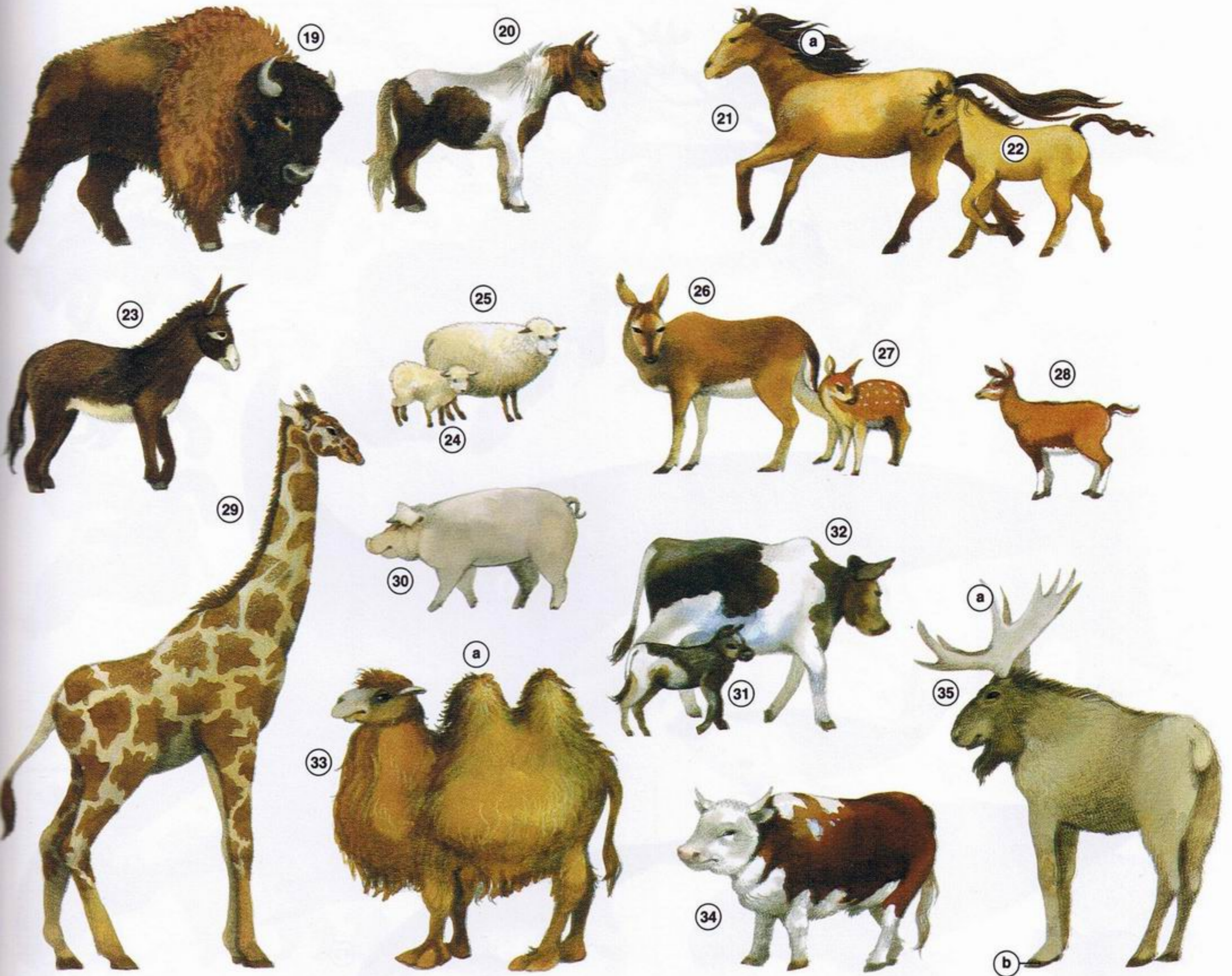

野牛 19. bison  
 細馬、馬仔 20. pony  
 馬 21. horse  
 鬃毛 a. mane  
 駒 22. foal  
 驢、驢仔 23. donkey  
 羔羊 24. lamb

綿羊 25. sheep  
 鹿 26. deer  
 小鹿 27. fawn  
 山羊 28. goat  
 長頸鹿 29. giraffe  
 豬 30. hog  
 牛仔 31. calf

牛 32. cow  
 駱駝 33. camel  
 峰 a. hump  
 公牛 34. bull  
 美洲鹿 35. moose  
 角 a. antler  
 蹄 b. hoof



- 豹 1. leopard
- 老虎 2. tiger
- 爪 a. claw
- 獅子 3. lion
- 貓 4. cat
- 貓仔 5. kitten
- 狐狸 6. fox
- 浣熊 7. raccoon
- 臭鼬鼠 8. skunk

- |        |                        |
|--------|------------------------|
| 水中哺乳類  | <b>Aquatic Mammals</b> |
| 鯨魚 9.  | whale                  |
| 水獺 10. | otter                  |
| 海象 11. | walrus                 |
| 海豹 12. | seal                   |
| 蹼 a.   | flipper                |
| 海豚 13. | dolphin                |



- 靈長類 Primates**  
 猴子 14. monkey  
 長臂猿 15. gibbon  
 黑猩猩 16. chimpanzee  
 大猩猩 17. gorilla  
 猩猩 18. orangutan  
 狒狒 19. baboon

- 熊 Bears**  
 熊貓 20. panda  
 黑熊 21. black bear  
 北極熊 22. polar bear  
 灰熊 23. grizzly bear

- 犬 Dogs**  
 長毛狗 24. spaniel  
 獒 25. terrier  
 獵狗 26. retriever  
 小狗 27. puppy  
 牧羊狗 28. shepherd

- 豺狼 29. wolf  
 爪 a. paw  
 土狼 30. hyena

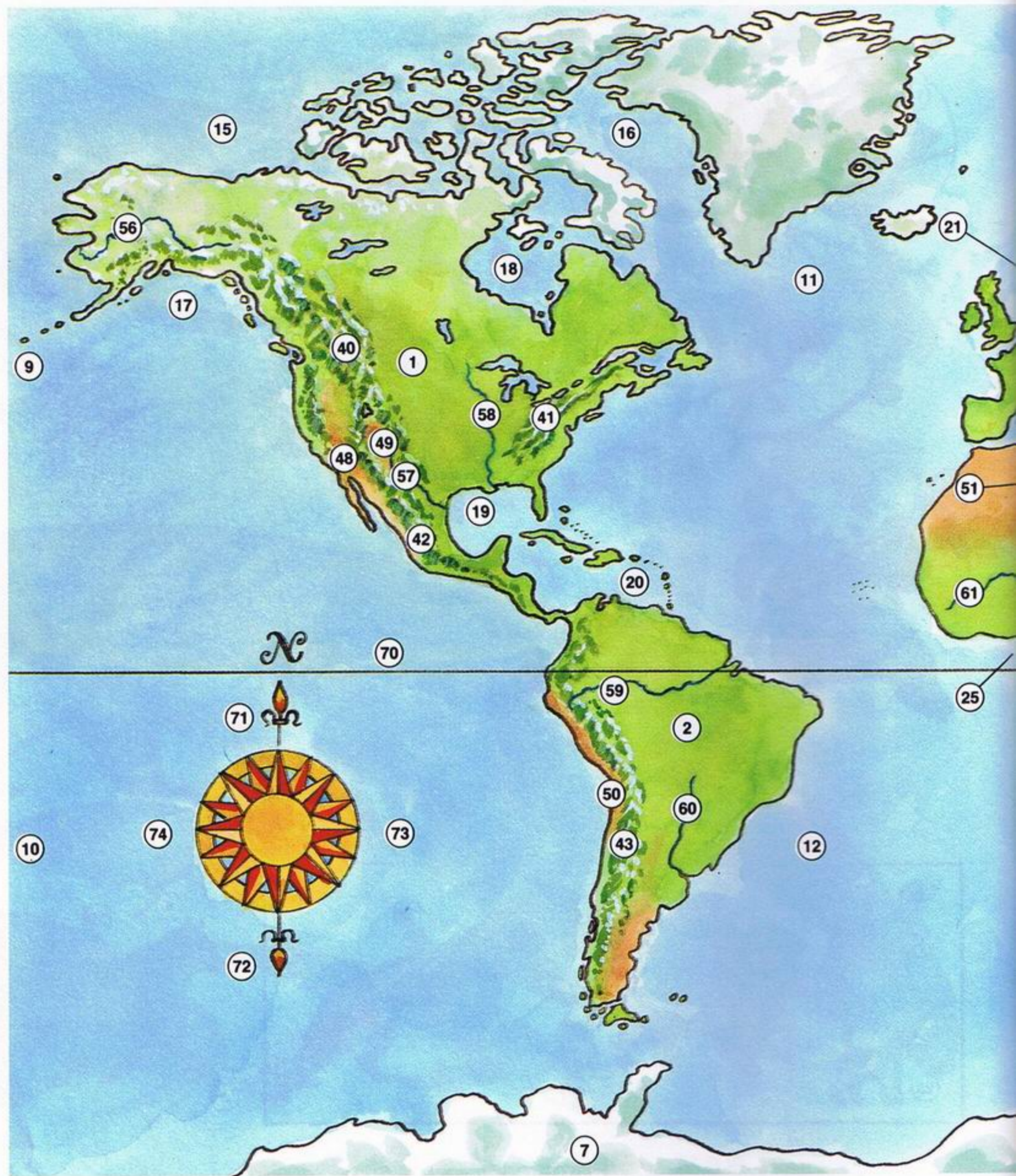

- |      |                    |         |                         |       |                     |
|------|--------------------|---------|-------------------------|-------|---------------------|
| 大洲   | <b>Continents</b>  | 印度洋     | 13. Indian              | 幾內亞灣  | 25. Gulf of Guinea  |
| 北美洲  | 1. North America   | 南極洋、南冰洋 | 14. Antarctic           | 黑海    | 26. Black Sea       |
| 南美洲  | 2. South America   |         |                         | 裏海    | 27. Caspian Sea     |
| 歐洲   | 3. Europe          | 海、海灣和   | <b>Seas, Gulfs, and</b> | 波斯灣   | 28. Persian Gulf    |
| 非洲   | 4. Africa          | 小海灣     | <b>Bays</b>             | 紅海    | 29. Red Sea         |
| 亞洲   | 5. Asia            | 波福海     | 15. Beaufort Sea        | 阿拉伯海  | 30. Arabian Sea     |
| 澳洲   | 6. Australia       | 巴芬灣     | 16. Baffin Bay          | 喀拉海   | 31. Kara Sea        |
| 南極洲  | 7. Antarctica      | 阿拉斯加灣   | 17. Gulf of Alaska      | 孟加拉灣  | 32. Bay of Bengal   |
|      |                    | 哈德遜灣    | 18. Hudson Bay          | 拉普提夫海 | 33. Laptev Sea      |
|      |                    | 墨西哥灣    | 19. Gulf of Mexico      | 白令海   | 34. Bering Sea      |
|      |                    | 加勒比海    | 20. Caribbean Sea       | 鄂霍次克海 | 35. Sea of Okhotsk  |
| 海洋   | <b>Oceans</b>      | 北海      | 21. North Sea           | 日本海   | 36. Sea of Japan    |
| 北冰洋  | 8. Arctic          | 波羅的海    | 22. Baltic Sea          | 黃海    | 37. Yellow Sea      |
| 北太平洋 | 9. North Pacific   | 巴倫支海    | 23. Barents Sea         | 東中國海  | 38. East China Sea  |
| 南太平洋 | 10. South Pacific  | 地中海     | 24. Mediterranean Sea   | 南中國海  | 39. South China Sea |
| 北大西洋 | 11. North Atlantic |         |                         |       |                     |
| 南大西洋 | 12. South Atlantic |         |                         |       |                     |

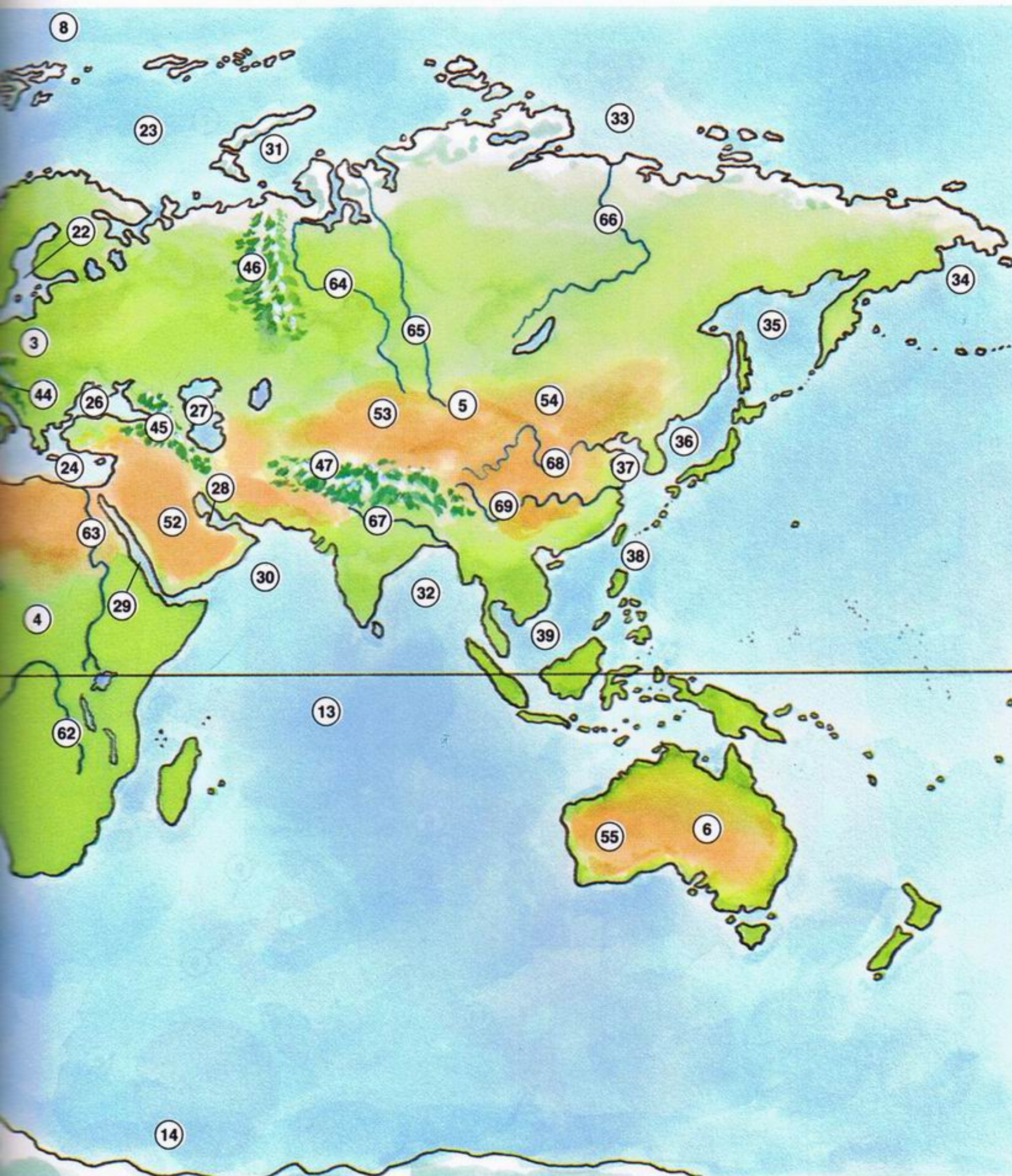

- |         |                           |               |                   |        |             |
|---------|---------------------------|---------------|-------------------|--------|-------------|
| 山脈      | <b>Mountain Ranges</b>    | 撒哈拉沙漠         | 51. Sahara        | 剛果河    | 62. Congo   |
| 落磯山脈    | 40. Rocky Mountains       | 拉伯加利大沙漠       | 52. Rub' al Khali | 尼羅河    | 63. Nile    |
| 阿帕拉契山脈  | 41. Appalachian Mountains | 大戈壁沙漠、塔克拉瑪干沙漠 | 53. Takla Makan   | 鄂畢河    | 64. Ob      |
| 塞拉馬德雷山脈 | 42. Sierra Madre          | 戈壁沙漠          | 54. Gobi          | 葉尼塞河   | 65. Yenisey |
| 安地斯山脈   | 43. Andes                 | 大沙沙漠          | 55. Great Sandy   | 勒拿河    | 66. Lena    |
| 阿爾卑斯山脈  | 44. Alps                  | 河流            | <b>Rivers</b>     | 恆河     | 67. Ganges  |
| 高加索山脈   | 45. Caucasus              | 育康河           | 56. Yukon         | 黃河     | 68. Huang   |
| 烏拉山脈    | 46. Urals                 | 里奧格蘭河         | 57. Rio Grande    | 長江、揚子江 | 69. Yangtze |
| 喜馬拉雅山脈  | 47. Himalayas             | 密西西比河         | 58. Mississippi   | 赤道     | 70. equator |
| 沙漠      | <b>Deserts</b>            | 亞馬遜河          | 59. Amazon        | 北      | 71. north   |
| 摩哈維沙漠   | 48. Mojave                | 巴拉那河          | 60. Paraná        | 南      | 72. south   |
| 多色沙漠    | 49. Painted               | 尼日河           | 61. Niger         | 東      | 73. east    |
| 亞他加馬沙漠  | 50. Atacama               |               |                   | 西      | 74. west    |

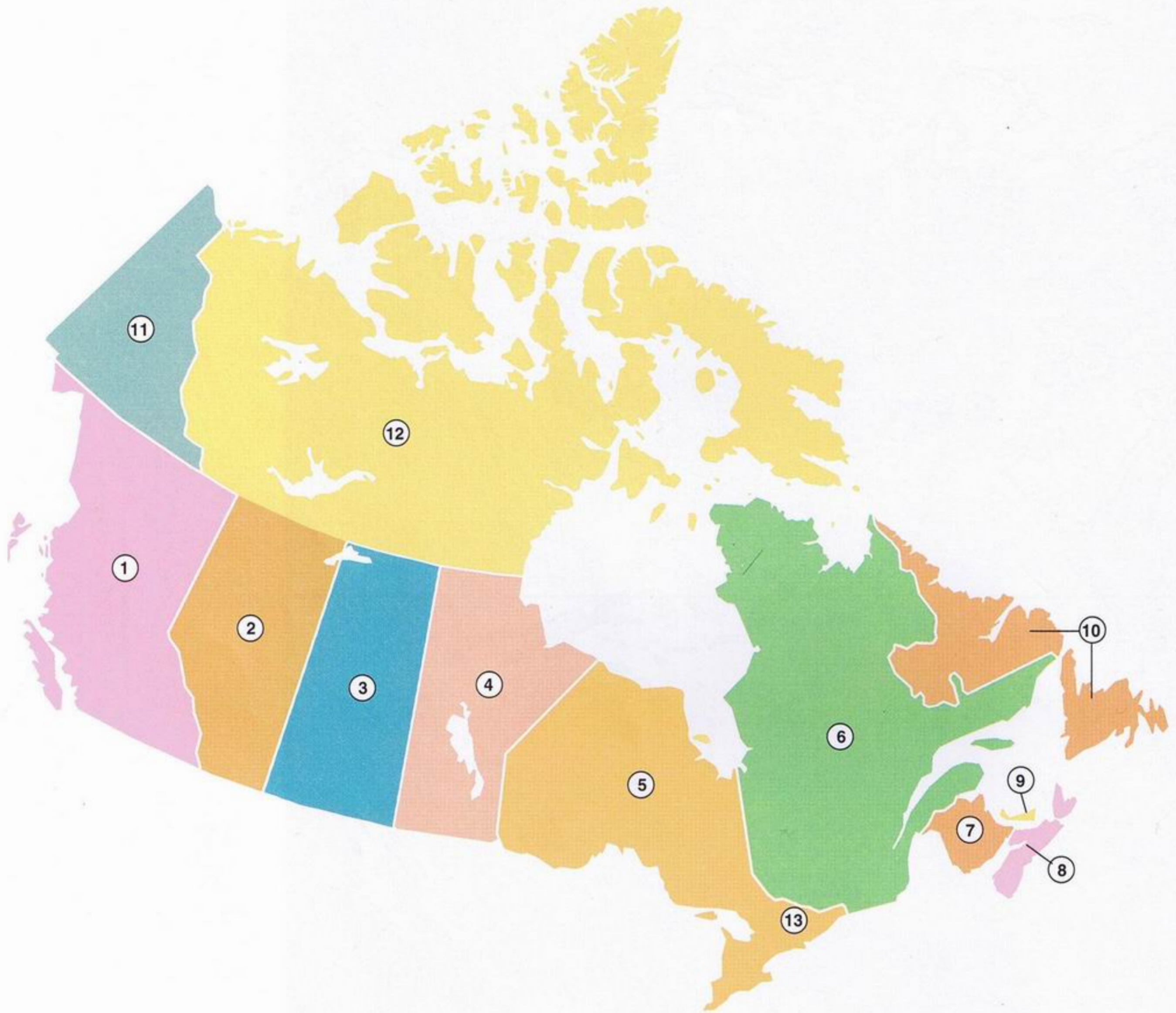

省、省份

**Provinces**

- 卑詩 1. British Columbia
- 亞伯達 2. Alberta
- 沙省 3. Saskatchewan
- 曼尼托巴 4. Manitoba
- 安大略 5. Ontario

魁北克

- 6. Quebec

紐賓士域

- 7. New Brunswick

魯華史高沙

- 8. Nova Scotia

愛德華島

- 9. Prince Edward Island

紐芬蘭和  
拉布拉多

- 10. Newfoundland and Labrador

領土

**Territories**

育康地區

- 11. Yukon Territory

西北領土

- 12. Northwest Territories

加拿大首府  
城市

**Capital City of  
Canada**

渥太華

- 13. Ottawa



國旗 1. flag  
 盾徽 2. coat of arms  
 海狸 3. beaver  
 楓葉 4. maple leaf  
 紙幣 5. bills  
 硬幣/碎銀 6. coins/change

兩元加幣 7. two dollar coin/toonie  
 一元加幣 8. loonie  
 兩毫半、兩角五分 9. quarter  
 一毫、一角 10. dime

五仙、五分 11. nickel  
 一仙、一分 12. penny/cent  
 信用咭、信用卡 13. credit card  
 支票 14. cheque

省份標記

Province  
省、省份

Flag  
旗幟

Shield  
盾徽

Flower  
省花

Alberta  
亞伯達



British Columbia  
卑詩



Manitoba  
曼尼托巴



New Brunswick  
紐賓士域



Newfoundland  
紐芬蘭

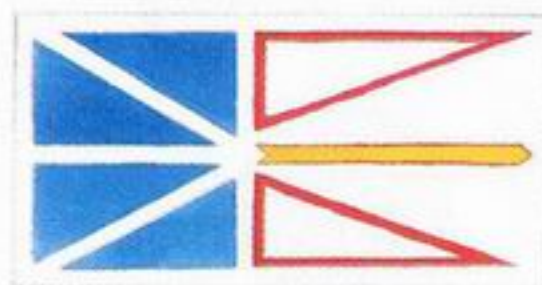

Northwest Territories  
西北領土



野玫瑰 1. wild rose  
山茱萸 2. pacific dogwood

番紅花 3. prairie crocus  
紫羅蘭 4. purple violet

豬籠草 5. pitcher plant  
仙女木 6. mountain avens



Province  
省、省份

Flag  
旗幟

Shield  
盾徽

Flower  
省花

Nova Scotia  
魯華史高沙



Ontario  
安大略

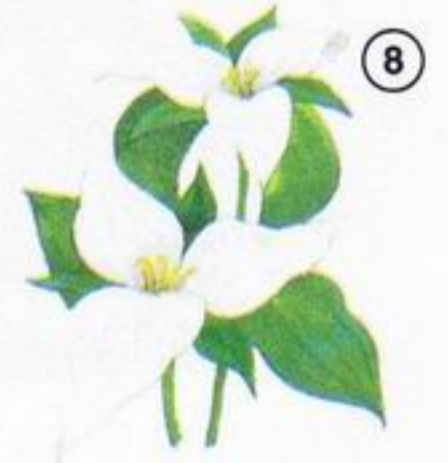

Prince Edward Island  
愛德華島



Quebec  
魁北克



Saskatchewan  
沙省



Yukon Territory  
育康地區



五月花 7. mayflower  
白延齡草 8. white trillium

杓蘭 9. lady's slipper  
白百合 10. white garden lily

紅百合 11. western red lily  
曼陀羅 12. fireweed

加拿大政府

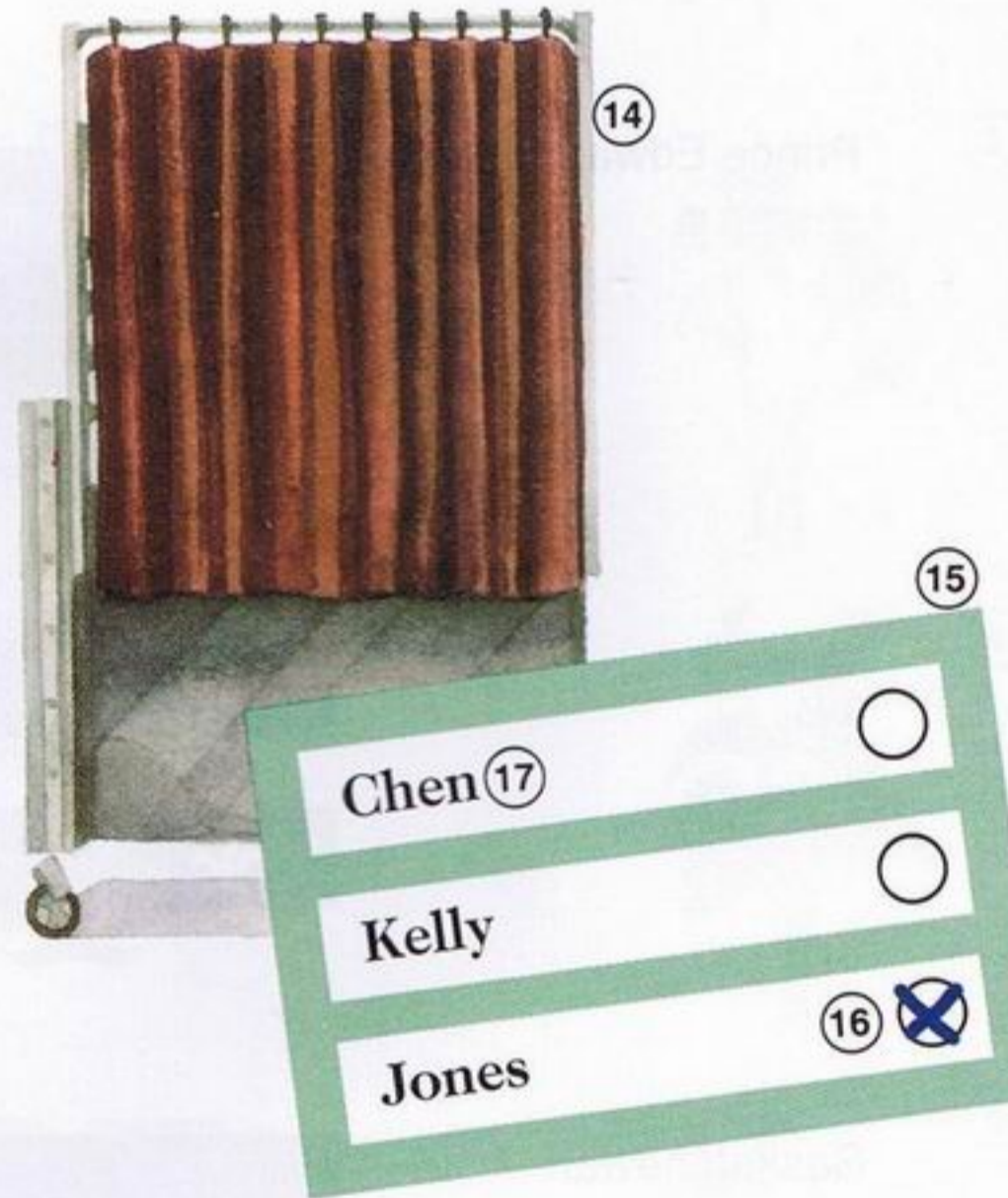
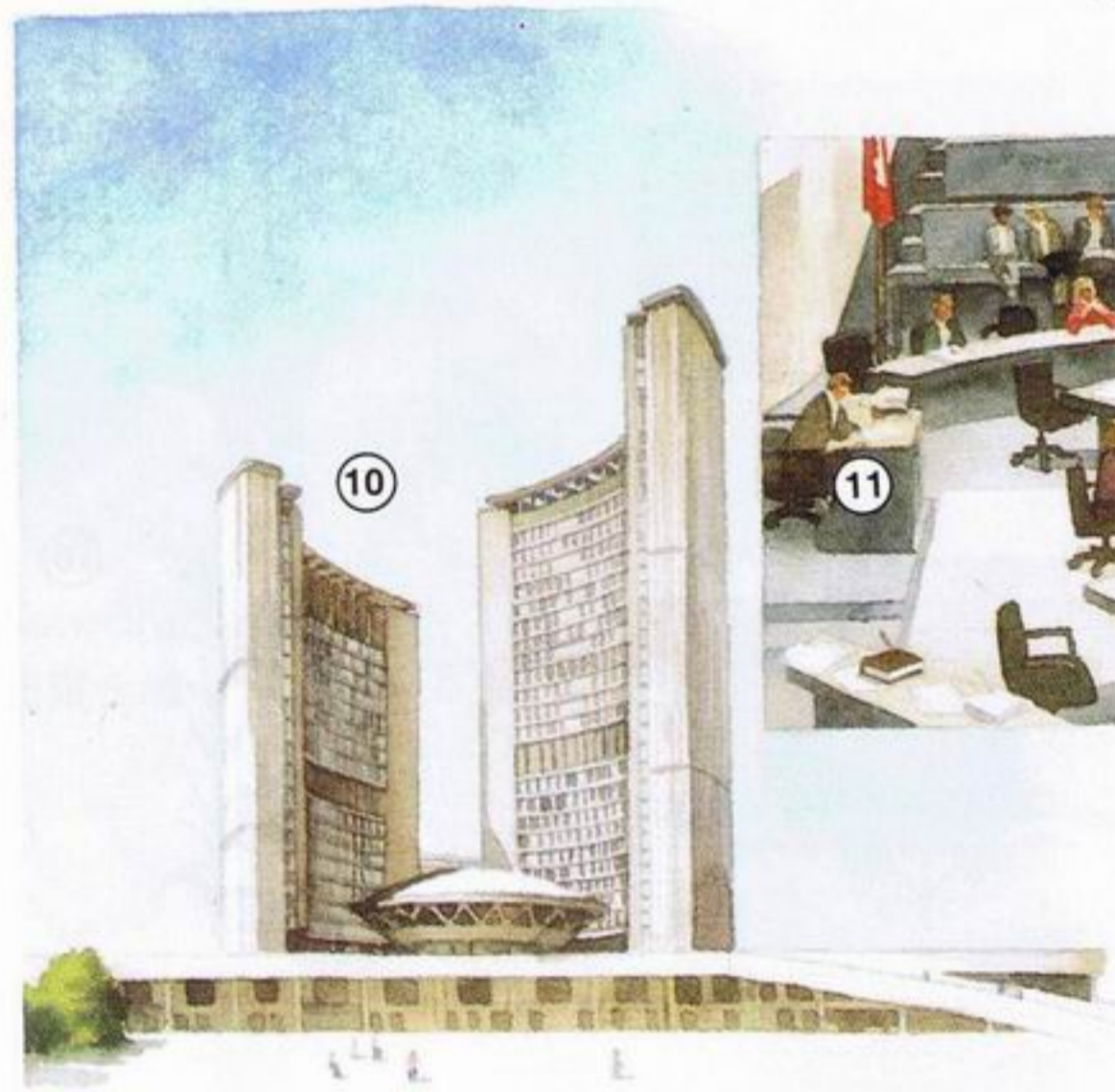
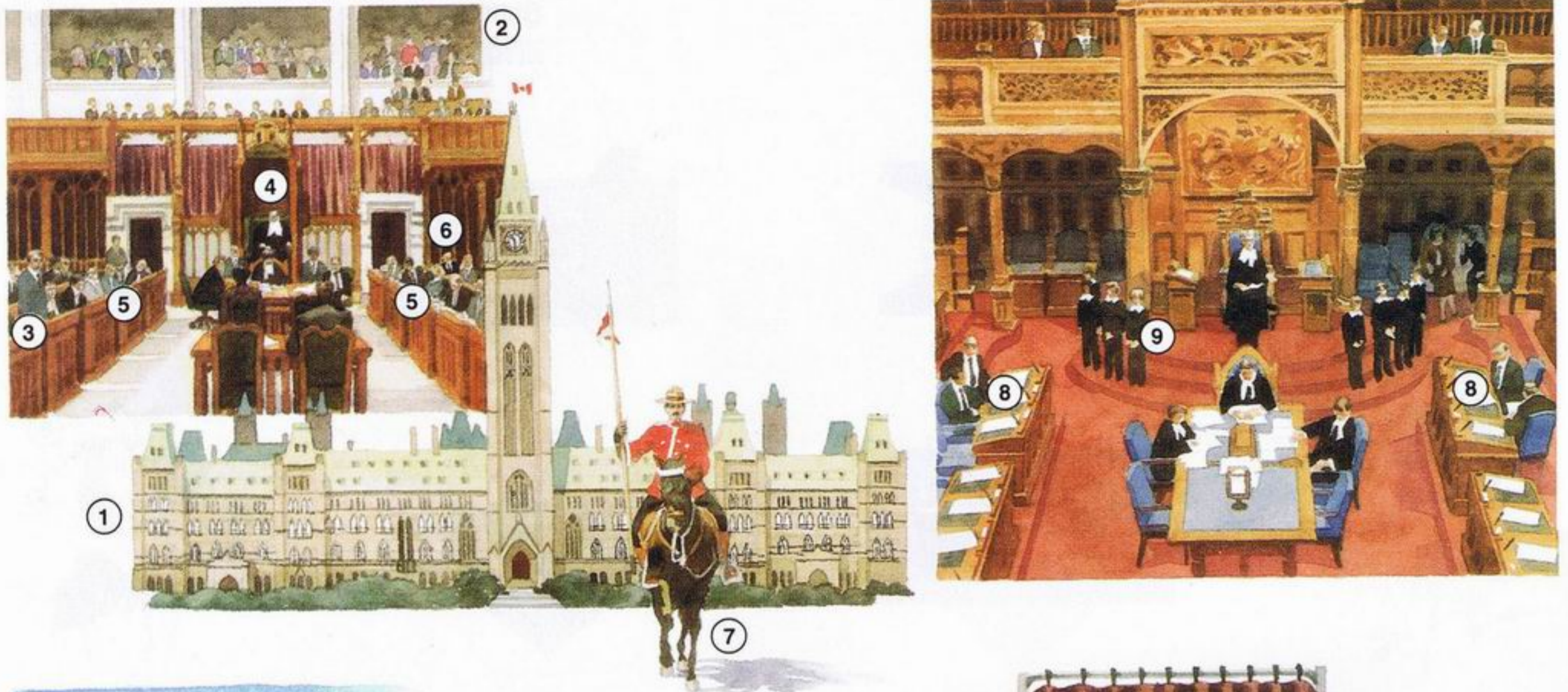

聯邦政府  
國會大廈  
聯邦國會  
總理  
議長  
國會議員  
反對  
加拿大騎警

**Federal Government**  
1. parliament building  
2. federal legislature  
3. Prime Minister  
4. Speaker of the House  
5. members of parliament  
6. opposition  
7. mountie

省政府  
省府官員  
侍從  
市政府  
市政廳  
市長  
市議員  
市議會

**Provincial Government**  
8. members of provincial government  
9. page

**Municipal Government**  
10. city hall  
11. mayor  
12. city counselors  
13. gallery

**Elections in Canada**  
14. voting booth  
15. ballot  
16. "to vote"  
17. candidate

加拿大  
選舉  
投票站  
選票  
“投票”  
候選人

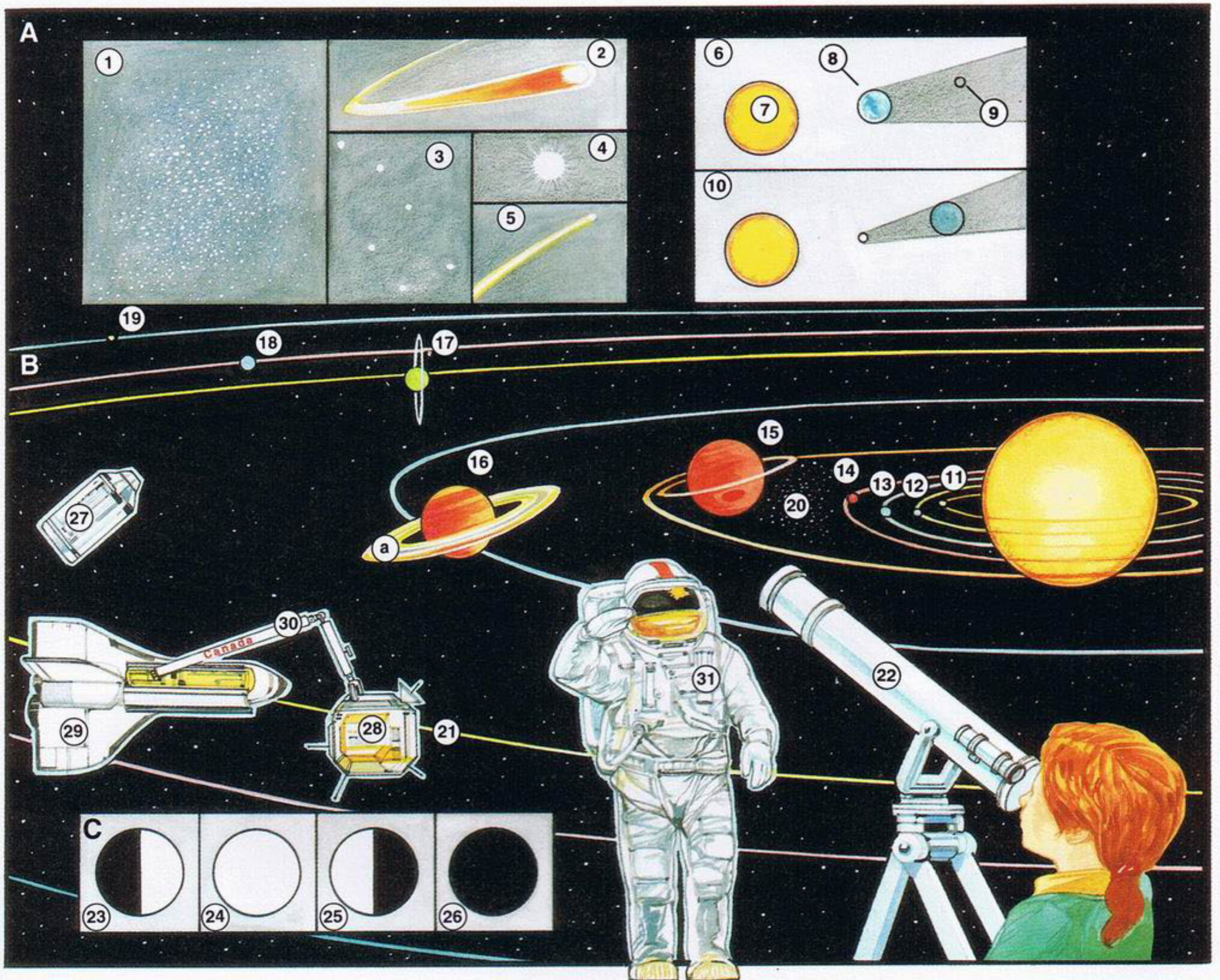

外太空  
銀河系  
彗星  
(北斗七星)  
星座  
星  
流星

**A. Outer Space**  
1. galaxy  
2. comet  
3. (Big Dipper)  
constellation  
4. star  
5. meteor

太陽系  
月蝕  
太陽  
地球  
月球  
日蝕

**B. The Solar System**  
6. lunar eclipse  
7. Sun  
8. Earth  
9. Moon  
10. solar eclipse

行星  
水星  
金星  
地球  
火星  
木星  
土星  
光環  
天王星  
海王星  
冥王星  
小行星  
軌道  
天文望遠鏡

**The Planets**  
11. Mercury  
12. Venus  
13. Earth  
14. Mars  
15. Jupiter  
16. Saturn  
a. ring  
17. Uranus  
18. Neptune  
19. Pluto  
20. asteroid  
21. orbit  
22. telescope

月亮的盈虧  
上弦月  
滿月  
下弦月  
新月

**C. Phases of the Moon**  
23. first quarter  
24. full moon  
25. last quarter  
26. new moon

漫遊太空  
火箭  
人造衛星  
穿梭機、  
太空穿梭機  
加拿大臂  
太空人

**Travel in Space**  
27. rocket  
28. satellite  
29. space shuttle  
30. Canada arm  
31. astronaut

## 能源

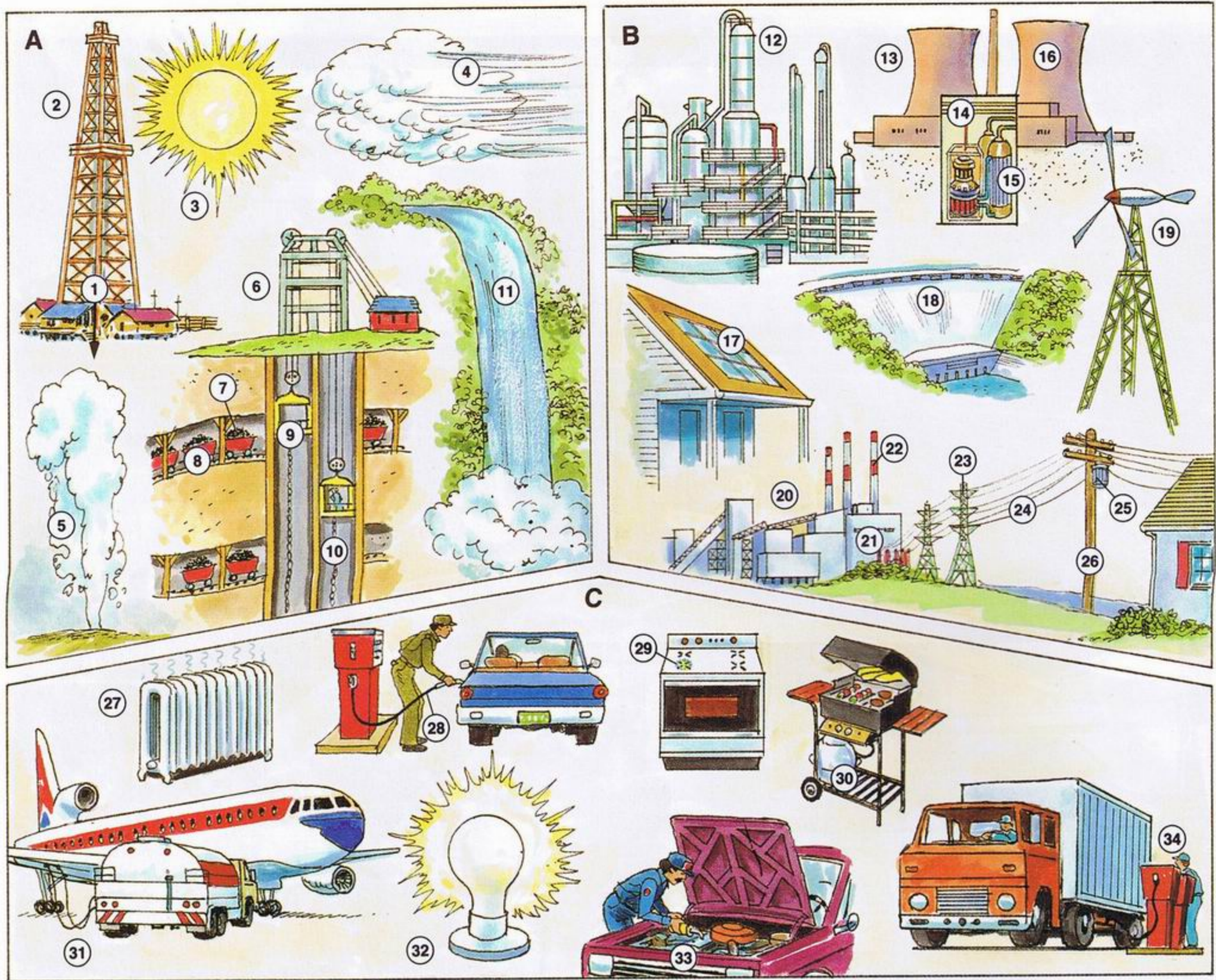

## 能量來源

## A. Sources of Power

- 油井 1. oil well  
 油井架 2. derrick  
 太陽 3. sun  
 風 4. wind  
 噴泉 5. geyser  
 煤礦 6. coal mine  
 煤 7. coal  
 運輸車 8. shuttle car  
 電梯 9. elevator  
 直坑 10. shaft  
 瀑布 11. waterfall

## 能量的產生

## B. Generation of Power

- 煉油廠 12. refinery  
 核子反應爐 13. nuclear reactor  
 堆蕊、活性區 14. core  
 鈾柱 15. uranium rods  
 冷卻塔 16. cooling tower  
 太陽能收集板 17. solar collector  
 水壩 18. dam  
 風車 19. windmill  
 發電站 20. power station  
 發電機 21. electrical generator  
 煙囪 22. smokestack

## 輸電塔 23. transmission towers

高壓電線 24. power lines

變壓器 25. transformer

電燈柱 26. utility pole

## 使用及產品

## C. Uses and Products

熱 27. heat

汽油 28. gas(oline)

天然氣 29. natural gas

丙烷氣體 30. propane gas

飛機燃油 31. jet fuel

電 32. electricity

機油 33. motor oil

柴油 34. diesel fuel

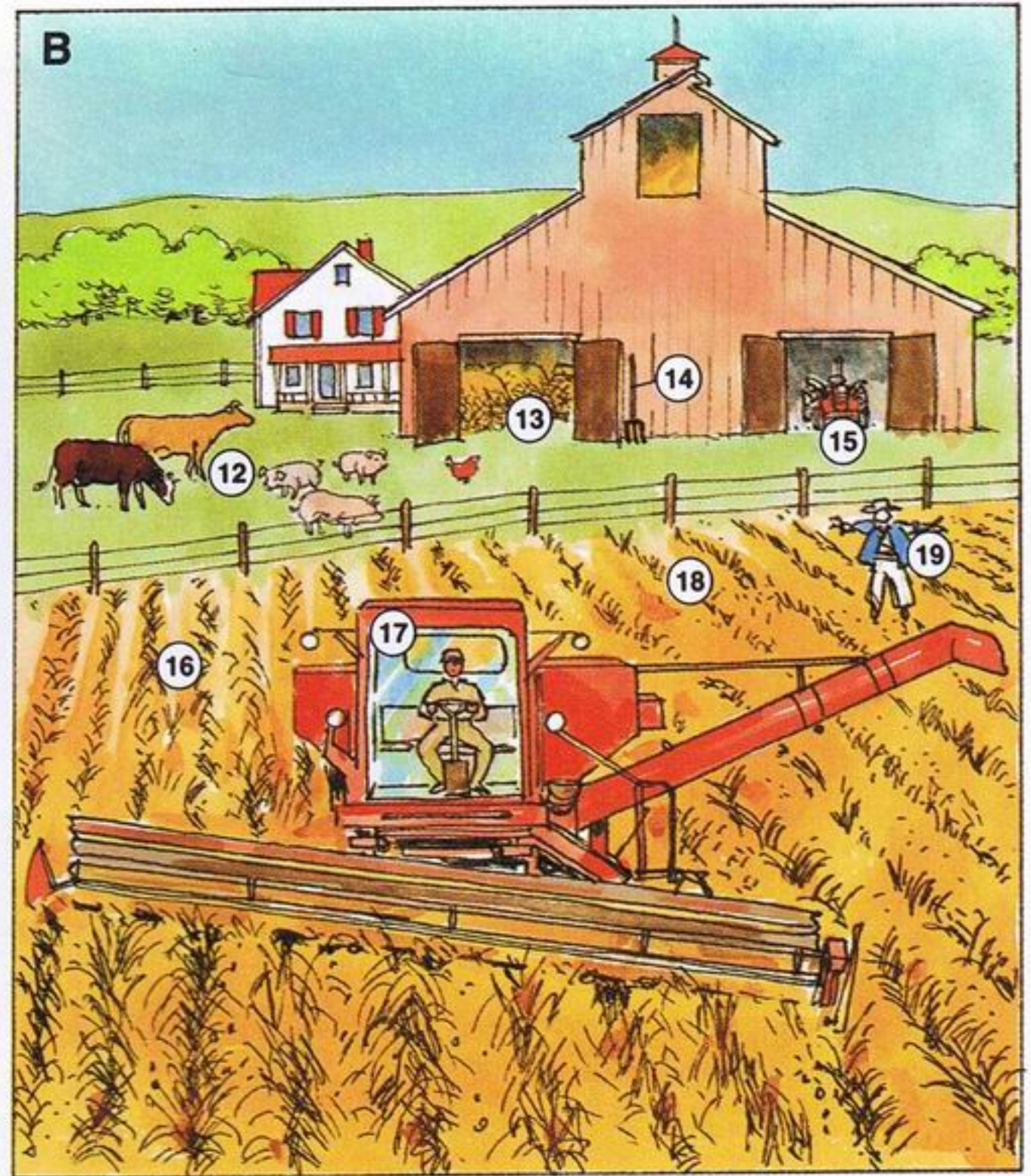
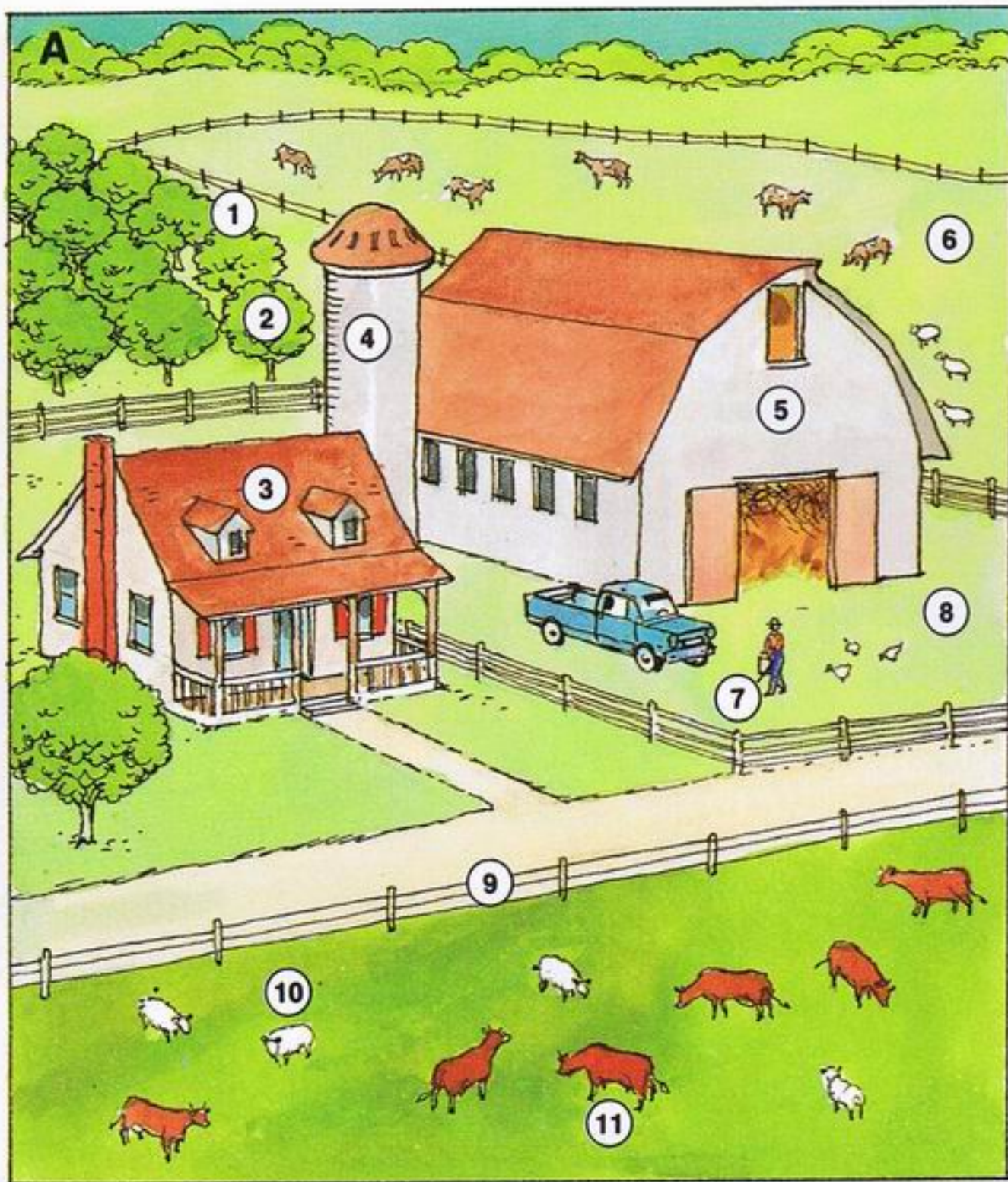

鮮奶牧場、乳牛場 **A. Dairy Farm**

- 果園 1. orchard
- 果樹 2. fruit tree
- 農家 3. farmhouse
- 稻草儲藏塔 4. silo
- 穀倉 5. barn
- 大草地 6. pasture
- 農夫、農民、農人 7. farmer
- 穀倉空地 8. barnyard
- 欄干 9. fence
- 羊 10. sheep
- 乳牛 11. dairy cow

小麥場 **B. Wheat Farm**

- 家畜 12. livestock
- 乾草 (堆) 13. (bale of) hay
- 草叉 14. pitchfork
- 拖拉機 15. tractor
- 小麥 (田) 16. (wheat) field
- 聯合收割機 17. combine
- 行、排 18. row
- 稻草人 19. scarecrow

牧場 **C. Ranch**

- 牛 (群) 20. (herd of) cattle
- 牛仔 21. cowboy
- 牛女 22. cowgirl
- 馬、馬匹 23. horses
- 家畜欄干 24. corral
- 細長馬槽 25. trough

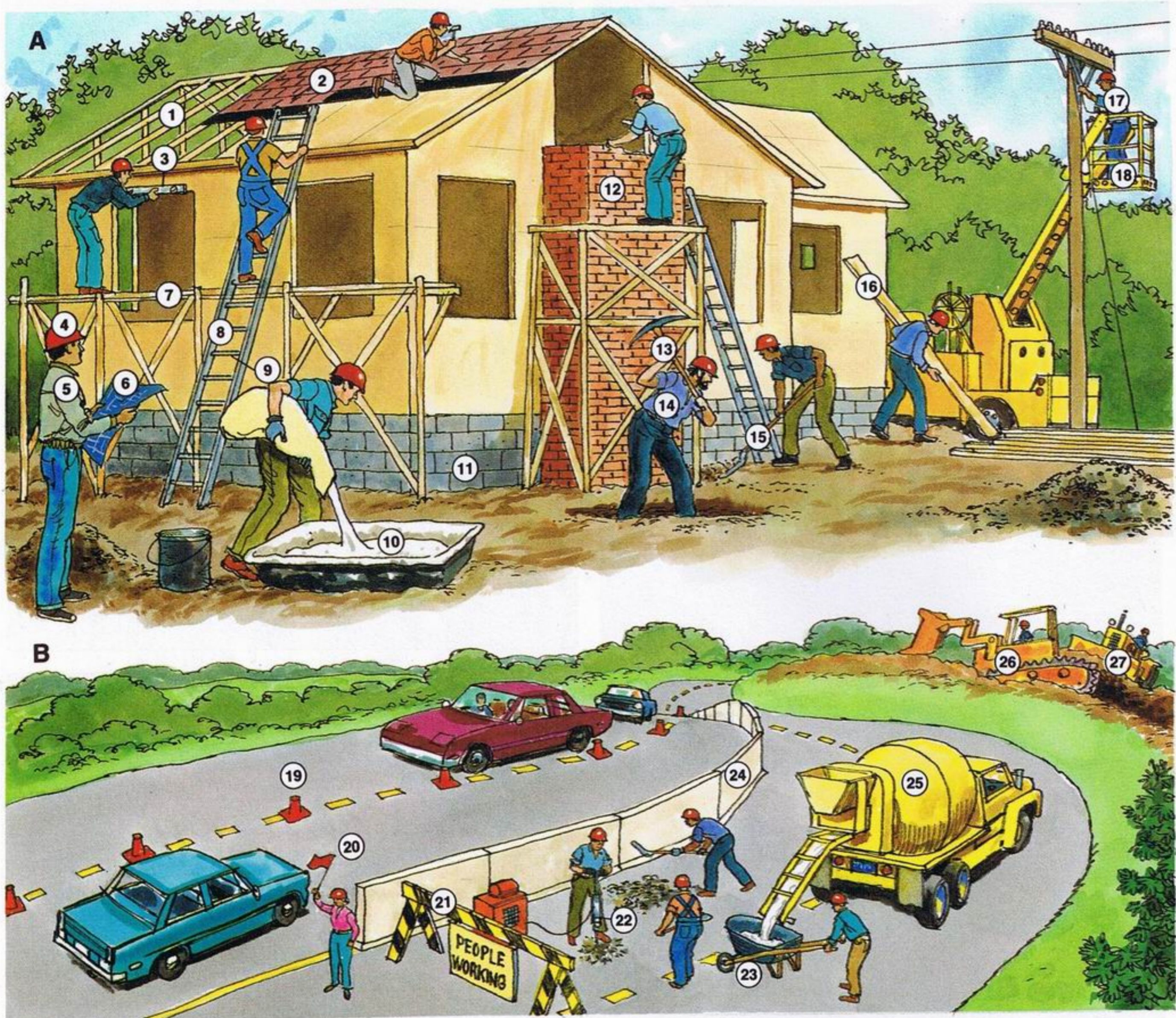

建築地盤、地盤、建築工地  
椽  
瓦片  
水平尺  
安全帽、頭盔  
承包商、管工  
藍圖  
棚架  
梯  
梯級、橫木  
水泥  
地基

### A. Construction Site

1. rafters
2. shingle
3. level
4. hard hat
5. builder
6. blueprints
7. scaffolding
8. ladder
9. rung
10. cement
11. foundation

- 磚  
鶴嘴鋤  
建築工人、地盤工人  
鏟  
木板  
電線接駁工人  
升降機
12. bricks
  13. pickax
  14. construction worker
  15. shovel
  16. board
  17. linesman
  18. cherry picker

### B. Road Work

- 道路工程  
雪糕筒  
旗
19. cone
  20. flag

- 路障  
鑽地機  
擔泥車  
中間護土牆  
水泥攪拌車  
堆土機  
鏟泥車
21. barricade
  22. jackhammer
  23. wheelbarrow
  24. centre divider
  25. cement mixer
  26. backhoe
  27. bulldozer

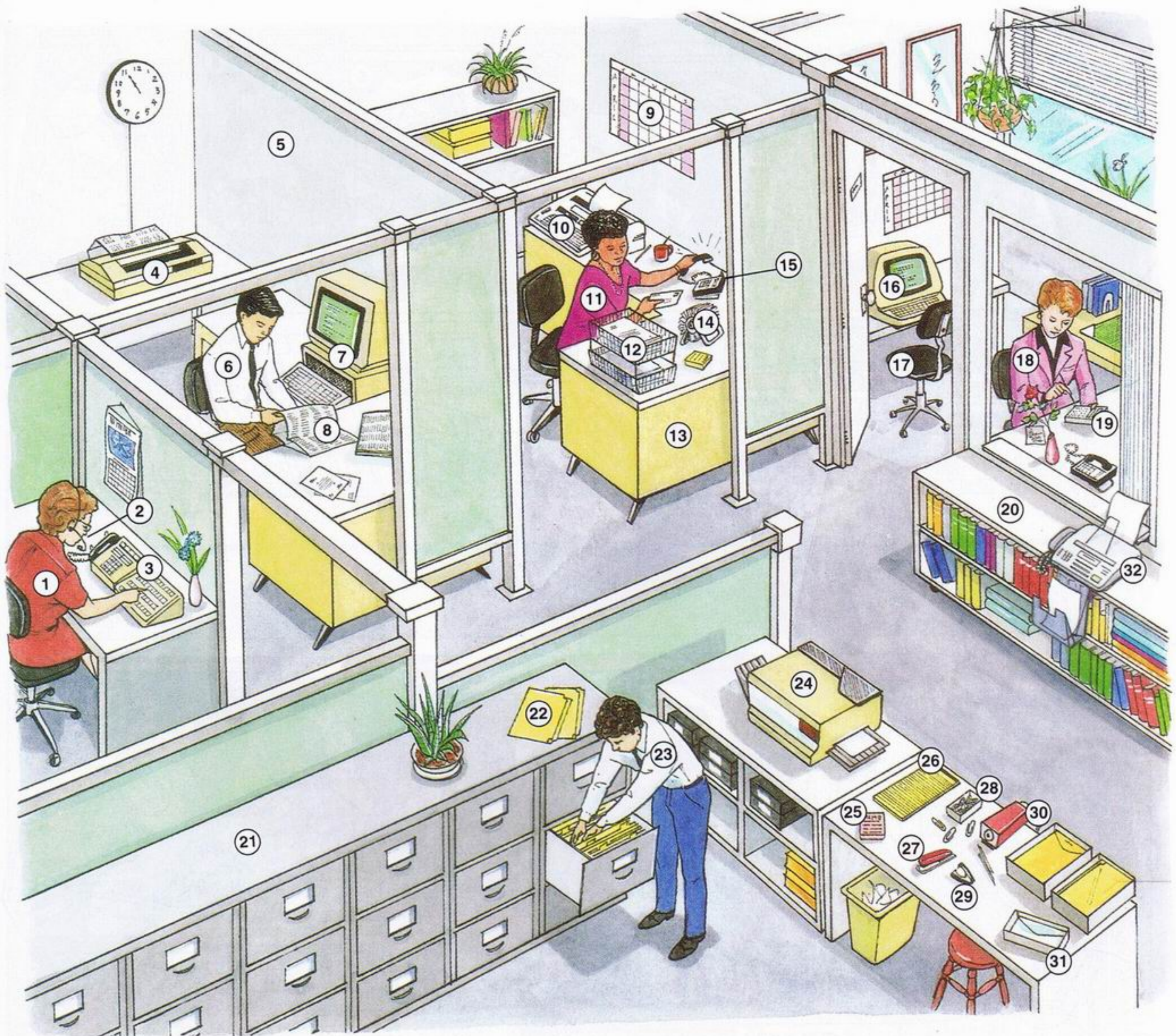

- |           |                         |            |                  |         |                      |
|-----------|-------------------------|------------|------------------|---------|----------------------|
| 接線生       | 1. switchboard operator | 放置外來文件的文件架 | 12. in-box       | 文件夾、檔案夾 | 22. file folder      |
| 耳筒        | 2. headset              | 書枱         | 13. desk         | 檔案文員    | 23. file clerk       |
| 接線板       | 3. switchboard          | 環形索引夾      | 14. rolodex      | 影印機     | 24. photocopier      |
| 印刷機       | 4. printer              | 電話         | 15. telephone    | 留言簿     | 25. message pad      |
| 間隔        | 5. cubicle              | 電腦         | 16. computer     | 長的筆記簿   | 26. (legal) pad      |
| 打字員       | 6. typist               | 打字椅、打字機    | 17. typing chair | 釘書機     | 27. stapler          |
| 文字處理機     | 7. word processor       | 經理         | 18. manager      | 萬字夾     | 28. paper clips      |
| 電腦印刷出來的文件 | 8. printout             | 計算機        | 19. calculator   | 起釘機     | 29. stapler remover  |
| 月曆        | 9. calendar             | 書架         | 20. bookcase     | 鉛筆刨     | 30. pencil sharpener |
| 打字機       | 10. typewriter          | 文件柜、檔案櫃    | 21. file cabinet | 信封      | 31. envelope         |
| 秘書        | 11. secretary           |            |                  | 傳真機     | 32. fax machine      |

職業一



- |                 |                  |
|-----------------|------------------|
| 藥劑師             | 1. pharmacist    |
| 汽車修理技師、<br>車房師傅 | 2. mechanic      |
| 理髮師             | 3. barber        |
| 旅行社經紀、<br>旅行社職員 | 4. travel agent  |
| 修理工人、維修工人       | 5. repair person |
| 裁縫              | 6. tailor        |

- |          |                 |
|----------|-----------------|
| 雜貨店職員    | 7. grocer       |
| 麵包師傅、麵包師 | 8. baker        |
| 驗光師、光學師  | 9. optician     |
| 髮型設計師    | 10. hairdresser |
| 花商       | 11. florist     |
| 珠寶商      | 12. jeweller    |
| 屠夫       | 13. butcher     |



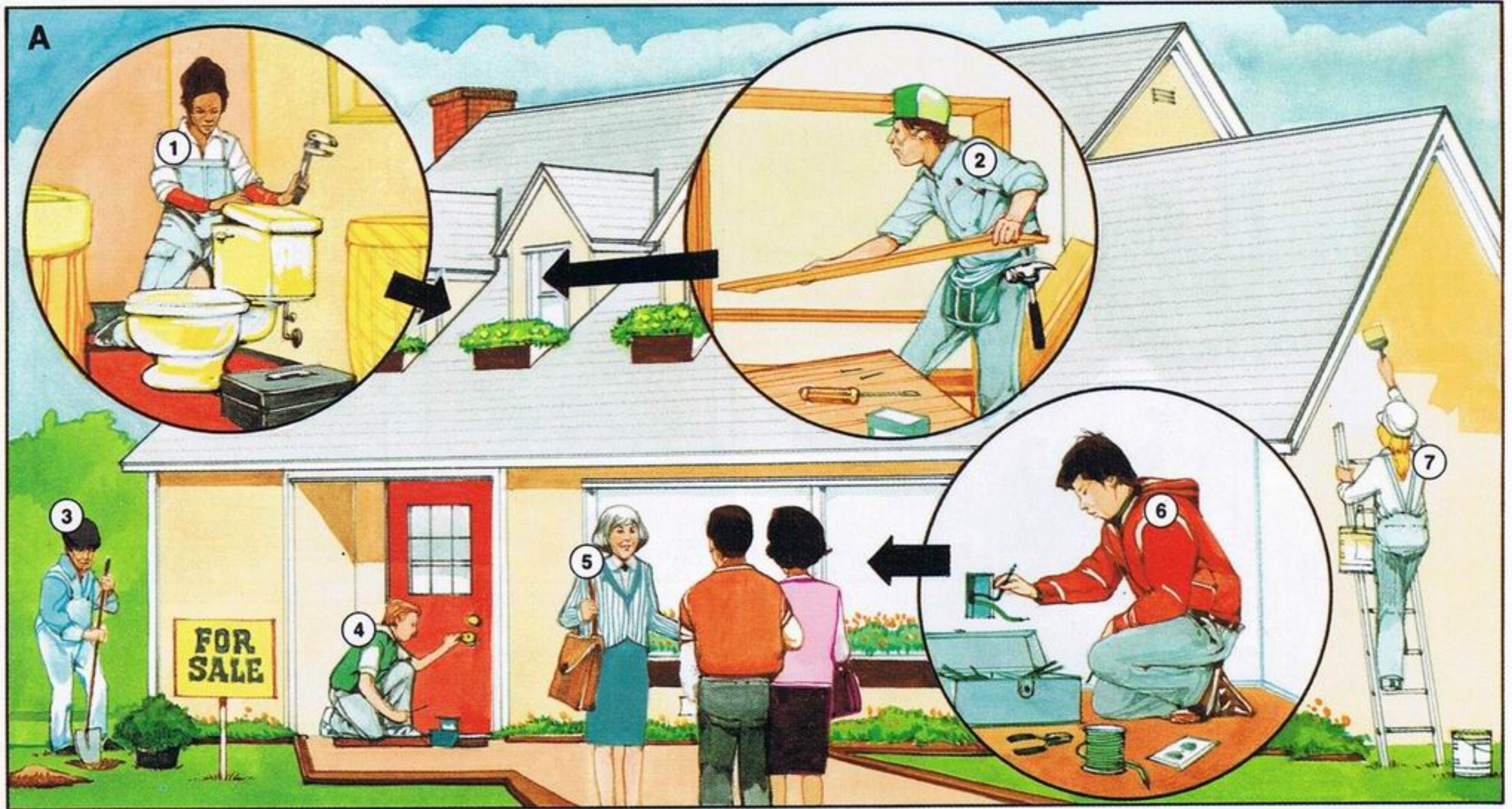

- 維修與保養  
水喉工人、水喉匠  
木匠  
園丁  
鎖匠  
地產代理商  
電工  
油漆工人
- A. Repair and Maintenance**  
1. plumber  
2. carpenter  
3. gardener  
4. locksmith  
5. real estate agent  
6. electrician  
7. painter

- 家庭服務  
家庭幫工  
清潔工人  
送貨人  
看更
- B. Household Services**  
8. housekeeper  
9. janitor  
10. delivery person  
11. doorman
- 工廠工作  
工廠工人  
管工、科文
- C. Factory Work**  
12. shop worker  
13. foreman

職業三



傳播媒介及藝術  
天氣報告員  
新聞播報員  
藝術家  
攝影家  
模特兒  
時裝設計師、  
服裝設計師  
作家  
建築師

**A. Media and Arts**  
1. weather forecaster  
2. newscaster  
3. artist  
4. photographer  
5. model  
6. fashion designer  
7. writer  
8. architect

宣佈員/唱片  
騎師(D.J.)  
攝影師  
記者  
推銷員  
銀行業  
主管  
警衛  
出納員

**B. Banking**  
9. announcer/disc  
jockey (D.J.)  
10. cameraperson  
11. reporter  
12. salesperson  
13. officer  
14. security guard  
15. teller

商業服務員  
電腦操作員  
**C. Business Workers**  
16. computer  
programmer  
17. receptionist  
18. accountant  
19. messenger



- 動物園 1. zoo  
 樂隊演奏場地 2. band shell  
 小販 3. vendor  
 手推車 4. hand cart  
 旋轉木馬 5. merry-go-round  
 騎士 6. horseback rider  
 騎馬專用徑 7. bridle path  
 (鴨)池 8. (duck) pond  
 緩步徑 9. jogging path  
 長櫈 10. bench

- 垃圾桶 11. trash can  
 滑梯 12. slide  
 沙池 13. sandbox  
 噴水器 14. sprinkler  
 公園 15. playground  
 鞦韆 16. swings  
 立體方格架 17. jungle gym  
 搖搖板 18. seesaw  
 飲用噴泉 19. water fountain



高原、高地 1. plateau  
 遠足人士 2. hikers  
 峽谷 3. canyon  
 丘陵、小山 4. hill  
 公園管理員 5. conservation officer

釣魚 6. stream  
 溪 7. fishing rod  
 魚竿 8. fishing line  
 魚線 9. fishing net  
 魚網 10. waders  
 釣魚用防水長靴 11. rocks  
 石頭

**Fishing****Picnic Area**

野餐地方 12. grill  
 燒烤爐 13. picnic basket  
 野餐籃 14. thermos  
 暖水壺、保暖壺 15. picnic table  
 野餐枱



划艇 **Rafting**  
 艇 16. raft  
 急流 17. rapids  
 瀑布 18. waterfall

爬山 **Mountain Climbing**  
 山 19. mountain  
 山頂 20. peak  
 懸崖 21. cliff  
 綁帶 22. harness  
 繩 23. rope

露營 **Camping**  
 帳幕 24. tent  
 戶外煮食爐 25. camp stove  
 睡袋 26. sleeping bag  
 裝備 27. gear  
 有架背囊 28. frame backpack  
 照明燈 29. lantern  
 樁 30. stake  
 營火 31. campfire  
 樹木 32. woods



- |       |                      |      |                   |         |                    |
|-------|----------------------|------|-------------------|---------|--------------------|
| 海濱大道  | 1. boardwalk         | 救生圈  | 9. life preserver | 水桶      | 16. pail           |
| 小食攤檔  | 2. refreshment stand | 救生艇  | 10. lifeboat      | 鏟       | 17. shovel         |
| 汽車酒店  | 3. motel             | 沙灘波  | 11. beach ball    | 泳衣、游泳衣、 | 18. bathing suit   |
| 踩單車的人 | 4. biker             | 沙丘   | 12. sand dunes    | 游水衣、游水衫 |                    |
| 口哨    | 5. whistle           | 飛碟   | 13. Frisbee™      | 晒日光浴的人  | 19. sunbather      |
| 救生員   | 6. lifeguard         | 太陽眼鏡 | 14. sunglasses    | 沙灘椅     | 20. beach chair    |
| 望遠鏡   | 7. binoculars        | 沙灘巾  | 15. beach towel   | 沙灘太陽傘   | 21. beach umbrella |
| 救生椅   | 8. lifeguard chair   |      |                   |         |                    |



風箏、紙鳶 22. kite  
 跑步人士/  
 緩步跑人士 23. joggers/runners  
 海浪 24. wave  
 滑浪板 25. surfboard  
 充氣墊 26. air mattress  
 浮板 27. kickboard  
 泳客、  
 游泳人士 28. swimmer

水泡 29. tube  
 水 30. water  
 沙 31. sand  
 沙堆堡壘 32. sandcastle  
 泳褲、游泳  
 褲、游水褲 33. bathing trunks  
 潛水鏡 34. snorkel  
 潛水面具 35. mask

蛙鞋 36. flippers  
 氧氣筒 37. scuba tank  
 潛水衣、  
 潛水衫 38. wet suit  
 太陽油、  
 防曬油 39. suntan lotion  
 貝殼 40. shell  
 冰箱 41. cooler

球類運動

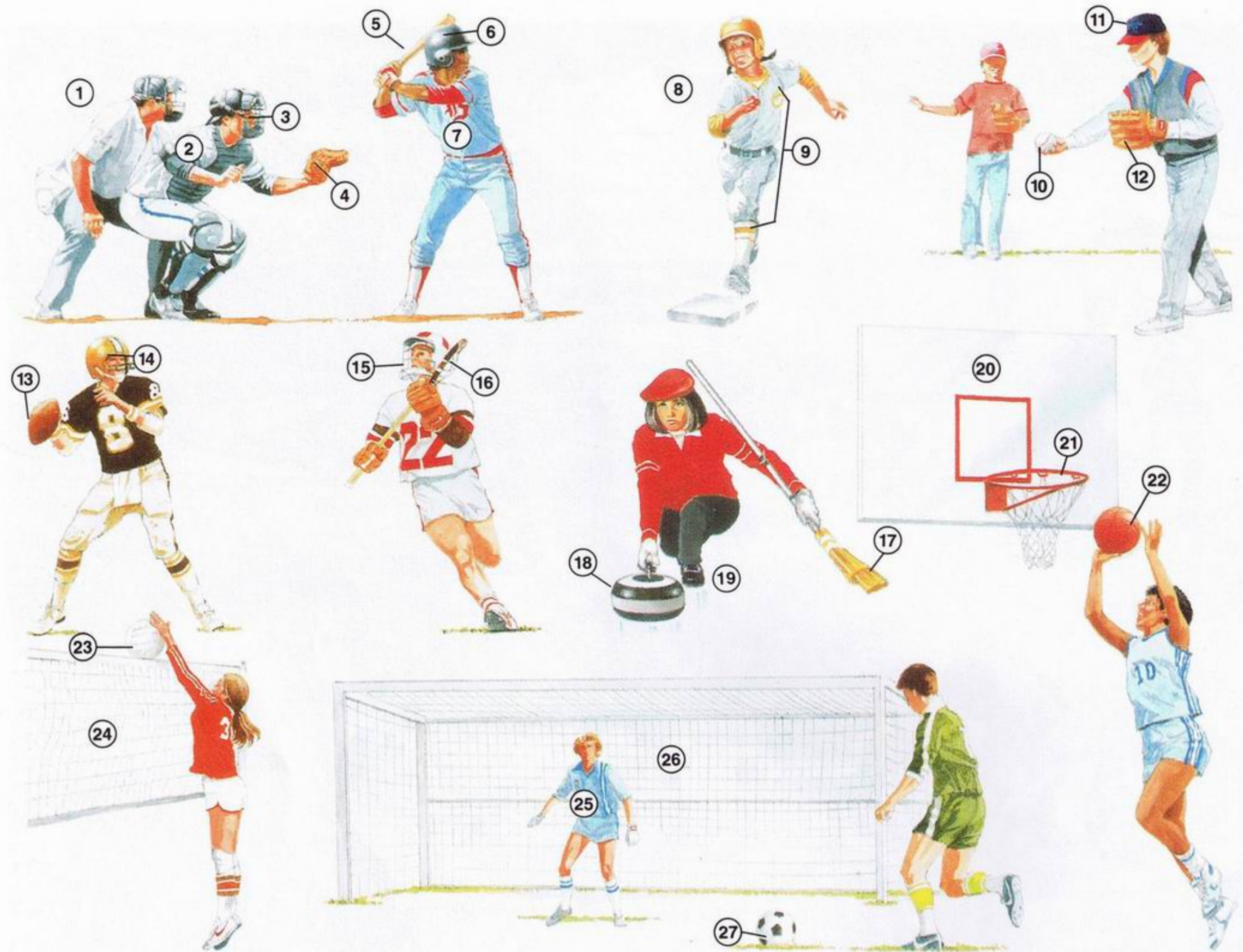

棒球 **Baseball**

- 裁判 1. umpire
- 接球手 2. catcher
- 接球手面具 3. catcher's mask
- 接球手手套 4. catcher's mitt
- 球棍 5. bat
- 頭盔 6. batting helmet
- 攻擊手 7. batter

壘球 **Softball**

- 壘球 10. softball
- 球帽 11. cap
- 手套 12. glove

籃球 **Basketball**

- 球板 20. backboard
- 籃 21. basket
- 籃球 22. basketball

美式足球 **Football**

- 美式足球 13. football
- 頭盔 14. helmet

排球 **Volleyball**

- 排球 23. volleyball
- 網 24. net

少年棒球 **Little League Baseball**

- 少棒球員 8. Little Leaguer
- 制服 9. uniform

曲棍球 **Lacrosse**

- 護面面罩、護面罩 15. face guard
- 曲棍球球棍 16. lacrosse stick

足球 **Soccer**

- 守門員、龍門 25. goalie
- 龍門 26. goal
- 足球 27. soccer ball

冰上滑石餅遊戲 **Curling**

- 掃把 17. broom
- 石頭 18. rock
- 立足點 19. hack



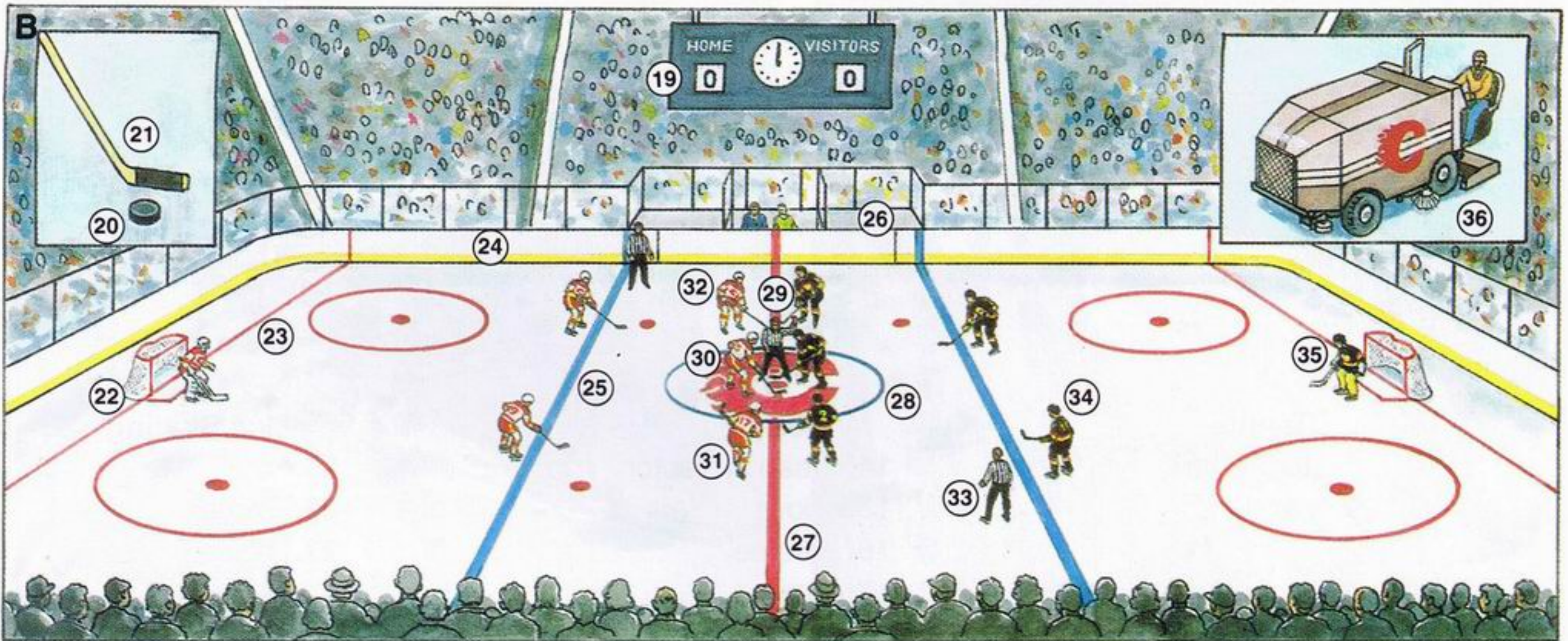
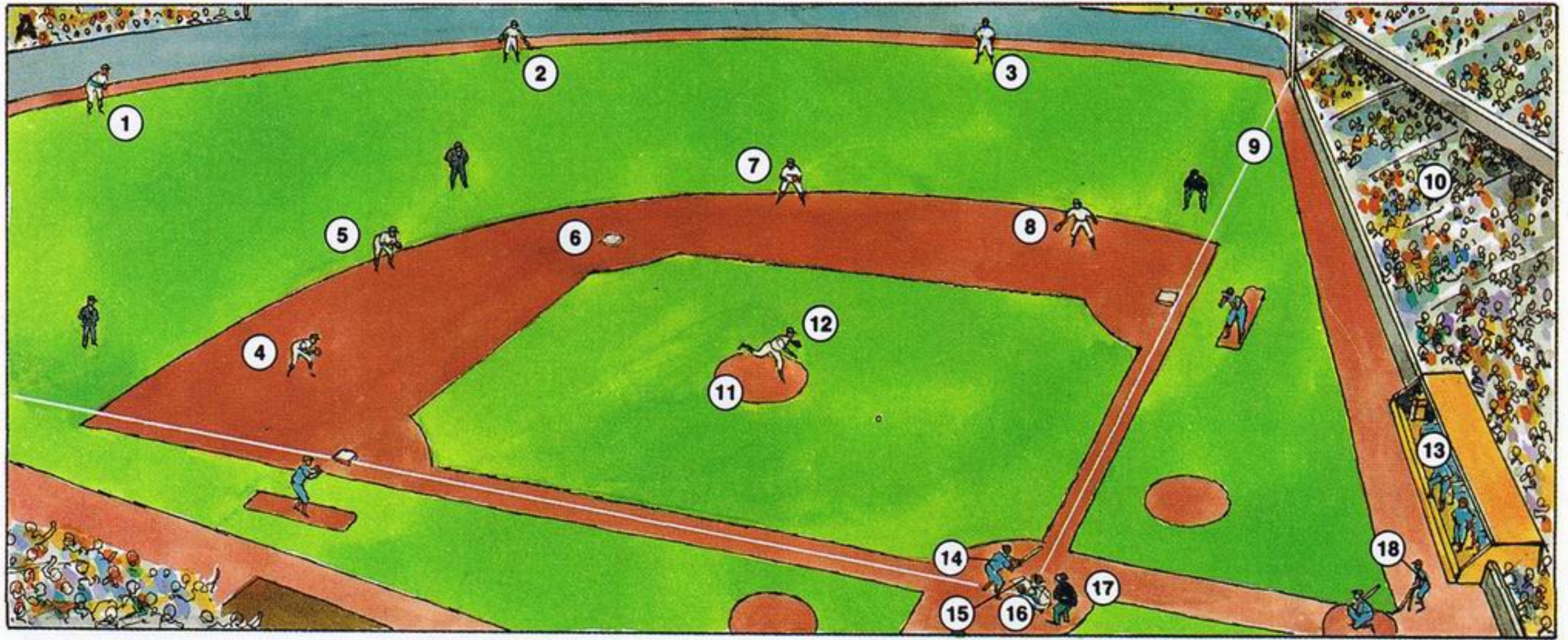

- |   |  |   |  |   |
|---|--|---|--|---|
| <p>棒球場<br/>左外野手<br/>中間手<br/>右外野手<br/>三壘手<br/>游擊手<br/>壘<br/>二壘手<br/>一壘手<br/>出局線<br/>看臺<br/>投手周圍隆起<br/>的小丘<br/>投手<br/>選手休息室</p> | <p><b>A. Baseball Diamond</b><br/>1. left fielder<br/>2. centre fielder<br/>3. right fielder<br/>4. third baseman<br/>5. shortstop<br/>6. base<br/>7. second baseman<br/>8. first baseman<br/>9. foul line<br/>10. stands<br/>11. pitcher's mound<br/>12. pitcher<br/>13. dugout</p> | <p>攻擊手<br/>本壘<br/>接球手<br/>裁判<br/>棒球球童</p> <p>冰上曲棍球<br/>計時器、時計、<br/>計分板、積分板<br/>冰上曲棍球的球<br/>冰上曲棍球棍<br/>球門<br/>球場邊線<br/>球場圍板<br/>藍線</p> | <p>14. batter<br/>15. home plate<br/>16. catcher<br/>17. umpire<br/>18. batboy</p> <p><b>B. Hockey</b><br/>19. timer/<br/>scoreboard<br/>20. puck<br/>21. hockey stick<br/>22. net<br/>23. icing line<br/>24. boards<br/>25. blue line</p> | <p>犯規球員<br/>坐監的地方<br/>紅線<br/>交鋒區<br/>裁判員<br/>中鋒<br/>右翼<br/>左翼<br/>旁證<br/>防守球員<br/>守門員、龍門<br/>鋪冰機</p> <p>26. penalty box<br/>27. red line<br/>28. face off circle<br/>29. referee<br/>30. centre player<br/>31. right wing<br/>32. left wing<br/>33. linesman<br/>34. defence player<br/>35. goalie<br/>36. ice resurfacing machine (Zamboni™)</p> |
|---|--|---|--|---|

個人運動



網球 Tennis

- 網球 1. tennis ball
- 網球拍 2. racket

保齡球 Bowling

- 坑渠 3. gutter
- 球道 4. lane
- 保齡球樽 5. pin
- 保齡球 6. bowling ball

高爾夫球 Golf

- 高爾夫球 7. golf ball
- 球洞 8. hole
- 高爾夫球球棍 9. putter
- 高爾夫球員 10. golfer

手球 Handball

- 手套 11. glove
- 手球 12. handball
- 球場 13. court

拳擊 Boxing

- 護頭 14. head protector
- 手套 15. glove
- 裁判、公證 16. referee
- 拳擊台 17. ring

乒乓球 Ping-Pong

- 乒乓球板 18. paddle
- 乒乓球 19. ping-pong ball

賽馬 Horse Racing

- 馬鞍 20. saddle
- 騎師 21. jockey
- 韁繩 22. reins

體操 Gymnastics

- 體操運動員 23. gymnast
- 平衡木 24. balance beam

溜冰 Ice Skating

- 溜冰場 25. rink
- 溜冰鞋 26. skate
- 溜冰刀 27. blade

壁球 Raquetball

- 護眼罩、眼罩 28. safety goggles
- 球拍 29. racquet
- 玩壁球的波 30. racquetball

田徑 Track and Field

- 賽跑選手 31. runner
- 跑道 32. track

越野滑雪 Cross-Country Skiing

- 雪橇 33. skis
- 棍 34. pole
- 滑雪的人、滑雪運動員 35. skier

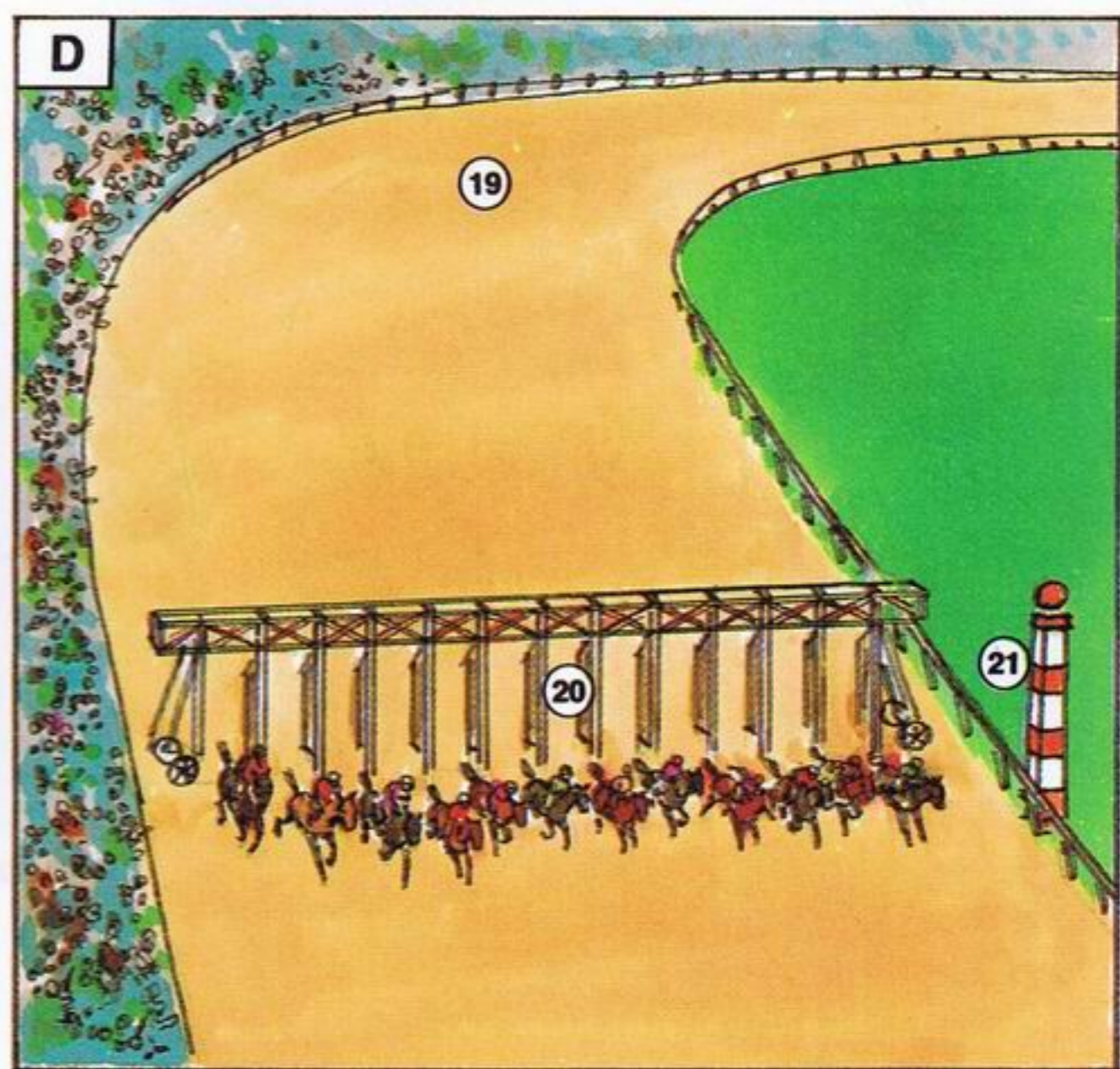
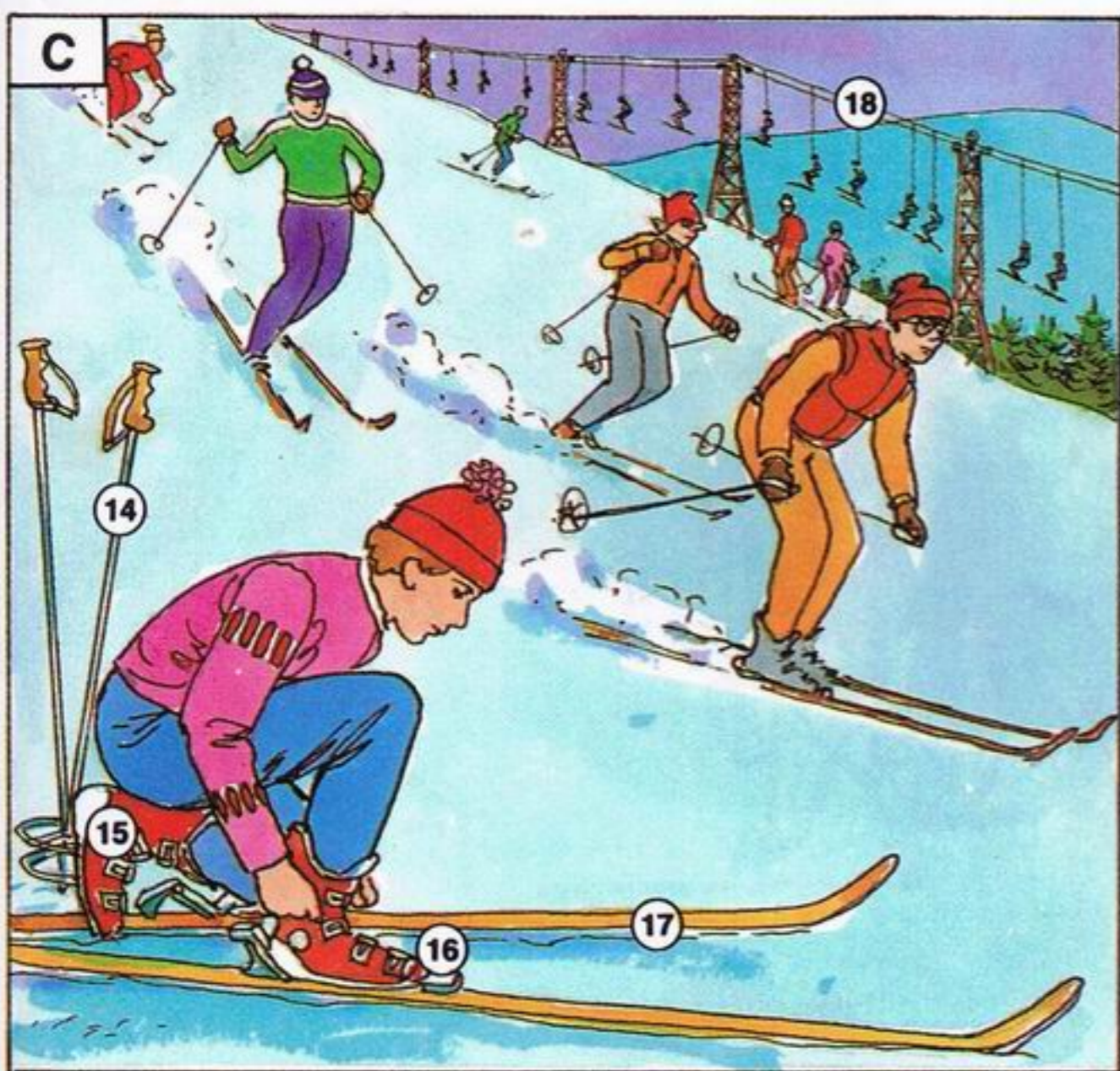
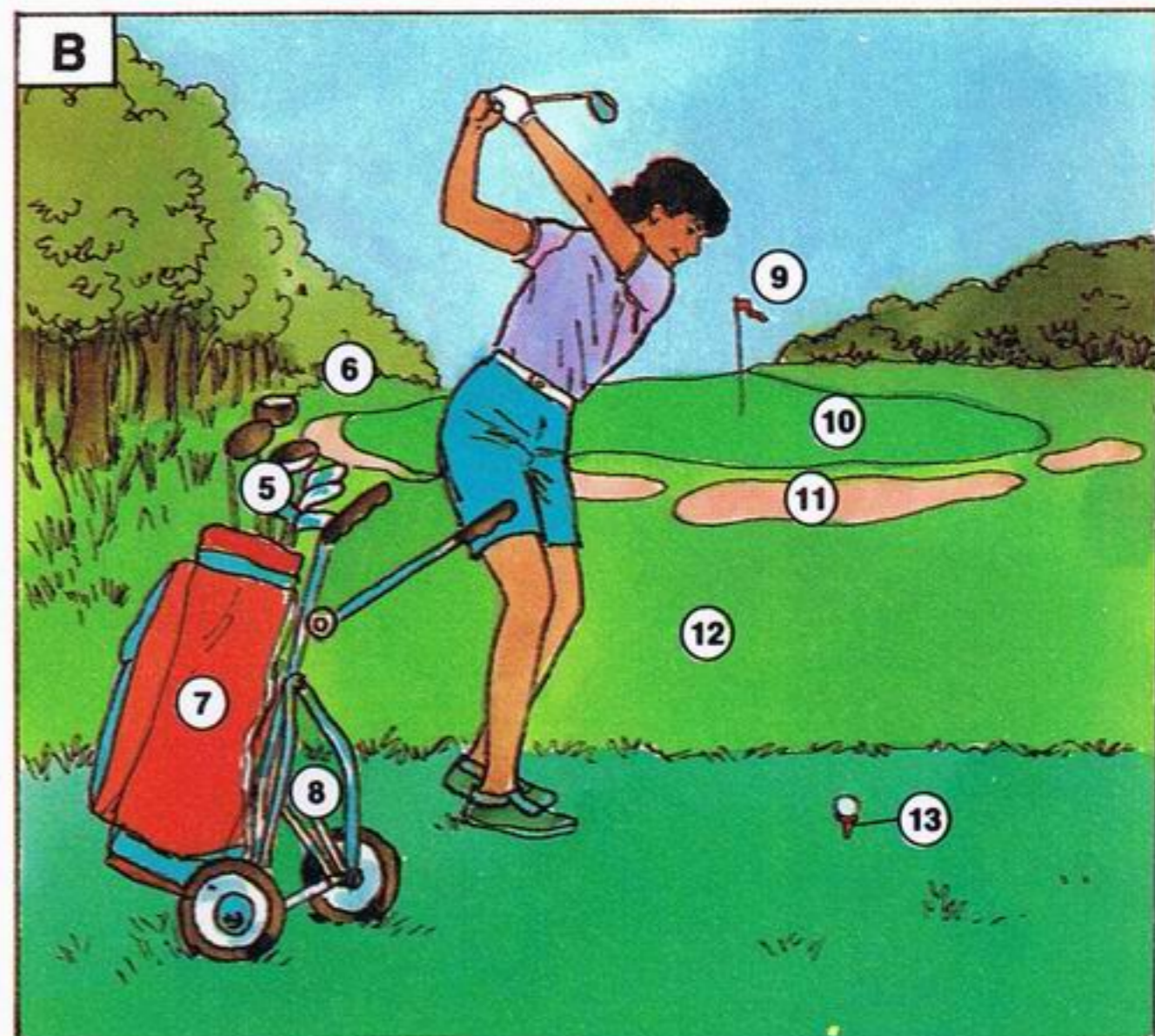
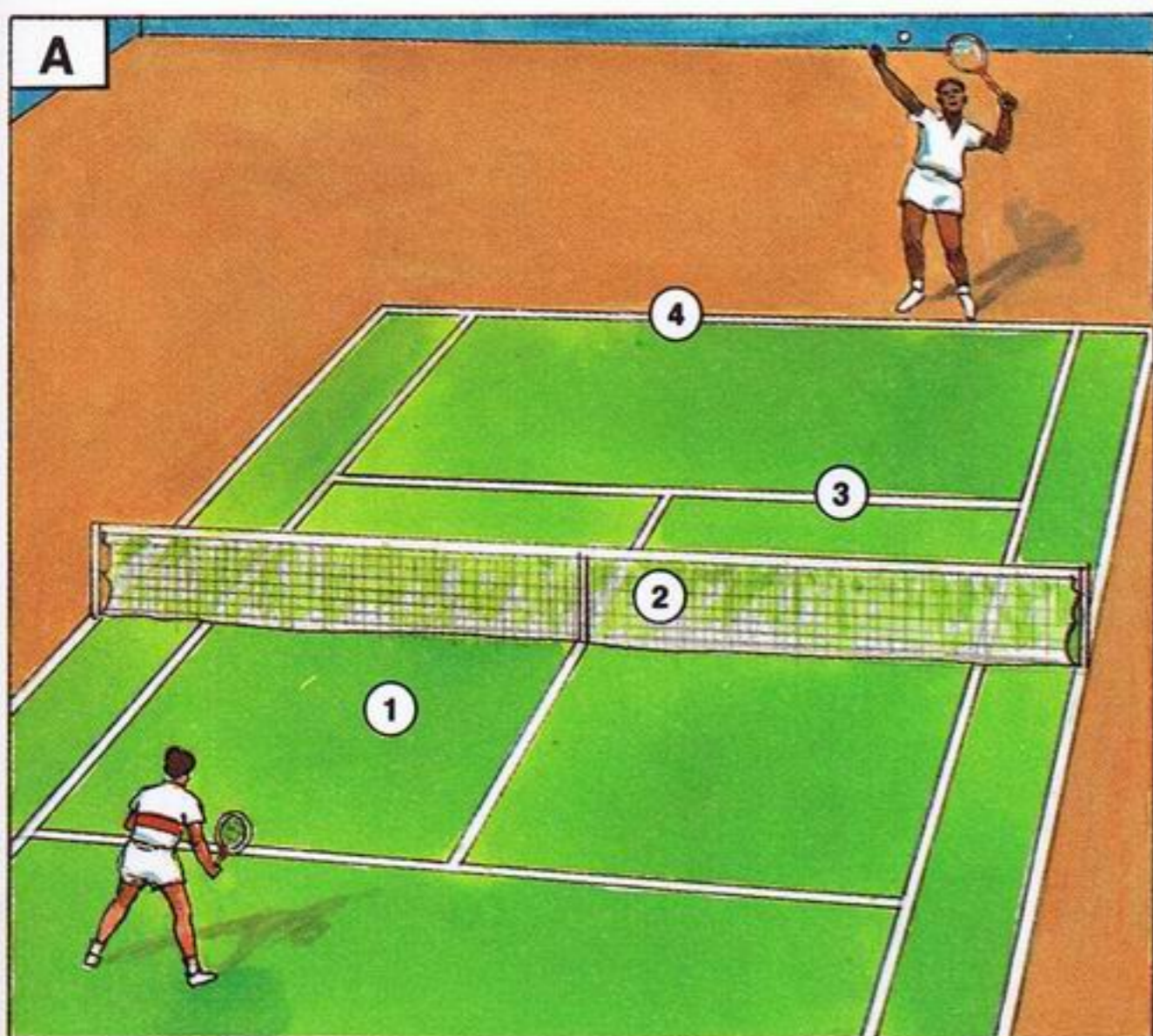

網球場  
發球落地區  
網  
發球落地不能  
超越的界線  
出界線

**A. Tennis Court**  
1. service court  
2. net  
3. service line  
4. baseline

高爾夫球棍  
高爾夫球桿  
高爾夫球場草地  
高爾夫球袋  
高爾夫球車  
旗  
綠草地  
沙池陷阱  
高爾夫球場整修  
過的草地  
球座

**B. Golf Course**  
5. clubs  
6. rough  
7. golf bag  
8. golf cart  
9. flag  
10. green  
11. sand trap  
12. fairway  
13. tee

滑雪斜坡  
棍  
滑雪靴  
綁腳帶  
雪橇  
吊車

**C. Ski Slope**  
14. pole  
15. ski boot  
16. binding  
17. ski  
18. ski lift

馬場  
跑道  
開跑閘  
終點線

**D. Race Track**  
19. stretch  
20. starting gate  
21. finish line

運動用詞 (動詞)

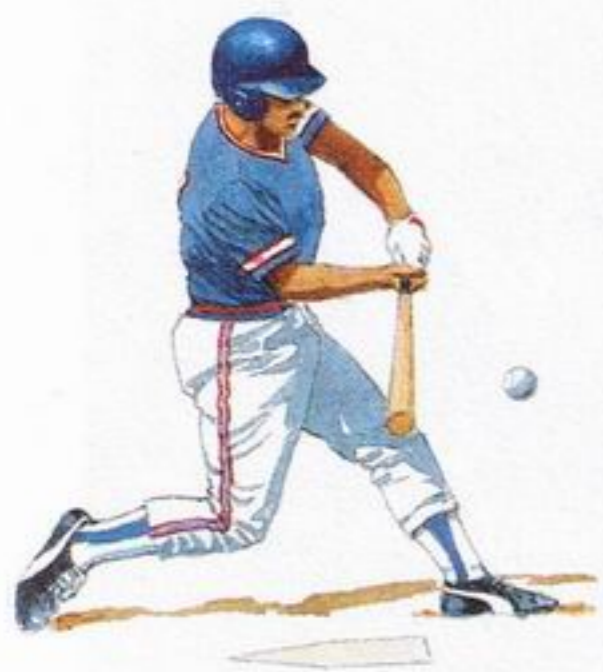

①



②



③



④

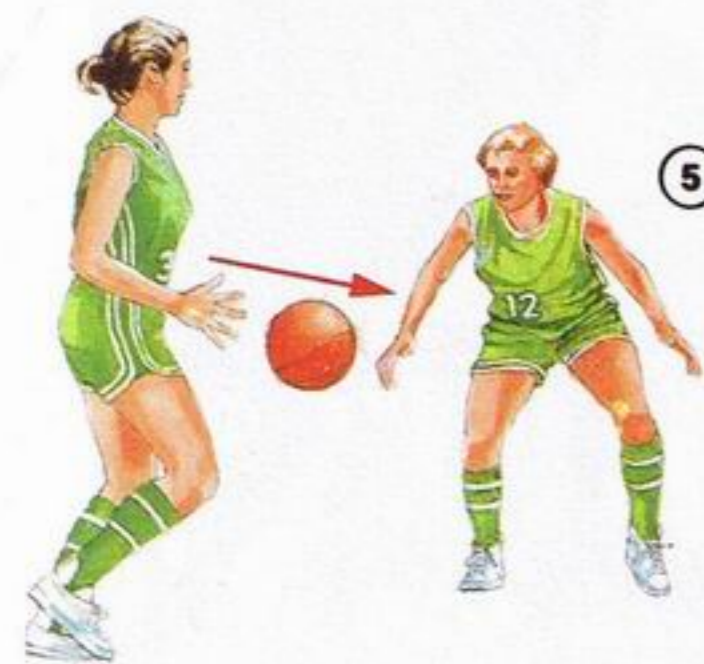

⑤

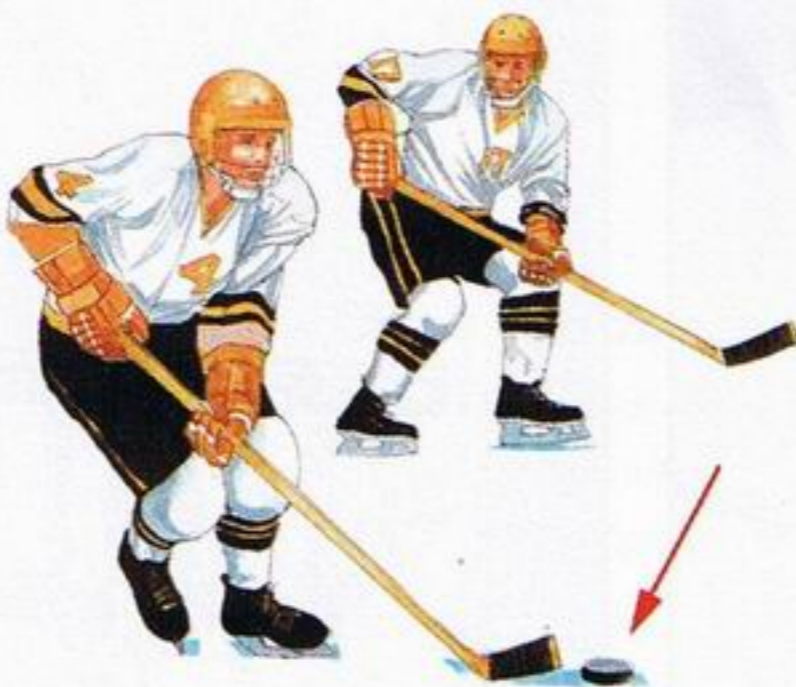

⑥



⑦



⑧



打 1. hit  
發 2. serve  
踢 3. kick  
接 4. catch

傳 5. pass  
走、跑 6. run  
跌倒 7. fall  
跳 8. jump



9



10



11



12



13



14

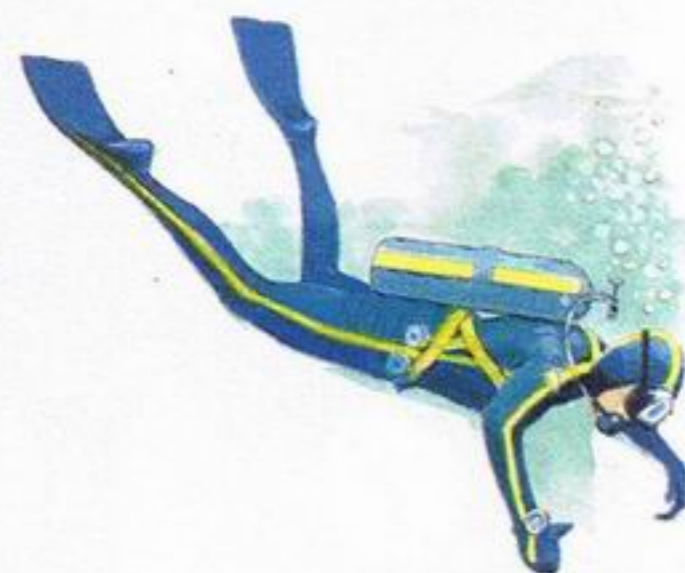

15



16



溜 9. skate  
 擲 10. throw  
 拍 11. bounce  
 滑 12. surf

騎 13. ride  
 潛 14. dive  
 開 15. drive  
 射 16. shoot

樂器



弦樂器

Strings

- 鋼琴 1. piano
- 鍵盤 a. keyboard
- 單張樂譜、散頁樂譜 2. sheet music
- 四弦琴 3. ukulele
- 曼陀林、瓢琴 4. mandolin
- 五弦琴 5. banjo
- 豎琴 6. harp
- 小提琴 7. violin
- 弓 a. bow
- 中提琴 8. viola
- 大提琴 9. cello
- 低音大提琴 10. bass
- 弦 a. string
- 結他 11. guitar
- 彈片 a. pick

木管樂器

Woodwinds

- 高音笛 12. piccolo
- 橫笛 13. flute
- 低音簧管 14. bassoon
- 雙簧管 15. oboe
- 單簧管 16. clarinet

打擊樂器

Percussion

- 搖鼓 17. tambourine
- 鑼 18. cymbals
- 鼓 19. drum
- 鼓棍 a. drumsticks
- 康茄鼓 20. conga
- 半球形銅鼓 21. kettledrum
- (古巴) 小鼓 22. bongos

銅管樂器

Brass

- 伸縮喇叭 23. trombone
- 色士風 24. saxophone
- 喇叭 25. trumpet
- 法國號 26. French horn
- 低音喇叭 27. tuba

其他樂器

Other Instruments

- 手風琴 28. accordion
- 電子琴 29. organ
- 口琴 30. harmonica
- 木琴 31. xylophone

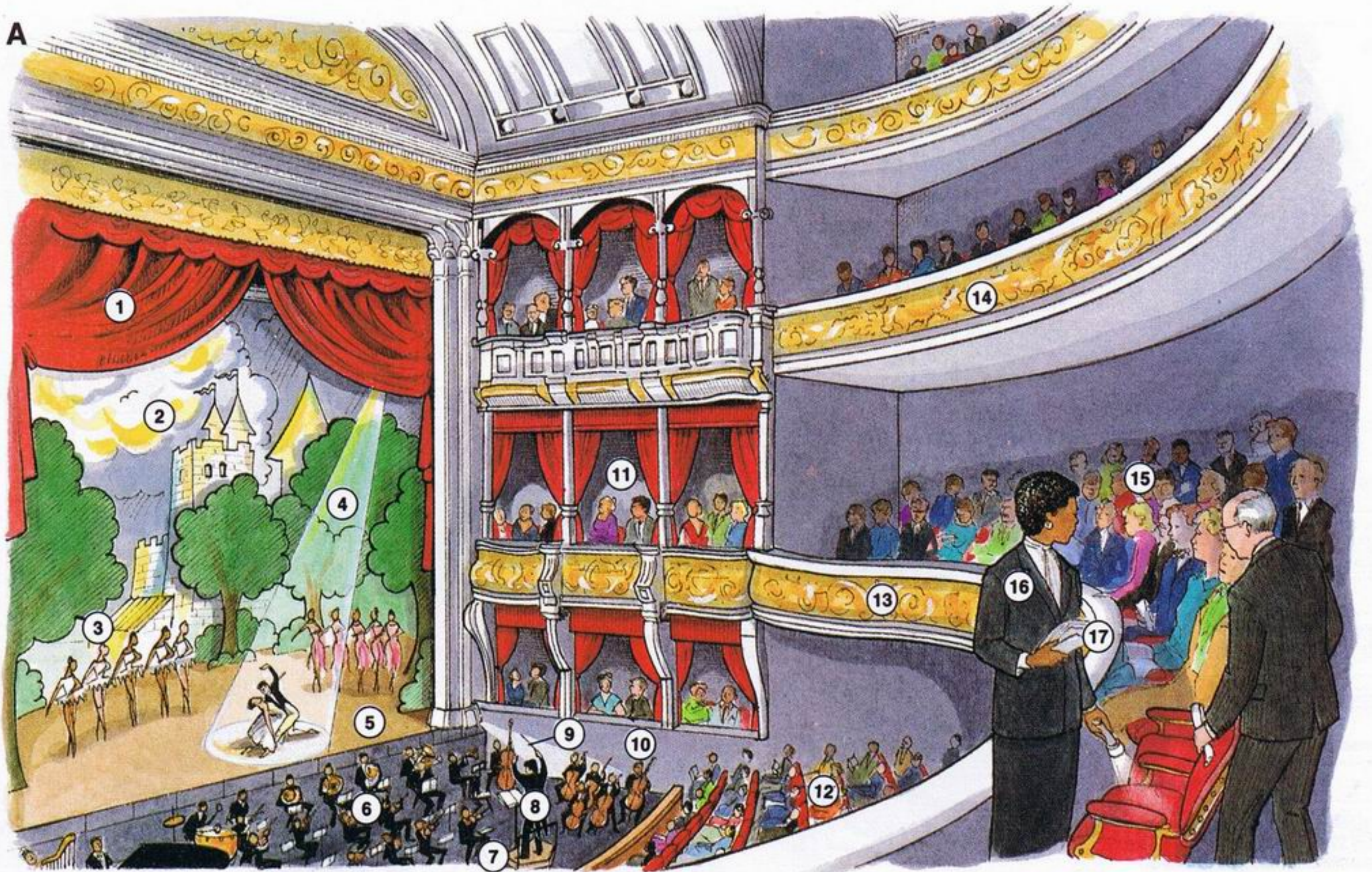

**A. The Ballet**

- 芭蕾舞 幕 1. curtain
- 佈景 2. scenery
- 舞蹈員 3. dancer
- 射燈 4. spotlight
- 舞臺 5. stage
- 樂隊 6. orchestra
- 指揮臺 7. podium
- 指揮 8. conductor

- 指揮棒 9. baton
- 音樂家 10. musician
- 包廂 11. box seat
- 樂隊席 12. orchestra seating
- 閣樓 13. mezzanine
- 樓上座位 14. balcony
- 觀眾 15. audience
- 帶位 16. usher
- 節目表 17. programs

**B. Musical Comedy**

- 合唱 18. chorus
- 男演員 19. actor
- 女演員 20. actress

**C. Rock Group**

- 音樂合成器 21. synthesizer
- 電子琴手 22. keyboard player
- 搖滾樂隊 23. bass guitarist
- 歌手 24. singer
- 主音結他手 25. lead guitarist
- 電結他 26. electric guitar
- 鼓手 27. drummer

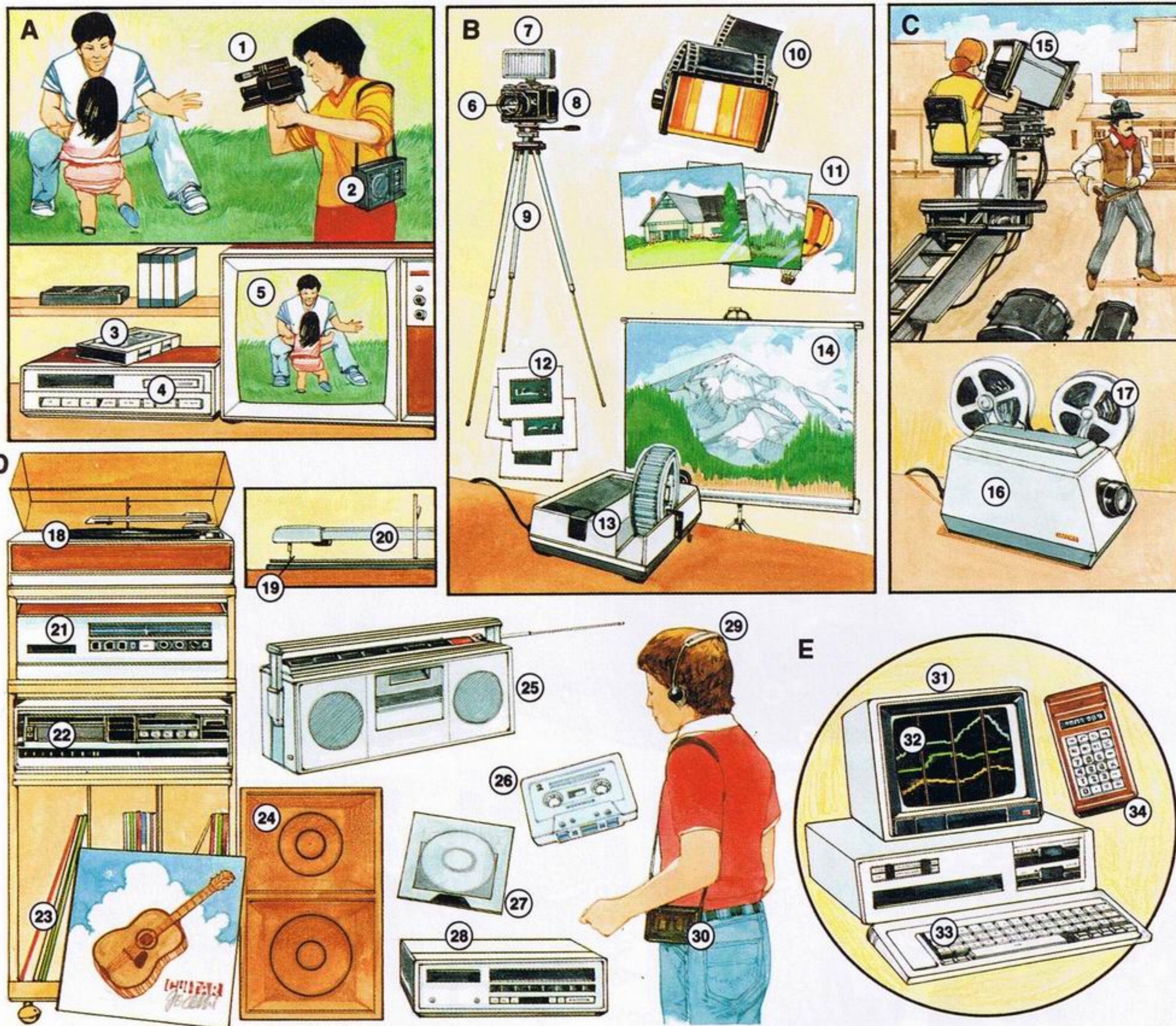

錄影  
攝錄機  
手提攝錄機  
錄影帶  
錄影機  
電視

**A. Video**  
1. video camera  
2. Minicam™  
3. videocassette (tape)  
4. VCR (videocassette recorder)  
5. television

幻燈片  
幻燈機  
銀幕  
電影  
攝影機  
放映機  
(餅)菲林

**B. Photography**  
6. lens  
7. flash  
8. camera  
9. tripod  
10. (roll of) film  
11. prints  
12. slides  
13. slide projector  
14. screen  
**C. Film**  
15. movie camera  
16. projector  
17. (reel of) film

音響  
唱盤  
唱針  
唱臂  
接收器  
錄音座

**D. Audio**  
18. turntable  
19. cartridge needle  
20. arm  
21. receiver  
22. cassette deck

唱片  
喇叭  
立體聲錄音機  
錄音帶  
光碟  
光碟機  
耳筒  
新力牌Walkman

23. records  
24. speaker  
25. stereo cassette player  
26. cassette  
27. compact disc (CD)  
28. compact disc player  
29. headphones Sony  
30. Walkman™

電腦  
個人電腦  
螢光幕、螢幕  
鍵盤  
計算機

**E. Computer**  
31. personal computer (PC)  
32. monitor  
33. keyboard  
34. calculator





- 縫紉  
衣車  
(綑) 線  
針包  
材料  
裁縫較剪  
紙樣  
款式、花樣  
鈕窿  
鈕  
線
- A. Sewing**  
1. sewing machine  
2. (spool of) thread  
3. pincushion  
4. material  
5. pinking shears  
6. pattern piece  
7. pattern  
8. buttonhole  
9. button  
10. seam

- 腳  
腳邊  
鈕  
扣  
軟尺  
拉鍊  
(把) 較剪  
針  
縫針  
大頭針  
針鼎
11. hem  
12. hem binding  
13. snap  
14. hook and eye  
15. tape measure  
16. zipper  
17. (pair of) scissors  
18. needle  
19. stitch  
20. pin  
21. thimble

- 其他針織、  
縫紉用品  
編織、織  
毛冷  
扎、束  
冷針  
針繡  
刺繡  
鉤針製品  
鉤針  
織  
紗、線  
拼縫
- B. Other  
Needlecrafts**  
22. knitting  
23. wool  
24. skein  
25. knitting needle  
26. needlepoint  
27. embroidery  
28. crochet  
29. crochet hook  
30. weaving  
31. yarn  
32. quilting



- 在 (窗口) 1. at (the window)
- 在 (黑貓) 上面 2. above (the black cat)
- 在 (白貓) 下面 3. below (the white cat)
- 在 (枕頭) 之間 4. between (the pillows)
- 在 (地毯) 上面 5. on (the rug)
- 在 (火爐) 前面 6. in front of (the fireplace)

- 在 (櫃桶) 裡面 7. in (the drawer)
- 在 (書檯) 下面 8. under (the desk)
- 在 (椅的) 後面 9. behind (the chair)
- 在 (檯的) 上面 10. on top of (the table)
- 在 (電視機) 旁邊 11. next to (the TV)

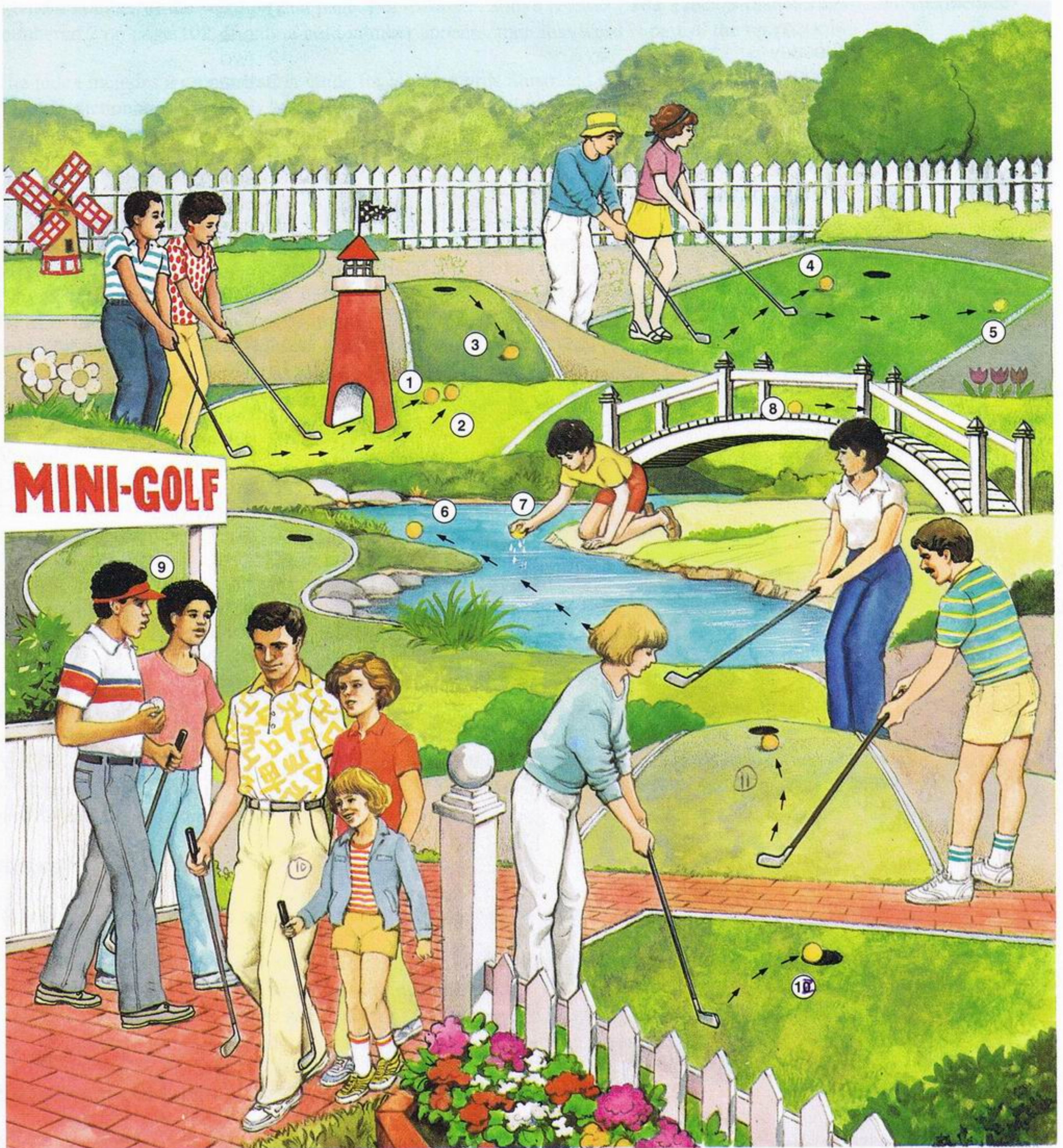

- 穿過 (燈塔) 1. through (the lighthouse)  
 圍住 (燈塔) 2. around (the lighthouse)  
 落 (山) 3. down (the hill)  
 向著 (球洞)、對準 (球洞)、對著 (球洞) 4. toward (the hole)  
 離開 (球洞) 5. away from (the hole)  
 越過 (水) 6. across (the water)

- 出 (水) 7. out of (the water)  
 過 (牆) 8. over (the bridge)  
 朝向 (球場) 9. to (the course)  
 從 (球場) 來 10. from (the course)  
 上山 11. up (the hill)  
 進入 (球洞) 12. into (the hole)









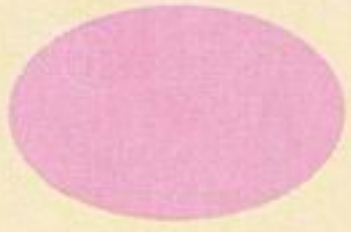

附錄

星期中的各日	Days of the Week
星期日、禮拜日	Sunday
星期一、禮拜一	Monday
星期二、禮拜二	Tuesday
星期三、禮拜三	Wednesday
星期四、禮拜四	Thursday
星期五、禮拜五	Friday
星期六、禮拜六	Saturday

月份	Months of the Year
一月	January
二月	February
三月	March
四月	April
五月	May
六月	June
七月	July
八月	August
九月	September
十月	October
十一月	November
十二月	December

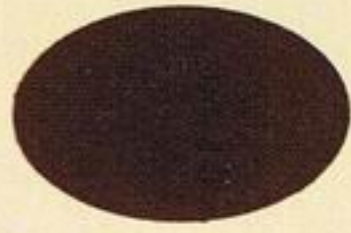
Colours

顏色

	red 紅		green 綠
	blue 藍		pink 粉紅
	yellow 黃		purple 紫
	white 白		brown 褐啡、棕
	black 黑		orange 橘
	gray 灰		

數字

Numbers

零	0 zero
一	1 one
二	2 two
三	3 three
四	4 four
五	5 five
六	6 six
七	7 seven
八	8 eight
九	9 nine
十	10 ten
十一	11 eleven
十二	12 twelve
十三	13 thirteen
十四	14 fourteen
十五	15 fifteen
十六	16 sixteen
十七	17 seventeen
十八	18 eighteen
十九	19 nineteen
二十	20 twenty
二十一	21 twenty-one
三十	30 thirty
四十	40 forty
五十	50 fifty
六十	60 sixty
七十	70 seventy
八十	80 eighty
九十	90 ninety
一百	100 a/one hundred
五百	500 five hundred
六百二十一	621 six hundred (and) twenty-one
一千	1,000 a/one thousand
一百萬	1,000,000 a/one million

Two numbers occur after words in the index: the first refers to the page where the word is illustrated and the second to the item number of the word on that page. For example, above [ə buv'] **102** 2 means that the word *above* is the item numbered 2 on page 102. If only a bold number appears, then that word is part of the unit title or a subtitle.

The index includes a pronunciation guide for all the words illustrated in the book. This guide uses symbols commonly found in dictionaries for native speakers. These symbols, unlike those used in transcription systems such as the International Phonetic Alphabet, tend to preserve spelling and so should help you to become more aware of the connec-

### Consonants

[b] as in <b>back</b> [bāk]	[k] as in <b>kite</b> [kīt]	[sh] as in <b>shell</b> [shĕl]
[ch] as in <b>cheek</b> [chĕk]	[l] as in <b>leaf</b> [lēf]	[t] as in <b>tape</b> [tāp]
[d] as in <b>date</b> [dāt]	[m] as in <b>man</b> [mān]	[th] as in <b>three</b> [thrē]
[dh] as in <b>the</b> [dh]	[n] as in <b>neck</b> [nĕk]	[v] as in <b>vine</b> [vīn]
[f] as in <b>face</b> [fās]	[ng] as in <b>ring</b> [rīng]	[w] as in <b>waist</b> [wāst]
[g] as in <b>gas</b> [gās]	[p] as in <b>pack</b> [pāk]	[y] as in <b>yam</b> [yām]
[h] as in <b>half</b> [hāf]	[r] as in <b>rake</b> [rāk]	[z] as in <b>zoo</b> [zōō]
[j] as in <b>jack</b> [jāk]	[s] as in <b>sand</b> [sānd]	[zh] as in <b>measure</b> [mĕzh'ər]

### Vowels

[ā] as in <b>bake</b> [bāk]	[ī] as in <b>lime</b> [līm]	[ōō] as in <b>cool</b> [kōōl]
[ǎ] as in <b>back</b> [bāk]	[ī] as in <b>lip</b> [līp]	[ōō] as in <b>book</b> [bōōk]
[ä] as in <b>bar</b> [bär]	[ī] as in <b>beer</b> [bīr]	[ow] as in <b>cow</b> [kow]
[ē] as in <b>beat</b> [bēt]	[ō] as in <b>post</b> [pōst]	[oy] as in <b>boy</b> [boy]
[ĕ] as in <b>bed</b> [bĕd]	[ō] as in <b>box</b> [bōks]	[ū] as in <b>cut</b> [kūt]
[ĕ] as in <b>bear</b> [bĕr]	[ö] as in <b>claw</b> [klö]	[ü] as in <b>curb</b> [kürb]
	or <b>for</b> [för]	[ə] as in <b>above</b> [ə bŭv']

All pronunciation symbols used are alphabetical except for the schwa [ə], which is the most frequent vowel sound in English. If you use it appropriately in unstressed syllables, your pronunciation will sound more natural.

You should note that an umlaut ([']) calls attention to the special quality of vowels before [r]. (The sound [ö] can also represent a vowel not followed by [r] as in *claw*.) You should listen carefully to native speakers to discover how these vowels actually sound.

### Stress

This guide also follows the system for marking stress used in many dictionaries for native speakers.

- (1) Stress is not marked if a word consisting of a single syllable occurs in isolation.
- (2) Where stress is marked, two levels are distinguished:
  - a bold accent ['] is placed after each syllable with primary stress,
  - a light accent [ˈ] is placed after each syllable with secondary stress.

### Syllable Boundaries

Syllable boundaries are indicated by a single space.

**NOTE:** The pronunciation used in this index is based on patterns of North American English. There has been no attempt to represent all of the varieties of North American English. Students should listen to native speakers to hear how the language actually sounds in a particular region.

- abdomen [āb/də mən] 4 14  
 above [ə būv/] 102 2  
 accelerator [āk sēl/ə rā/tər] 54 27  
 accordion [ə kōr/dē ən] 98 28  
 accountant [ə kown/tənt] 86 18  
 acorn [ā/kōrn] 63 33b  
 acorn squash [ā/kōrn skwōsh/] 7 28  
 across [ə krōs/] 103 6  
 actor [āk/tər] 99 19  
 actress [āk/trəs] 99 20  
 acute angle [ə kyōōt/ āng/gəl] 61 8  
 address [ā/drēs] 50 11  
 adjectives [āj/ik tīvz] 24, 26  
 aerial tramway [ēr/ē əl trām/wā]  
 57 31  
 aerosol can [ēr/ə sāl kən] 13 24  
 Africa [ā/frī kə] 72 4  
 after-shave lotion [āf/tər shāv lō/shən]  
 23 21  
 ailments [āl/mənts] 44  
 air conditioner [ēr/ kən dī/shə nər]  
 34 11  
 air filter [ēr/ fīl/tər] 55 52  
 air mattress [ēr/ mā/trəs] 91 26  
 air pump [ēr/ pūmp/] 53 12  
 air travel [ēr/ trā/vəl] 58  
 aircraft [ēr/krāft/] 52  
 (airmail) envelope [ēr/māl ɛn/və lōp]  
 50 16  
 airplane (jet) [ēr/plān (jēt)] 52 4  
 airport check-in [ēr/pōrt chēk/īn] 58  
 aisle [i/əl] 14 10, 58 23  
 alarm clock [ə lārm/ klōk] 34 8  
 Alberta [āl būr tə] 74 2  
 alcohol [āl/kə hōl/] 43 22  
 alderperson [ōl/dər pūr/sən] 78 14  
 alligator [āl/ə gā/tər] 67 8  
 almond(s) [ō/mənd(z)] 9 31  
 Alps [ālps] 73 44  
 Amazon River [a/mə zōn rīv/ər]  
 73 59  
 ambulance [ām/byə ləns] 46 13  
 amphibians [ām fī/bē ənz] 67  
 Andes [ān/dēz] 73 43  
 animals [ān/ə məlz] 64-71  
 ankle [āng/kəl] 5 49  
 announcer [ə nown/sər] 86 9  
 ant [ānt] 65 12  
 Antarctic Ocean [ānt ärk/tik o/shən]  
 72 14  
 Antarctica [ānt ärk/tī kə] 72 7  
 ant eater [ānt/ē tər] 68 5  
 antenna [ān tēn/ə] 55 46, 64 1b  
 antler [ānt/lər] 69 35a  
 apartment building  
 [ə pärt/mənt bīl/dīng] 28 1, 49 23  
 apex [ā/pēks] 61 21  
 Appalachian Mountains  
 [āp/ə lā/chē ən mown/tənz] 73 41  
 apple [ā/pəl] 8 2  
 apricot [āp/rə kōt/] 9 25  
 apron [ā/prən] 16 6  
 aquatic mammals  
 [ə kwō/tik mǎ/məlz] 70  
 Arabian Sea [ə rā/bē ən sē/] 72 30  
 arc [ärk] 61 16  
 architect [är/kə tēkt/] 86 8  
 Arctic [ärk/tik] 72 8  
 arm [ärm] 4 6, 100 20  
 armadillo [är/mə dīl/ō] 68 2  
 armpit [ärm/pīt/] 4 10  
 armrest [ärm/rēst/] 54 3  
 around [ə rownd/] 103 2  
 artery [är/tə rē] 5 69  
 artichoke [är/tə chōk/] 6 11  
 artist [är/təst] 86 3  
 arts [ärts] 86  
 ashtray [āsh/trā/] 16 29  
 Asia [a/zhə] 72 5  
 asparagus [ə spār/ə gəs] 6 18  
 asteroid [ās/tə royd/] 79 20  
 astronaut [ās/trə nōt/] 79 31  
 at [āt] 102 1  
 Atacama Desert [āt/ə kō/mə dēz/ərt]  
 73 50  
 athletic supporter  
 [āth lē/tik sə pör/tər] 22 4  
 atlas [āt/ləs] 51 20  
 attachments [ə täch/mənts] 37 17  
 attendant [ə tēn/dənt] 53 11  
 audience [ō/dē əns] 99 15  
 audio [ō/dē ō/] 100  
 aunt [ānt] 3 6  
 Australia [ō strāl/yə] 72 6  
 author [ō/thər] 51 8  
 avocado [āv/ə kō/dō] 9 33  
 away from [ə wā/ früm] 103 5  
 axe [äks] 46 8  
 baboon [bā bōōn/] 71 19  
 baby [bā/bē] 2 5  
 baby carriage [bā/bē kār/ij] 49 27  
 baby lotion [bā/bē lō/shən] 35 6  
 baby powder [bā/bē pow/dər] 35 7  
 baby wipes [bā/bē wīps/] 35 8  
 baby's room [ba/bez rōōm/] 35  
 back [bāk] 4 11, 23 19  
 backache [bāk/āk/] 44 8  
 backboard [bāk/bōrd] 92 20  
 backhoe [bāk/hō/] 82 26  
 backpack [bāk/pāk/] 19 4  
 backseat [bāk/sēt/] 54 32  
 backup light [bāk/əp lit/] 54 30  
 backyard [bāk/yärd/] 29  
 bacon [bā/kən] 10 11, 18 33  
 badge [bāj] 47 5  
 Baffin Bay [bāf/ən bā/] 72 16  
 bag [bäg] 12 8, 15 25, 21 35  
 baggage [bäg/ij] 58 8  
 bake [bāk] 33 14  
 baked beans [bākt/ bēnz/] 18 3  
 baked goods [bākt/gōōdz/] 14 11  
 baked potato [bākt/ pə tā/tō] 18 20  
 baker [bā/kər] 84 8  
 bakery [bā/kə rē] 48 6  
 balance beam [bāl/əns bēm/] 94 24  
 balcony [bāl/kə nē] 99 14  
 (bale of) hay [bal/ əv hā/] 81 13  
 ball [böl] 5 52  
 ballet [bā lā/] 99  
 ballot [bā/lət] 78 17  
 ballpoint pen [böl/poynt pēn/] 59 22  
 Baltic Sea [böl/tik sē/] 72 22  
 bananas [bə nā/nəz] 9 20  
 Band-Aid™ [bänd/ ād/] 43 4  
 band shell [bänd/ shēl/] 87 2  
 bandage [bän/dij/] 43 24  
 banister [bän/ə stər] 30 11  
 banjo [bän/jō/] 98 5  
 banking [bāng/kīng] 86  
 bar [bär] 13 18, 16 24, 56 8  
 bar stool [bär/ stōōl/] 16 25  
 barber [bär/bər] 84 3  
 Barents Sea [bär/ənts sē/] 72 23  
 bark [bärk] 63 35c

- barn [bärn] 81 5  
 barnyard [bärn/yärd/] 81 8  
 barricade [bär/ə käd/] 82 21  
 bartender [bär/tən/där] 16 21  
 base [bäs] 61 7, 93 6  
 baseball [bäs/böl/] 92  
 baseball diamond [bäs/böl/di/mənd] 93  
 baseline [bäs/līn/] 95 4  
 basin [bäs/sən] 43 16  
 basket [bäs/kət] 92 21  
 basketball [bäs/kət böl/] 92 22  
 bass [bäs] 98 10  
 bass guitarist [bäs/gə tär/əst] 99 23  
 bassoon [bäs/sōn/] 98 14  
 bat [bät] 68 4, 92 5  
 batboy [bät/boy/] 93 18  
 bath mat [bäth/mät/] 36 12  
 bath towel [bäth/tow/əl] 36 24  
 bathing suit [bä/dhīng sōt/] 90 18  
 bathing trunks [bä/dhīng trūngks/] 91 33  
 bathrobe [bäth/rōb] 22 20  
 bathroom [bäth/rōm/] 36  
 bathtub [bäth/tüb/] 36 11  
 baton [bə tōn/] 99 9  
 batter [bät/ər] 92 7, 93 14  
 battery [bät/ə rē] 55 54  
 batting helmet [bät/īng hēl/mət] 92 6  
 Bay of Bengal [bä/əv bēn göl/] 72 32  
 bays [bāz] 72  
 beach [bēch] 90  
 beach ball [bēch/böl/] 90 11  
 beach chair [bēch/chēr/] 90 20  
 beach towel [bēch/tow/əl] 90 15  
 beach umbrella [bēch/əm brēl/ə] 90 21  
 beads [bēdz] 23 7  
 beak [bēk] 66 3a  
 beard [bīrd] 4 39  
 bears [bērz] 71  
 beat [bēt] 33 8  
 Beaufort Sea [bō/fərt sē/] 72 15  
 beaver [bē/vər] 68 12, 75 3  
 bed [bēd] 34 21  
 bed rest [bēd/rēst/] 45 1  
 bedroom [bēd/rōm] 34  
 bedspread [bēd/sprēd/] 34 23  
 bee [bē] 65 19  
 beef [bēf] 10 1  
 beef stew [bēf/stōō/] 18 14  
 beer [bīr] 16 23  
 beet(s) [bēt(s)] 7 33  
 beetle [bē/təl] 65 10  
 behind [bə hīnd/] 102 9  
 below [bə lō/] 102 3  
 belt [bēlt] 20 16  
 bench [bēnch] 47 16, 48 14, 87 10  
 beret [bə rā/] 19 22  
 Bering Sea [bēr/īng se/] 72 34  
 berries [bēr/ēz] 8  
 between [bə twēn/] 102 4  
 beverages [bēv/rə jəz] 14 14  
 bib [bīb] 35 20  
 bicycle [bī/sī kəl] 52 16  
 big [bīg] 24 8  
 (Big Dipper) constellation [bīg/di/pər kōn stə lā/shən] 79 3  
 big toe [bīg/tō/] 5 53  
 biker [bī/kər] 90 4  
 bikes [bīks] 52  
 (bikini) panties [bə kē/nē pän/tēz] 22 11  
 bill [bīl] 66 24a  
 bills [bīlz] 75 5  
 bin [bīn] 15 16  
 binding [bīn/dīng] 95 16  
 binoculars [bə nōk/yə lərs] 90 7  
 birch [bürch] 63 32  
 birds [bürdz] 66  
 biscuit [bīs/kət] 18 27  
 bison [bī/sən] 69 19  
 bit [bīt] 39 43a  
 black bean(s) [blāk/bēn(z)/] 6 14  
 black bear [blāk/bēr/] 71 21  
 black eye [blāk/ī/] 44 5  
 Black Sea [blāk/sē/] 72 26  
 blackberries [blāk/bēr/ēz] 8 12  
 bladder [blä/där] 5 72  
 blade [blād] 94 27  
 blanket [bläng/ket] 34 20  
 blazer [blā/zer] 20 2  
 bleach [blēch] 25 8  
 bleaching [blēch/īng] 25 18  
 blender [blēn/där] 32 12  
 blimp [blīmp] 52 2  
 blinds [blīndz] 34 12  
 block [blök] 35 32  
 blouse [blows] 21 34  
 blue jay [blōō/jā/] 66 8  
 (blue) jeans [blōō/jēnz/] 19 6  
 blue line [blōō/līn] 93 25  
 blueberries [blōō/bēr/ēz] 8 14  
 blueprints [blōō/prīnts/] 82 6  
 blush [blūsh] 23 32  
 board [bōrd] 82 16  
 boarding [bör/dīng] 58  
 boarding pass [bör/dīng päs/] 58 18  
 boards [bōrdz] 93 24  
 boardwalk [bōrd/wök] 90 1  
 boats [böts] 52  
 body [bö/dē] 4  
 boil [boyl] 33 16  
 bolt [bōlt] 39 38  
 bongos [böng/gōz] 98 22  
 book [böök] 13 17  
 (book of) matches [böök/əv ma/chəz] 16 28  
 bookcase [böök/kās] 30 22, 83 20  
 bookstore [böök/stör] 49 18  
 booth [bōōth] 16 9  
 boots [bōōts] 19 21, 21 32  
 bottle [böt/əl] 12 3, 35 17  
 bottle opener [böt/əl ɔ/pə nər] 32 6  
 bounce [bowns] 97 11  
 bow [bō] 98 7a  
 bowl [bōl] 13 23  
 bowling [bōl/īng] 94  
 bowling ball [bōl/īng böl/] 94 6  
 box [böks] 13 12  
 box seat [böks/sēt/] 99 11  
 box spring [böks/sprīng/] 34 18  
 boxer shorts [böks/sər shōrts/] 22 2  
 boxing [böks/sīng] 94  
 boy [boy] 2 8  
 bra(ssiere) [brō]/[brə zīr/] 22 13  
 brace [brās] 38 9  
 bracelet [brās/lət] 23 9  
 brain [brān] 5 57  
 brake [brāk] 54 26  
 brake light [brāk/līt/] 54 29  
 branch [brānch] 63 35a

- brass [brās] 98  
bread [brəd] 14 12  
bread and butter plate  
  [brəd/ænd bʊt/ər plāt/] 31 11  
break [brāk] 33 7  
breast [brɛst] 11 21  
bricks [brɪks] 82 12  
bridle path [brɪd/əl pāth/] 87 7  
briefcase [brɛf/kās/] 21 37  
briefs [brɛfs] 22 12  
British Columbia  
  kə ləm bē ə] 74 1  
broccoli [brɒk/ə lɛ] 6 2  
broil [brɔɪl] 33 13  
broiler [brɔɪ/lər] 32 33  
broken bone [brɒ/kən bɒn/] 44 15  
broken lock [brɒ/kən lɒk] 40 8  
broken steps [brɒ/kən stɛps] 41 9  
broken window [brɒ/kən wɪn/dɔ]  
  40 3  
broom [brʊm] 37 7, 92 17  
brother [brʊð/ər] 3 9  
brother-in-law [brʊð/ər ən lɔ/] 3 11  
bruise [brʊz] 44 17  
brush [brʊʃ] 59 18  
brussels sprouts [brʊs/əl sprɔʊts/]  
  6 4  
bucket [bʊk/ət] 37 15  
bucket seat [bʊk/ət sɛt/] 54 16  
buckle [bʊk/əl] 20 17  
bud [bʊd] 62 18a  
buffet [bʌ fā/] 31 29  
builder [bɪl/dər] 82 5  
building number [bɪl/dɪŋ nʊm/bər]  
  49 24  
bulb [bʊlb] 62 8a  
bull [bʊl] 69 34  
bulldozer [bʊl/dɔ/zər] 82 27  
bulletin board [bʊl/ɪ tən bɔrd/]  
  59 7  
bumper [bʊm/pər] 35 5  
bun [bʊn] 18 7  
bunch [bʊnʃ] 8 1  
bungalow [bʊŋg ə lɔ] 28 6  
bureau [byʊr/ə] 34 9  
burn [bɜrn] 17 14, 44 18  
burner [bɜr/nər] 32 29  
bus [bʊs] 53 19, 55  
bus driver [bʊs/ drɪ/vər] 56 3  
bus stop [bʊs/ stɒp/] 48 13  
busboy [bʊs/boɪ/] 16 3  
bushes [bʊʃ/əz] 63 41  
business workers [biz/nəs wɜr/kərz] 86  
butcher [bʊtʃ/ər] 84 13  
butter [bʊt/ər] 18 18  
buttercup [bʊt/ər kʊp/] 62 17  
butterfly [bʊt/ər flɪ/] 65 3  
buttocks [bʊt/əks] 4 15  
button [bʊt/ən] 20 3, 101 9  
buttonhole [bʊt/ən hɔl/] 101 8  
C-clamp [sɛ/ klæmp/] 38 2  
cab driver [kæb/ drɪ/vər] 57 26  
cabbage [kæb/ɪj] 6 3  
cabin [kæb/ɪn] 58 19  
cabinet [kæb/ət nət] 32 22  
cable car [kæ/bəl kær/] 57 32  
cactus [kæk/təs] 63 40  
calculator [kæl/kyə lā/tər]  
  83 19, 100 34  
calendar [kæl/ən dər] 83 9  
calf [kæf] 4 20, 69 31  
call number [kɔl/ nʊm/bər] 51 7  
camel [kæm/əl] 69 33  
camera [kæm/ər ə] 100 8  
cameraperson [kæm/ər ə pɜr/sən]  
  86 10  
camisole [kæm/ə sɔl] 22 9  
camp stove [kæmp/ stɔv/] 89 25  
camper [kæm/pər] 53 15  
campfire [kæmp/fɪr/] 89 31  
camping [kæm/pɪŋ] 89  
can [kæn] 12 10  
can opener [kæn/ ɔ/pə nər] 32 4  
Canada arm [kæn/ə də ärm] 79 30  
Canadian emblems  
  [kə nɛ/de ən em/bləmz] 75  
canary [kə nɛr/ɛ] 66 14  
candidate [kæn/də dæt] 78 19  
candle [kæn/dəl] 31 27  
candlestick [kæn/dəl stɪk/] 31 28  
canister [kæn/ə stər] 32 15  
canned goods [kænd/ gʊdz/]  
  14 13  
cantaloupe [kæn/tə lɒp/] 9 36  
canyon [kæn/yən] 88 3  
cap [kæp] 19 2, 21 43, 92 11  
capital city [kæ/pə təl sɪt/ɛ] 74  
capsule [kæp/səl] 45 5  
car [kær] 56 9  
car interior [kær ɪn tɪr/ɛ ər] 54  
card catalogue [kærd/ kæt/ə lɔg] 51 4  
cardigan [kær/dɪ gən] 21 26  
cardinal [kærd/nəl] 66 11  
Caribbean Sea [kær/ə bɛ/ən sɛ/]  
  72 20  
carpenter [kær/pən tər] 85 2  
carpenter's rule [kær/pən tərz rʊl/]  
  38 1  
carrot(s) [kær/ət(s)] 7 32  
carry [kær/ɛ] 27 16  
carry-on bag [kær/ɛ ən bæg/] 58 2  
cars [kærz] 54–55  
carton [kær/tən] 12 1  
cartridge needle [kær/trɪj nɛ/dəl]  
  100 19  
carve [kærv] 33 6  
cash register [kæʃ/ rɛ/jə stər]  
  15 21, 25 16  
cashew(s) [kæʃ/ʊ(z)] 9 27  
cashier [kæ ʃɪr/] 15 22  
Caspian Sea [kæs/pɛ ən sɛ/] 72 27  
casserole dish [kæs/ə rɔl dɪʃ/] 32 14  
cassette [kə sɛt/] 100 26  
cassette deck [kə sɛt/ dɛk/] 100 22  
cast [kæst] 43 5  
cat [kæt] 70 4  
catch [kæʃ] 96 4  
catcher [kæʃ/ər] 92 2, 93 16  
catcher's mask [kæʃ/ərz mæsk/]  
  92 3  
catcher's mitt [kæʃ/ərz mɪt/] 92 4  
caterpillar [kæt/ər pɪl/ər] 65 1  
cattle 81 20  
Caucasus [kɔ/kə səs] 73 45  
cauliflower [kɔl/ə flɔw/ər] 6 1  
caution [kɔ/shən] 37 27  
ceiling [sɛ/lɪŋ] 30 2  
ceiling fan [sɛ/lɪŋ fæn/] 30 1  
celery [sɛl/ə rɛ] 6 10  
cello [ʃɛl/ə] 98 9  
cement [sə mɛnt/] 82 10  
cement mixer [sə mɛnt/ mɪk/sər]  
  82 25  
cent [sɛnt] 75 12



- centipede [sɛn/ˈtəpɛd/] 65 22  
 centre [sɛn/ˈtɜr] 61 13  
 centre divider [sɛn/ˈtɜr dəvɪˈdər]  
 53 17, 82 24  
 centre fielder [sɛn/ˈtɜr fɛlˈdər] 93 2  
 centre lane [sɛn/ˈtɜr lɑn/] 53 6  
 centre player [sɛn/ˈtɜr plɑˈyər] 93 30  
 chain [tʃæn] 23 5  
 chair [tʃɛr] 31 17  
 chalk [tʃɔk] 59 10  
 chalk tray [tʃɔk/ˈtrɑː] 59 9  
 chalkboard [tʃɔk/ˈbɔrd/] 59 5  
 chandelier [ʃɑnˈdælɪr/] 31 3  
 change [tʃɑnj] 75 6  
 change (the sheets)  
 [tʃɑnj/ˈdʒəʃiːts/] 42 13  
 change machine [tʃɑnj/ˈmɑːʃɪn/] 25 13  
 changing table [tʃɑn/ˈdʒɪŋtɑːbəl]  
 35 9  
 charcoal briquettes  
 [tʃɑr/ˈkɔːlbrɪˈkeɪts/] 29 23  
 chart [tʃɑrt] 43 10  
 check [tʃɛk] 16 14  
 checked [tʃɛkt] 24 18  
 checkout counter  
 [tʃɛk/ˈoʊtkəʊntər/] 15 26  
 checkout desk [tʃɛk/ˈoʊtdɛsk/]  
 51 2  
 cheek [tʃɛk] 4 35  
 cheque [tʃɛk] 15 27, 75 14  
 cherries [tʃɛr/ˈɛz] 9 19  
 cherry picker [tʃɛr/ˈɛpɪkər/] 82 18  
 chest [tʃɛst] 4 12  
 chest of drawers [tʃɛst/ˈɔvdrɔːz/]  
 34 30  
 chesterfield [tʃɛstɪrˈfɛld] 30 25  
 chestnut(s) [tʃɛst/ˈnʌt(s)] 9 32  
 chick [tʃɪk] 66 22  
 chicken [tʃɪk/ˈɛn] 11 24, 66 23  
 child's seat [tʃɪldz/ˈsiːt/] 54 33  
 children [tʃɪl/ˈdrɛn] 2 7  
 chills [tʃɪlz] 44 4  
 chimney [tʃɪm/ˈniː] 29 9  
 chimpanzee [tʃɪmˈpæn/ˈziː] 71 16  
 chin [tʃɪn] 4 3  
 china [tʃɪ/ˈnɑː] 31 1  
 china cabinet [tʃɪ/ˈnɑːkæb/ˈɛnət] 31 2  
 chipmunk [tʃɪp/ˈmʌŋk] 68 6  
 chips [tʃɪps] 18 28  
 chop [tʃɔp] 27 11, 33 11  
 chops [tʃɔps] 10 9, 10 15  
 chorus [kɔr/ˈɔs] 99 18  
 (chrysanthemum)  
 [krəˈsɑn/ˈθəˌməm]/[mʌm] 62 4  
 cigarette [sɪg/ˈəret/] 16 31  
 circle [sɪr/ˈkəl] 61 11  
 circuit breaker [sɪr/ˈkætbrɛkər/]  
 37 5  
 circular saw [sɪr/ˈkyələrsə/] 38 20  
 circumference [sɪr/ˈkʌmfərəns/]  
 61 17  
 citrus fruits [sɪ/ˈtrɛsfrʊɪts/] 8  
 city [sɪt/ˈiː] 48–49  
 city hall [sɪt/ˈɛhɔl] 78 12  
 clam(s) [kləm(z)] 11 32  
 clarinet [klɑr/ˈɛnɛt/] 98 16  
 clasp [klɑsp] 23 17  
 classroom [klɑs/ˈrʊm/] 59  
 claw [klɔ] 64 13a, 70 2a  
 clean [klɛn] 24 6, 27 2  
 cleanser [klɛn/ˈzɜr] 37 9  
 clear [klɪr] 17 6  
 cliff [klɪf] 89 21  
 clip-on earring [klɪp/ˈɔnɪr/ɪŋ/]  
 23 15  
 clock [klɔk] 59 2  
 clogged drain [klɔgdɹɛn] 41 11  
 close (v) [klɔz] 60 5  
 closed [klɔzd] 24 16  
 closet [klɔz/ˈət] 34 3  
 cloth diaper [klɔθ/ˈdiːpər/] 35 13  
 clothes [klɔz] 19–25  
 clothes line [klɔz/ˈliːn/] 37 21  
 clothes pins [klɔz/ˈpiːnz/] 37 22  
 clothes rack [klɔz/ˈræk] 25 14  
 cloudy [klaʊ/ˈdɛ] 26 2  
 clove [klɔv] 7 25a  
 cloverleaf [klɔvərˈlɛf] 53 4  
 clubs [klʌbz] 95 5  
 clutch [klʌtʃ] 54 25  
 coal [kɔl] 80 7  
 coal mine [kɔl/ˈmiːn] 80 6  
 coaster [kɔ/ˈstɔr] 16 27  
 coat [kɔt] 19 24, 46 10  
 coat of arms [kɔt/ˈɔvɑːrmz] 75 2  
 cob [kɔb] 6 12a  
 cobra [kɔ/ˈbrɑː] 67 11  
 cockpit [kɔk/ˈpɪt/] 58 13  
 (cock)roaches [kɔk/ˈrɔʃ/əz/]  
 41 13, 65 9  
 cocktail lounge [kɔk/ˈtɔːlɒnʃ/]  
 16  
 cocktail waitress [kɔk/ˈtɔːlwɛɪtrəs/]  
 16 32  
 coconut [kɔ/ˈkɔːnʌt/] 8 3  
 cocoon [kəˈkʊn/] 65 2  
 coffee [kɔ/ˈfɛ] 18 35  
 coffeemaker [kɔ/ˈfɛmɛkər/]  
 32 31  
 coffee table [kɔ/ˈfɛtɑːbəl/]  
 30 26  
 coffeepot [kɔ/ˈfɛpɔt/]  
 31 18  
 coin slide [kɔɪnslɪd] 25 2  
 coin slot [kɔɪnslɔt] 25 4  
 coins [kɔɪnz] 75 6  
 colander [kɔl/ˈændər/]  
 32 7  
 cold [kɔld] 26 10, 44 11  
 cold water faucet  
 [kɔld/ˈwɔːtərˈfəʊsət/]  
 36 18  
 collar [kɔl/ˈɛr/]  
 20 20  
 colonial-style house  
 [kəˈlɔːnɪəlstɪlˈhaʊs/]  
 29  
 column [kɔl/ˈəm/]  
 54 13  
 comb [kɔm] 34 6  
 combine [kɔm/ˈbiːn/]  
 81 17  
 comet [kɔm/ˈət/]  
 79 2  
 comforter [kʌm/ˈfɜːtər/]  
 34 22  
 commuter [kəˈmyʊt/ˈtɜr/]  
 commuter train [kəˈmyʊt/ˈtɜrˈtrɛn/]  
 57 14  
 compact disc (CD)  
 [kɔm/ˈpæktˈdɪsk/]/[sɛ/ˈdɛ/]  
 100 27  
 compact disc player  
 [kɔm/ˈpæktˈdɪsk/ˈplɛɪər/]  
 100 28  
 computer  
 [kəmˈpyʊt/ˈtɜr/]  
 59 8, 83 16, 100  
 computer programmer  
 [kəmˈpyʊt/ˈtɜrˈprɒˈgræmər/]  
 86 16  
 condominium [kənˈdɔːmɪˈniːəm/]  
 28 2  
 conductor [kənˈdʌk/ˈtɜr/]  
 56 7, 99 8  
 cone [kɔn] 61 28, 63 34b, 82 19  
 conga [kɔŋg/ˈgɑː/]  
 98 20  
 Congo River [kɔŋg/ˈgɔːrɪv/ər/]  
 73 62

- conservation officer  
[kɒn sər vāʹshən ɔʹfɪ sər] 88 5
- constellation [kɒnʹstə lāʹshən] 79 3
- construction [kən strūkʹshən] 82  
(construction) boots  
[kən strūkʹshən bōōtsʹ] 21 32
- construction site  
[kən strūkʹshən sītʹ] 82
- construction worker  
[kən strūkʹshən wūrʹkər] 82 14
- container [kən tāʹnər] 12 2
- containers [kən tāʹnərz] 12
- continents [kɒnʹtə nənts] 72
- controlled access highway  
[kən trōldʹ aksēs hīʹwā] 53 1
- conveyor belt [kən vāʹər bēlt]  
15 23, 58 12
- cook (n) [kōōk] 16 1
- cook (v) [kōōk] 17 4
- cookie [kōōkʹē] 18 22
- cool [kōōl] 26 9
- cooler [kōōʹlər] 91 41
- cooling tower [kōōʹlɪŋg tōwʹər]  
80 16
- copilot [kōʹpɪ lət] 58 16
- cord [kōrd] 34 26a, 56 1
- (corduroy) pants [kōrʹdə roy pāntsʹ]  
21 27
- core [kōr] 8 2b, 80 14
- cork [kōrk] 16 18
- corkscrew [kōrkʹskrōōʹ] 16 17
- corn [kōrn] 6 12, 62 24
- corner [kōrʹnər] 48 3
- corral [kə rālʹ] 81 24
- corrosive [kə rōʹsɪv] 37 30
- cosmetics [kōz mētʹɪks] 23
- cotton balls [kōtʹən bōlzʹ] 43 23
- cotton swab [kōtʹən swōbʹ] 35 10
- couch [kōwch] 30 25
- counter [kownʹtər] 32 27
- courier [koorʹēər] 50 23
- court [kōrt] 47, 94 13
- court officer [kōrtʹɔʹfə sər] 47 19
- court reporter [kōrtʹ rə pōrʹtər]  
47 14
- cousin [kūzʹən] 3 7
- cow [kow] 69 32
- cowboy [kōwʹboɪ] 81 21
- cowgirl [kōwʹgūrʹl] 81 22
- crab(s) [krāb(z)] 11 36, 64 9
- cracked ceiling [krāktʹ sēʹlɪŋ] 40 4
- cracked wall [krāktʹ wōl] 40 2
- cradle [krāʹdəl] 35 26
- cranberries [krānʹbērʹēz] 8 13
- creamier [krēʹmər] 31 24
- credit card [kredʹɪt kārɔd] 75 13
- (crewneck) sweater  
[krōōʹnēk swētʹər] 19 7
- crib [krīb] 35 4
- cricket [krɪkʹət] 65 5
- crime [krīm] 47
- crochet [krō shāʹ] 101 28
- crochet hook [krō shāʹ hōōkʹ]  
101 29
- crocus [krōʹkəs] 62 9
- cross-country skiing  
[krōsʹkūn trē skēʹɪŋ] 94
- crosswalk [krōsʹwōkʹ] 48 4
- crow [krō] 66 3
- crown attorney [krōwnʹ ə tūrʹnē]  
47 17
- cruise ship [krüz shīp] 52 10
- crutch [krūch] 43 7
- cube [kyōōb] 61 27
- cubicle [kyōōʹbə kəl] 83 5
- cucumber(s) [kyōōʹkūm bər(z)]  
7 20
- cuff links [kūfʹ lɪŋksʹ] 23 12
- cup [kūp] 13 19, 31 20
- cupboard [kəbʹərd] 31 2, 32 22
- curb [kūrɔb] 49 26
- curling [kūr lɪŋ] 92
- curtain [kūrʹtən] 34 10, 99 1
- curtain rings [kūrʹtən rɪŋgzʹ] 36 2
- curtain rod [kūrʹtən rōdʹ] 36 1
- curve [kūrɔv] 61 3
- cushion [kōōshʹən] 30 24
- customer [kūsʹtə mər] 15 17
- cut (n) [kūt] 44 16
- cut (v) [kūt] 33 9
- cutting board [kūtʹɪŋg bōrdʹ] 32 26
- cylinder [sɪlʹɪn dər] 61 26
- cymbals [sɪmʹbəlz] 98 18
- daffodil [dāfʹə dɪl] 62 8
- dairy cow [dērʹē kowʹ] 81 11
- dairy farm [dērʹē fārmʹ] 81
- dairy products [dērʹē prōdʹʊkts]  
14 4
- daisy [dāʹzē] 62 5
- dam [dām] 80 18
- dance [dāns] 99
- dancer [dānʹsər] 99 3
- danger [dānʹjər] 37 29
- dark [dārɔk] 24 10
- dashboard [dāshʹbōrdʹ] 54 19
- date [dāt] 9 23
- daughter [dōʹtər] 3 15
- deck [dēk] 29 5
- deer [dīr] 69 26
- defence player [də fēnsʹ plā yər]  
93 34
- defendant [də fēnʹdənt] 47 23
- defense attorney [də fēnsʹ ə tūrʹnē]  
47 22
- deli counter [dēlʹē kownʹtər] 14 1
- delivery person [də lɪvʹ ə rē pūrʹsən]  
85 10
- dental care [denʹtəl kērʹ] 43
- dental hygienist [denʹtəl hī jēnʹəst]  
43 14
- dentist [dēnʹtɪst] 43 17
- department store [də pärtʹmənt stōrʹ]  
48 5
- depth [dēpth] 61 33
- derrick [dērʹɪk] 80 2
- deserts [dēzʹərts] 73
- desk [dēsk] 30 14, 59 16, 83 13
- detective [də tēkʹtɪv] 47 2
- diagonal [dī āgʹ ə nəl] 61 20
- diameter [dī āmʹ ə tər] 61 12
- dictionary [dɪkʹshə nērʹē] 51 24
- diesel fuel [dēʹzəl fyōōʹəl] 80 34
- dig [dɪg] 27 3
- dime [dɪm] 75 10
- dining room [dīʹnɪŋ rōōmʹ] 31
- dipstick [dɪpʹstɪkʹ] 55 58
- dirty [dūrʹtē] 24 5
- disc jockey (D.J.)  
[dɪskʹ jōkʹē]/[dēʹjā] 86 9
- dish drainer [dɪshʹ drāʹnər] 32 2
- dish towel [dɪshʹ tōwʹəl] 32 18
- dishwasher [dɪshʹwōshʹər] 32 1
- dishwashing liquid [dɪshʹwōsh ɪŋg  
lɪʹkwɪd] 32 10

- disposable diaper [dɪs pəʊzə bəl dɪ'pær] 35 12  
 dive [dɪv] 97 14  
 “do not” [doo nɒt] 25 22  
 do not enter [doo nɒt ɛnt'ər] 53 32  
 doctor [dɒk'tər] 43 11  
 dogs [dɒgz] 71  
 dogwood [dɒg'wɔd] 63 28  
 doll [dɒl] 35 28  
 doll house [dɒl'həʊs] 35 25  
 dolly [dɒl'i] 58 6  
 dolphin [dɒl'fɪn] 70 13  
 donkey [dɒŋg'keɪ] 69 23  
 door handle [dɔr'hændəl] 54 4  
 door lock [dɔr'lɒk] 54 1  
 doorman [dɔr'mən] 85 11  
 down [daʊn] 103 3  
 down vest [daʊn'vest] 19 12  
 dragonfly [dræg'ɒn flɪ] 65 4  
 drain [dreɪn] 36 9  
 drainpipe [dreɪn'paɪp] 29 18  
 drapes [d্রেপs] 30 23  
 draw [drɔ] 60 11  
 drawer [dreɪ] 51 5  
 dress [dres] 20 22  
 dried fruits [draɪd'frʊts] 9  
 drill [drɪl] 43 15  
 drink [drɪŋk] 17 2  
 dripping faucet [drɪp'ɪŋ fəʊsɪt] 41 10  
 drive [draɪv] 97 15  
 driveway [draɪv'weɪ] 29 1  
 drugstore [drʉg'stɔr] 49 22  
 drum [drʉm] 98 19  
 drummer [drʉm'ər] 99 27  
 drumsticks [drʉm'stɪks] 98 19a  
 dry [draɪ] 26 14, 42 9  
 dry cleaning [draɪ'klɛn ɪŋ] 25 21  
 dryer [draɪ'ər] 25 3  
 drying [draɪ'ɪŋ] 25 19  
 duck [dʉk] 11 25, 66 25  
 (duck) pond [dʉk'pɒnd] 87 8  
 dugout [dʉg'əʊt] 93 13  
 duplex [doo'plɛks] 28 5  
 dust [dʉst] 42 15  
 dustpan [dʉst'pæn] 37 8  
 eagle [e'gəl] 66 5  
 ear [ɪr] 4 34  
 (ear of) corn [ɪr'ɒv kɔrn] 6 12  
 earmuffs [ɪr'mʉfs] 19 10  
 earrings [ɪr'ɪŋz] 23 1  
 Earth [ɜrth] 79 8, 79 13  
 east [ɛst] 73 73  
 East China Sea [ɛst'chi'nə seɪ] 72 38  
 eat [ɛt] 17 1  
 eel [ɛl] 67 4  
 egg [ɛg] 18 32, 66 13  
 egg roll [ɛg'rɒl] 18 25  
 eggplant [ɛg'plænt] 7 21  
 elastic bandage [ɪ læs'tɪk bæŋ'dɪdʒ] 44 13a  
 elbow [ɛl'bɔ] 4 8  
 electric drill [ɪ lɛk'trɪk drɪl] 39 43  
 electric guitar [ɪ lɛk'trɪk gɪ'tɑr] 99 26  
 electric generator [ɪ lɛk'trɪk ʒɛn'ərɪtər] 80 21  
 electrical tape [ɪ lɛk'trɪ kəl tæp] 39 34  
 electrician [ɪ lɛk'trɪ'shən] 85 6  
 electricity [ɪ lɛk'trɪ'sɪtɪ] 80 32  
 electronics [ɪ lɛk'trɒn'ɪks] 100  
 elephant [ɛl'əfənt] 68 17  
 elevator [ɛl'əvətər] 49 17, 80 9  
 elm [ɛlm] 63 36  
 embroidery [ɛm broɪ'də reɪ] 101 27  
 emergency brake [ɪ mʉr'ʒən se bræk] 54 15  
 emergency medical care [ɪ mʉr'ʒən se mɛd'ə kəl kɛr] 46  
 emery board [ɛm'ə re bɔrd] 23 24  
 encyclopedia [ɛn sɪ'klɒ pɛ'dɛ ə] 51 25  
 end table [ɛnd'tæbəl] 30 29  
 energy [ɛn'ərʒɪ] 80  
 engagement ring [ɛn ʒæŋ'mənt rɪŋ] 23 3  
 engine [ɛn'ʒən] 55  
 engineer [ɛn'ʒɪnɪr] 57 15  
 enter [ɛn'tər] 60 14  
 entrance ramp [ɛn'træns ræmp] 53 20  
 envelope [ɛn'vələp] 50 16, 83 31  
 equator [ɪ kwə'tɔr] 73 70  
 erase [ɪ ræs] 60 3  
 eraser [ɪ ræsər] 59 11  
 escarole [ɛs'kə rɒl] 6 7  
 esophagus [ɪ sɒf'ə ʒəs] 5 61  
 eucalyptus [yoo'kəlɪp'tʉs] 63 27  
 Europe [yoo'rɒp] 72 3  
 examining table [ɪ ʒ zæm'ə nɪŋ tæbəl] 43 6  
 exit ramp [ɛg'zɪt ræmp] 53 2  
 exit sign [ɛg'zɪt sɪn] 53 27  
 explosive [ɛk splɒ'sɪv] 37 34  
 extension cord [ɪk stɛn'shən kɔrd] 38 5  
 eye [aɪ] 5  
 eye drops [aɪ'drɒps] 45 10  
 eye irritant [aɪ'ɪr ətənt] 37 31  
 eye shadow [aɪ'shædɔ] 23 30  
 eyebrow [aɪ'braʊ] 5 44  
 eyebrow pencil [aɪ'braʊ'pɛn'səl] 23 26  
 eyelashes [aɪ'læʃ'əz] 5 46  
 eyelid [aɪ'lɪd] 5 45  
 eyeliner [aɪ'lɪ'nər] 23 33  
 fabric softener [fæb'rɪk sɒf'ə nər] 25 9  
 face [fæs] 4 1  
 face guard [fæs'gɑrd] 92 15  
 face off circle [fæs ɒf sʉr'kəl] 93 28  
 factory work [fæk'tɔ re wʉrk] 85  
 fairway [fɛr'weɪ] 95 12  
 fall (n) [fɔl] 27  
 fall (v) [fɔl] 96 7  
 family [fæm'ə leɪ] 3  
 family restaurant [fæm'ə leɪ rɛs'tər ənt] 16  
 fan belt [fæn'bɛlt] 55 53  
 fare [fɛr] 57 21  
 fare box [fɛr'bɒks] 56 5  
 farmer [fɑr'mər] 81 7  
 farmhouse [fɑrm'həʊs] 81 3  
 farming [fɑr'mɪŋ] 81  
 fashion designer [fæʃ'ən də zɪ'nər] 86 6  
 father [fɔdh'ər] 3 5  
 fawn [fɔn] 69 27  
 fax machine [fæks'məʃən] 83 32  
 feather [fɛdh'ər] 66 7a  
 feather duster [fɛdh'ər dʉs'tər] 37 2

- federal government  
[fed/ə rəl gov/ər ment] 78
- federal legislature  
[fed/ə rəl lēj/ə slā chər] 78 2
- fence [fēns] 81 9
- fever [fē/vər] 44 2
- field [fēld] 81 16
- fields and courses  
[fēldz/ ənd kōr/səz] 95
- fig [fīg] 9 21
- file cabinet [fīl/ kāb/ə nət] 83 21
- file clerk [fīl/ klürk/] 83 23
- file folder [fīl/ fōl/dər] 83 22
- filet [fī lā/] 11 28
- fill [fīl] 27 9
- film [fīlm] 100 10, 100 17
- fin [fīn] 67 3b
- finger [fīng/gər] 4 25
- finger nail [fīng/gər nāl/] 4 23
- fingerprints [fīng/gər prīnts/] 47 24
- finish line [fīn/īsh līn/] 95 21
- fire [fīr] 30 9, 46 11
- fire engine [fīr/ ēn/jən] 46 1
- fire extinguisher  
[fīr/ ik stīng/gwī shər] 46 7
- fire fighter [fīr/ fī/tər] 46 3
- fire hydrant [fīr/ hī/drənt] 46 6
- firefly [fīr/ flī/] 65 17
- fireplace [fīr/ plās/] 30 8
- fireweed [fīr/wēd] 77 12
- first baseman [fīrst/ bās/mən] 93 8
- first quarter [fīrst/ kwōr/tər] 79 23
- fish [fīsh] 11 26, 67
- fishing [fīsh/īng] 88
- fishing line [fīsh/īng līn/] 88 8
- fishing net [fīsh/īng nēt/] 88 9
- fishing rod [fīsh/īng rōd/] 88 7
- flag [flāg] 59 1, 75 1, 82 20, 95 9
- flame [flām] 31 26
- flamingo [flə mīng/gō] 66 29
- flammable [flam/ə bəl] 37 33
- flannel shirt [flān/əl shūrt/] 19 3
- flare [flēr] 55 41
- flash [flāsh] 100 7
- flashlight [flāsh/līt/] 37 3
- (flat) sheet [flāt/ shēt/] 34 19
- flight attendant  
[flīt/ ə tēn/dənt] 58 20
- flight engineer [flīt/ ēn jə nīr/] 58 17
- flipper [flīp/ər] 70 12a
- flippers [flīp/ərz] 91 36
- flooded basement [flūd/əd bās/mənt]  
41 15
- floor [flōr] 34 29
- florist [flōr/īst] 84 11
- flounder [floun/dər] 67 7
- flowers [flow/ərz] 62, 76
- flute [flōot] 98 13
- fly [flī] 65 18
- flying mammals [flī/īng mǎ/məlz]  
68
- foal [fōl] 69 22
- foggy [fōg/ē] 26 12
- fold [fōld] 25 c, 42 1
- food [fōod] 6–18
- foot [fōot] 5
- football [fōot/bōl/] 92, 92 13
- footboard [fōot bōrd] 34 24
- forearm [fōr/ārm/] 4 9
- forehead [fōr/hēd/] 4 32
- forelegs [fōr/lēgz] 68 3d
- foreman [fōr/mən] 85 13
- fork [fōrk] 31 12
- foul line [fowl/līn/] 93 9
- foundation [foun dā/shən] 82 11
- four-door hatchback [fōr/ dōr  
hāch/bāk] 55
- fox [fōks] 70 6
- fractions [frak/shənz] 61
- frame [frām] 30 4
- frame backpack [frām/ bāk/pāk] 89 28
- freezer [frē/zər] 14 3, 32 20
- freezing [frē/zīng] 26 11
- french fries [frēnch/ frīz/] 18 28
- French horn [frēnch/ hōrn/] 98 26
- fried chicken [frīd/ chīk/ən] 18 29
- Frisbee™ [frīz/bē] 90 13
- frog [frōg] 67-17
- from [früm] 103 10
- front bumper [frünt/ būm/pər] 55 51
- frozen foods [frō/zən fōodz/] 14 2
- fruit and vegetable stand  
[frōot/ ənd vēj/tə bəl stand]  
49 28
- fruit tree [frōot/ trē/] 81 2
- fruits [frōots] 8
- fry [frī] 33 15
- frying pan [frī/īng pān/] 32 5
- full moon [fōol/ mōon/] 79 24
- full slip [fōol/ slīp/] 22 10
- galaxy [gāl/ək sē] 79 1
- gallery [gāl/ə rē] 78 15
- Ganges River [gān/jēz rīv/ər] 73 67
- garage [gə rōj/] 29 2
- garbage can [gār/bīj kān/] 37 19
- garden hose [gār/dən hōs/] 29 14
- gardener [gärd/nər] 85 3
- gardenia [gär dēn/yə] 62 14
- garlic [gār/lik] 7 25
- garment bag [gär/mənt bāg/] 58 1
- garter belt [gār/tər bēlt/] 22 14
- (garter) snake [gār/tər snāk/] 67 9
- gas gauge [gās/gāj/] 54 9
- gas pump [gās/pūmp/] 53 13
- gas tank [gās/tānk/] 54 34
- gas(oline) [gās/ə lēn/] 80 28
- (gauze) bandage [göz/bān/dīj] 43 24
- gauze pads [göz/pādz/] 43 25
- gavel [gāv/əl] 47 12
- gear [gīr] 89 27
- gearshift [gīr/shīft/] 54 17
- geometrical figures  
[jē/ə mē/trī kəl fig/yərz] 61
- geyser [gī/zər] 80 5
- gibbon [gīb/ən] 71 15
- gill [gīl] 67 3c
- giraffe [jə rāf/] 69 29
- girdle [gūr/dəl] 22 15
- girl [gūrl] 2 9
- give [gīv] 17 9
- glass [glās] 13 20
- glass cleaner [glās klē/nər] 37 10
- glasses [glās/əz] 21 44
- globe [glōb] 51 19
- glove [glūv] 92 12, 94 11, 94 15
- glove compartment  
[glūv/ kəm pärt/mənt] 54 20
- gloves [glūvz] 19 1
- glue [glōo] 39 33, 59 17
- goal [gōl] 92 26
- goalie [gōl/ē] 92 25, 93 35
- goat [gōt] 69 28
- Gobi Desert [gō/bē dēz/ərt] 73 54
- golf [gōlf] 94
- golf bag [gōlf/ bāg/] 95 7
- golf ball [gōlf/ bōl/] 94 7
- golf cart [gōlf/ kärt/] 95 8

- golf course [gɔlf/ kɔrs/] 95  
golfer [gɔl/ fər] 94 10  
goose [gʊs] 66 26  
gooseberries [gʊs/ bɛr/ ɛz] 8 11  
gopher [gɔ/ fər] 68 8  
gorilla [gə rɪl/ ə] 71 17  
Governor General  
[gʊv/ ə nər jən/ ə rəl] 78 3  
grains [grānz] 62  
granddaughter [grānd/ dɔ/ tər] 2 11  
grandfather [grānd/ fɔ/ dhər] 3 2  
grandmother [grānd/ mu/ dhər] 3 1  
grandparents [grānd/ pər/ ənts] 2 10  
grandson [grānd/ sʊn/] 2 12  
grapefruit [grāp/ frʊt/] 8 7  
grapes [grāps] 8 1  
grass [grās] 29 15  
grasses [grās/ əz] 62  
grasshopper [grās/ hɔp/ ər] 65 6  
grate [grāt] 33 2  
Great Sandy Desert  
[grāt/ sən/ dɛ dɛz/ ɔrt] 73 55  
green [grɛn] 95 10  
grill [grɪl] 29 22, 88 12  
grizzly bear [grɪz/ lɛ bɛr/] 71 23  
grocer [grɔ/ sər] 84 7  
groceries [grɔ/ sə rɛz] 15 24  
ground beef [grownd/ bɛf/] 10 2  
grounding plug [grown/ dɪŋ plʊg/] 38 7  
guardsman [gɑrdz/ mən] 56 7  
guitar [gɪ tər/] 98 11  
Gulf of Alaska [gʊlf əv ə lās/ kə] 72 17  
Gulf of Guinea [gʊlf əv gɪn/ ɛ] 72 25  
Gulf of Mexico [gʊlf əv mɛk sə kɔ] 72 19  
gulfs [gʊlfs] 72  
gun [gʊn] 47 7  
gutter [gʊt/ ər] 29 10, 94 3  
gymnast [jɪm/ nɔst] 94 23  
gymnastics [jɪm nās/ tɪks] 94  
hack [hæk] 92 19  
hacksaw [hæk/ sɔ/] 38 18  
hair [hɛr] 4 30  
hair dryer [hɛr/ drɪ/ ər] 36 26  
hairbrush [hɛr/ brʊʃ/] 34 7  
hairstylist [hɛr/ drɛs/ ər] 84 10  
half (1/2) [hāf] 61 30  
half slip [hāf/ slɪp/] 22 8  
hall [hɔl] 59 12  
ham [hām] 10 12  
hamburger [hām/ bʊr/ gər] 18 9  
hammer [hām/ ər] 38 13  
hammock [hām/ ək] 29 11  
hamper [hām/ pər] 36 28  
hand [hānd] 4  
hand cart [hānd/ kɑrt/] 87 4  
hand towel [hānd/ təw/ əl] 36 23  
handball [hānd/ bɔl/] 94, 94 12  
handcuffs [hānd/ kʊfs/] 47 4  
handicrafts [hān/ dɛ krɑfts/] 101  
hang [hāŋ] 42 6  
hanger [hāŋ/ ər] 25 15, 34 2  
hard hat [hārd/ hāt/] 21 28, 82 4  
harmonica [hār mɔn/ ə kə] 98 30  
harness [hār/ nəs] 89 22  
harp [hɑrp] 98 6  
hat [hāt] 19 18  
hatchback [häch/ bæk/] 55 43  
hatchet [häch/ ət] 38 17  
hawk [hɔk] 66 7  
hay [hā] 81 13  
hazelnut(s) [hāz/ əl nʊt(s)/] 9 30  
head [hɛd] 4, 39 42a  
(head of) cauliflower  
[hɛd/ əv kɔl/ ə fləw/ ər] 6 1  
head protector [hɛd prə tɛk/ tər] 94 14  
headache [hɛd/ ək/] 44 6  
headboard [hɛd/ bɔrd/] 34 14  
headlights [hɛd/ lɪts] 55 48  
headphones [hɛd/ fɔnz] 100 29  
headrest [hɛd/ rɛst] 54 35  
headset [hɛd/ sɛt/] 83 2  
health insurance card  
[hɛlth ɪn shʊr/ əns kɑrd] 46 16  
heart [hɑrt] 5 64  
heat [hɛt] 80 27  
heating pad [hɛ/ tɪŋ pād/] 45 3  
hedge clippers [hɛj/ klɪp/ ərz] 29 29  
heel [hɛl] 5 50, 20 5  
heels [hɛlz] 20 25  
height [hɛt] 61 34  
helicopter [hɛl/ ə kɔp/ tər] 52 3  
helmet [hɛl/ mɛt] 46 9, 92 14  
hem [hɛm] 101 11  
hem binding [hɛm bɪn/ dɪŋ] 101 12  
herb(s) [ɜrb(z)] 6 9  
(herd of) cattle [hɜrd/ əv kæt/ əl] 81 20  
high [hɪ] 24 11  
high blood pressure  
[hɪ/ blʊd prɛʃ/ ər] 44 10  
high chair [hɪ/ tʃɛr/] 16 8  
(high) heels [hɪ/ hɛlz/] 20 25  
highway travel [hɪ/ wā trāv/ əl] 53  
hikers [hɪ/ kɔrz] 88 2  
hiking boots [hɪ/ kɪŋ bʊts/] 19 9  
hill [hɪl] 88 4  
Himalayas [hɪm/ ə lā/ əz] 73 47  
hind legs [hɪnd/ lɛgz/] 68 3b  
hip [hɪp] 4 16  
hippopotamus [hɪp/ ə pɔt/ ə məs] 68 14  
hit [hɪt] 96 1  
hitchhiker [hɪtʃ/ hɪ/ kər] 53 8  
hockey [hɔk/ ɛ] 93  
hockey stick [hɔk/ ɛ stɪk/] 93 21  
hog [hɔg] 69 30  
hold [hɔld] 17 12  
hole [hɔl] 94 8  
holly [hɔl/ ɛ] 63 37  
holster [hɔl/ stər] 47 8  
home plate [hɔm/ plāt/] 93 15  
honeydew melon [hʊn/ ɛ dʊw mɛl/ ən] 9 35  
hood [hʊd] 55 47  
hoof [hʊf] 69 35b  
hoofed mammals [hʊft/ mām/ əlz] 68  
hook [hʊk] 34 1, 38 16  
hook and eye [hʊk/ ənd ɪ/] 101 14  
horn [hɔrn] 54 12, 68 16a  
horse [hɔrs] 69 21  
horse racing [hɔrs/ rāsɪŋ] 94  
horse-drawn carriage  
[hɔrs/ drɔn kār/ ɪj] 57 33  
horseback rider  
[hɔrs/ bæk rɪ/ dər] 87 6  
horses [hɔrs/ əz] 81 23  
hose [hɔz] 46 4, 55 57  
hospital next exit  
[hɔs/ pɪt əl nɛkst ɛg/ zɪt] 53 26  
hot [hɔt] 26 7  
hot air balloon [hɔt/ ɛr bə lʊn/] 52 1  
hot dog [hɔt dɔg] 18 2

- hot water faucet [hōt wōt'ər fō'sət] 36 17
- house [hows] 28–29
- house plants [hows'plānts/] 63 39
- household items [hows'hōld ī'təmz] 15 15
- household services [hows'hōld sūr'və səz] 85
- housekeeper [hows'kē'pər] 85 8
- housework [hows'würk/] 42
- Huang River [hwōng'riv'ər] 73 68
- hubcap [hub'kap/] 54 36
- Hudson Bay [hūd'sən bā/] 72 18
- human body [hyōō'mən bōd'ē] 4
- hummingbird [hūm'ing bürd/] 66 2
- hump [hūmp] 69 33a
- husband [hūz'bænd] 2 3, 3 12
- hyacinth [hī'ə sīnth] 62 10
- hyena [hī'e'nə] 71 30
- hypotenuse [hī'pōt'ə nōōs/] 61 24
- ice cream cone [īs'krēm kōn/] 18 36
- ice pack [īs'pāk/] 45 4
- ice resurfacing machine (Zamboni™) [īs'rē sər'fəs īng mə shēn' (zām bō'nē)] 93 36
- ice skates [īs'skāts/] 19 15
- ice skating [īs'skāt'īng] 94
- ice tray [īs'trā] 32 21
- icing line [ī'sīng līn] 93 23
- icy [ī'sē] 26 16
- ignition [īg'nīsh'ən] 54 14
- iguana [ī'gwō'nə] 67 13
- in [īn] 102 7
- in front of [īn frūnt'əv] 102 6
- in-box [īn'bōks] 83 12
- index card [īn'dēks kārd] 51 6
- (index) finger [īn'dēks fīng'gər] 4 25
- Indian Ocean [īn'dē'ən ō'shən/] 72 13
- individual sports [īn'də vīj'ōō əl spōrts/] 94
- infection [īn fēk'shən] 44 14
- information desk [īn'fər mā'shən desk/] 51 22
- injection [īn jēk'shən] 45 8
- injuries [īn'jə rēz] 44
- insect bite [īn'sēkt bīt/] 44 3
- insects [īn'sēkts] 65
- instep [īn'stēp/] 5 51
- instruments [īn'strə mənts] 43 13, 58 14
- intercom [īnt'ər kām] 59 3
- internal organs [īn tūr'nəl ör'gənz] 5
- intersection [īn'tər sēk'shən] 48 11
- intestines [īn tēs'tənz] 5 67
- into [īn'tōō] 103 12
- iris [ī'rəs] 5 47, 62 11
- iron (n) [ī'ərn] 25 10
- iron (v) [ī'ərn] 25 d, 42 11
- ironing [ī'ər nīng] 25 20
- ironing board [ī'ər nīng bōrd/] 25 11
- jack [jāk] 34 26b, 55 38
- jacket [jak'ət] 19 17, 21 33
- jackhammer [jāk'hām'ər] 82 22
- jail [jāl] 47 1
- janitor [jān'ətər] 85 9
- jar [jār] 12 9
- jaw [jō] 4 38
- jeans [jēnz] 19 6
- jelly [jēl'ē] 18 31
- jellyfish [jēl'ē fish/] 64 12
- jet [jēt] 52 4
- jet fuel [jēt'fyōō'əl] 80 31
- jeweller [jōō'ələr] 84 12
- jewellery [jōō'əl rē] 23
- jewellery box [jōō'əl rē bōks/] 34 4
- jigsaw [jīg'sō] 38 3
- jockey [jōk'ē] 94 21
- joggers [jōg'ərs] 91 23
- jogging path [jōg'īng pāth/] 87 9
- judge [jūj] 47 10
- jukebox [jōōk'bōks/] 16 12
- jump [jūmp] 96 8
- jungle gym [jūng'əl jīm/] 87 17
- Jupiter [jōō'pə tər] 79 15
- jury [jōōr'ē] 47 21
- jury box [jōōr'ē bōks/] 47 20
- kangaroo [kāng'gə rōō/] 68 3
- Kara Sea [kār'ə sē/] 72 31
- ketchup [kēch'əp] 16 4
- kettledrum [kēt'əl drūm/] 98 21
- keyboard [kē'bōrd/] 98 1a, 100 33
- keyboard player [kē'bōrd plā'ər] 99 22
- kick [kīk] 96 3
- kickboard [kīk'bōrd] 91 27
- kidney [kīd'nē] 5 70
- kidney bean(s) [kīd'nē bēn(z)'] 6 13
- kitchen [kīch'ən] 32
- kite [kit] 91 22
- kitten [kīt'ən] 70 5
- knee [nē] 4 19
- knee socks [nē'sōks/] 22 16
- knife [nīf] 31 15
- knitting [nīt'īng] 101 22
- knitting needle [nīt'īng nē'dəl] 101 25
- knuckle [nük'əl] 4 22
- koala [kō'ōl'ə] 68 1
- label [lā'bəl] 25, 37, 50 21
- Labrador [lā'brə dōr] 74 10
- lacrosse [lə krōs'] 92
- lacrosse stick [lə krōs'stik/] 92 16
- ladder [lād'ər] 46 2, 82 8
- lady's slipper [lā'dēs slīp'ər] 77 9
- ladybug [lā'dē būg'] 65 14
- lamb [lām] 10 13, 69 24
- lamp [lāmp] 30 28
- lampshade [lāmp'shād/] 30 27
- lane [lān] 94 4
- lantern [lān'tərn] 89 29
- lapel [lə pēl'] 20 1
- Laptev Sea [lāp'tēv sē/] 72 33
- last quarter [lāst'kwōr'tər] 79 25
- laundry [lōn'drē] 25
- laundry basket [lōn'drē bās'kət] 25 6
- laundry detergent [lōn'drē də tūr'jənt] 25 7
- lawn mower [lōn'mō'ər] 29 12
- lead guitarist [lēd'gī tār'īst] 99 25
- leaf [lēf] 63 36a
- leaking ceiling [lē'kīng sē'līng] 40 1
- leaking roof [lē'kīng rōōf'] 40 1
- leave [lēv] 60 13
- left fielder [lēft'fēl'dər] 93 1
- left lane [lēft'lān'] 53 5
- left wing [lēft'wīng'] 93 32
- leg [lēg] 4 17, 10 14, 11 20
- (legal) pad [lē'gəl pād'] 83 26
- lemon [lēm'ən] 8 9
- Lena River [lē'nə riv'ər] 73 66
- length [lēngth] 61 36
- lens [lēnz] 100 6
- leopard [lēp'ərd] 70 1
- letter [lēt'ər] 50 7
- letter carrier [lēt'ər kār'yər] 50 3

- lettuce [lēt/əs] 6 6  
 level [læv/əl] 82 3  
 librarian [lī brēr/ē ən] 51 23  
 library card [lī/brēr ē kār'd/] 51 3  
 library clerk [lī/brēr ē klürk] 51 1  
 license plate [lī/səns plāt/] 54 28  
 lid [līd] 32 9  
 Lieutenant Governor  
 [lēf tē/ nənt gəv'ər nər] 78 9  
 life preserver [līf/ prə zür/vər] 90 9  
 lifeboat [līf/bōt/] 90 10  
 lifeguard [līf/gärd/] 90 6  
 lifeguard chair [līf/gärd chēr/] 90 8  
 light (*adj*) [līt] 24 9  
 light (*v*) [līt] 17 13  
 light bulbs [līt/ bəlbz/] 37 24  
 light switch [līt/ swīch/] 34 25  
 lighter [lī/tər] 16 30  
 lily [līl/ē] 62 3  
 lima bean(s) [lī/mə bēn(z)/] 6 16  
 lime [līm] 8 10  
 lines [līnz] 61  
 linesman [līnz/mən] 82 17, 93 33  
 lion [lī/ən] 70 3  
 lip [līp] 4 43  
 lipstick [līp/stīk/] 23 29  
 liquor (bottle) [līk'ər bōt/əl] 16 22  
 listen [līs/ən] 60 6  
 little finger [līt/əl fīng/gər] 4 28  
 little league baseball  
 [līt/əl lēg bās/bōl] 92  
 Little Leaguer [līt/əl lēg'ər] 92 8  
 little toe [līt/əl tō/] 5 55  
 liver [līv'ər] 5 65  
 livestock [līv/stōk/] 81 12  
 living room [līv/īng rōom/] 30  
 lizard [līz'ərd] 67 15  
 llama [lōm/ə] 68 15  
 load [lōd] 25 a  
 loaf [lōf] 12 7  
 loafer [lōf'ər] 21 42  
 lobby [lōb/ē] 48 2  
 lobster [lōb/stər] 11 30, 64 13  
 locker [lōk'ər] 59 6  
 locksmith [lōk/smīth] 85 4  
 log [lög] 30 10  
 long [lōng] 24 2  
 long johns [lōng/ jōnz/] 22 7  
 long sleeve [lōng/ slēv/] 20 15  
 loonie [lōō/nē] 75 8  
 loose [lōōs] 24 4  
 (loose-leaf) paper  
 [lōōs/ lēf pā/pər] 59 13  
 lounge chair [lownj/ chēr/] 29 24  
 low [lō] 24 12  
 luggage compartment [ləg/ij  
 kəm/pärt mənt] 58 21  
 lunar eclipse [lōō/nər ī klīps/] 79 6  
 lunch box [lunch/ bōks/] 21 31  
 lung [lūng] 5 63/
- magazine [māg/ə zēn/] 51 16  
 magnolia [māg nōl/yə] 63 29  
 mail [māl] 50 2  
 mail slot [māl/ slōt/] 50 13  
 mail truck [māl/ trūk/] 50 5  
 mailbag [māl/bāg/] 50 4  
 mailbox [māl/bōks/] 50 1, 50 6  
 maintenance [mān/tə nəns] 85  
 make (the bed) [māk/ dhə bēd/] 42 8  
 makeup [māk'üp/] 23  
 mallet [māl/īt] 38 11  
 mammals [mā/məlz] 68–71  
 man [mān] 2 2  
 manager [mān/i jər] 83 18  
 mandolin [mān/də līn/] 98 4  
 mane [mān] 69 21a  
 mango [māng/gō] 8 5  
 manhole [mān/hōl/] 49 32  
 Manitoba [mā nə tō/bə] 74 4  
 mantel [mān/təl] 30 7  
 mantis [mān/tīs] 65 7  
 manual transmission [mān/yōō əl  
 trānz mīsh/ən] 54  
 map [māp] 72  
 maple [mā/pəl] 63 38  
 maple leaf [mā/pəl lēf] 75 4  
 marigold [mār/ə gōld/] 62 6  
 Mars [mārz] 79 14  
 mascara [mā skār/ə] 23 28  
 mashed potatoes [māsh't/ pə tā/tōz]  
 18 17  
 mask [māsk] 91 35  
 mat [māt] 54 22  
 matches [māch/əz] 16 28  
 material [mə tīr/ē əl] 101 4  
 math [māth] 61  
 mattress [mā/trəs] 34 17  
 mayflower [mā/flow'ər] 77 7  
 mayor [mā'ər] 78 13  
 measurement [mēzh'ər mənt] 61  
 meat [mēt] 10  
 meatballs [mēt/bōlz/] 18 11  
 mechanic [mə kān/īk] 84 2  
 media [mē/dē ə] 86  
 medical alert bracelet  
 [mēd/ə kəl ə lert/ brās/ lət] 46 15  
 medical care [mēd/ə kəl kēr/] 43  
 medical information form  
 [mēd/ə kəl īn fər mā/shən fōrm]  
 46 17  
 medical history form  
 [mēd/ə kəl hīs/tə rē fōrm] 46 17  
 medicine [mēd/ə sən] 45  
 medicine chest  
 [mēd/ə sən chēst/] 36 14  
 Mediterranean Sea  
 [mēd/i tə rā/nē ən sē/] 72 24  
 melon [mēl/ən] 9 35  
 members of parliament  
 [mēm/bərz əv pər/lə mənt] 78 6  
 members of provincial government  
 [mēm/bərz əv prə vīn/chəl  
 gəv'ər mənt] 78 10  
 menu [mēn/yōō] 16 7  
 Mercury [mūr/kyə rē] 79 11  
 merry-go-round [mēr/ē gō rownd/]  
 87 5  
 message pad [mēs/ij pād/] 83 25  
 messenger [mēs/ən jər] 86 19  
 metal detector [mēt/əl də tēk/tər]  
 58 10  
 meteor [mē/te ər] 79 5  
 meter [mē/tər] 57 23  
 metre stick [mē/tər stīk] 59 28  
 mezzanine [mēz/ə nēn/] 99 13  
 mice [mīs] 41 14  
 microfilm [mī/krə fīlm/] 51 13  
 microfilm reader [mī/krə fīlm rē/dər]  
 51 14  
 microwave oven [mī/krə wāv ūv'ən]  
 32 23  
 middle finger [mīd/əl fīng/gər] 4 26  
 milk [mīlk] 14 5  
 Minicam™ [mīn/ē kām/] 100 2  
 mirror [mīr'ər] 34 5  
 Mississippi River [mīs/ə sīp/ē rīv'ər]  
 73 58

- mitt [mɪt] 29 20  
mittens [mɪtʰənz] 19 11  
mixed vegetables [mɪkstʰ vɛjʰtə bəlz] 18 16  
mixing bowl [mɪkʰsɪŋ bəʊlʰ] 32 24  
mobile [mōʰbəl] 35 2  
model [mōdʰəl] 86 5  
Mojave Desert [mō hōvʰē dɛzʰərt] 73 48  
money order [mūnʰē ɔrʰdər] 50  
monitor [mōnʰətər] 100 32  
monkey [mūŋgʰkē] 71 14  
monkey wrench [mūŋgʰkē rɛnʰʃ] 38 12  
monorail [mōnʰə rāʰlʰ] 57 29  
Moon [mōon] 79 9  
moose [mōos] 69 35  
mosquito [mə skēʰtō] 65 13  
motel [mōtēʰlʰ] 90 3  
moth [mōth] 65 21  
mother [mūʰdhər] 3 4  
motor oil [mōtʰər oylʰ] 80 33  
motor scooter [mōtʰər skōōʰtər] 52 14  
motorboat [mōtʰər bōtʰ] 52 12  
motorcycle [mōtʰər sɪʰkəl] 52 13, 53 18  
mountain [mōwnʰtən] 89 19  
mountain avens [mōwnʰtən əvʰənz] 76 6  
mountain climbing [mōwnʰtən klɪmʰɪŋ] 89  
mountain ranges [mōwnʰtən rānʰjəz] 73  
mountie [mōwnʰtē] 78 8  
mouse [mows] 68 9  
mousetrap [mowsʰtrəpʰ] 37 20  
mouth [mowth] 4 2  
movie camera [mōōʰvɛ kāmʰə rə] 100 15  
mow [mō] 27 6  
mum [mūm] 62 4  
municipal councillor [myōō nɪsʰə pəl kōwnʰsə lər] 78 14  
municipal government [myōō nɪsʰə pəl gəvʰər mənt] 78  
muscle [mūsʰəl] 5 62  
mushroom(s) [mūshʰrōom(z)] 7 30  
music [myōōʰzɪk] 99  
musical comedy [myōōʰzə kəl kōmʰə dē] 99  
musical instruments [myōōʰzə kəl ɪnʰstrə mənts] 98  
musician [myōō zɪshʰən] 99 10  
mussel(s) [mūsʰəl(z)] 11 34, 64 3  
mustache [mūsʰtəsh] 4 40  
mustard [mūsʰtərd] 18 1  
nail [nāl] 39 41  
nail clippers [nālʰklɪpʰərz] 23 31  
nail polish [nālʰpōʰlɪsh] 23 25  
nailbrush [nālʰbrūshʰ] 36 20  
napkin [nāpʰkɪn] 31 14  
natural gas [nāchʰər əl gāsʰ] 80 29  
neck [nɛk] 4 4  
necklace [nɛkʰlɪs] 23 6  
nectarine [nɛkʰtə rɛnʰ] 8 17  
needle [nēʰdəl] 43 26, 63 34a, 101 18  
needlecrafts [nēʰdəl krāftsʰ] 101  
needlepoint [nēʰdəl poyntʰ] 101 26  
neighbourhood parks [nāʰbər hōod pārkʰs] 87  
nephew [nɛfʰyōō] 3 13  
Neptune [nɛpʰtōon] 79 18  
nest [nɛst] 66 31  
net [nɛt] 92 24, 93 22, 95 2  
new [nōō] 24 13  
New Brunswick [nōō brənʰzwlk] 74 7  
new moon [nōōʰmōonʰ] 79 26  
Newfoundland [nōōʰfənd lənd] 74 10  
newscaster [nōōzʰkāsʰtər] 86 2  
newspaper [nōōzʰpāʰpər] 21 48  
newsstand [nōōzʰstāndʰ] 49 30  
next to [nɛkstʰtōō] 102 11  
nickel [nɪkʰəl] 75 11  
niece [nɛs] 3 14  
Niger River [nɪʰjər rɪvʰər] 73 61  
night table [nɪtʰtāʰbəl] 34 27  
nightgown [nɪtʰgownʰ] 22 21  
nightstick [nɪtʰstɪkʰ] 47 9  
Nile River [nɪlʰ rɪvʰər] 73 63  
nipple [nɪpʰəl] 35 18  
no heat [noʰ hētʰ] 40 5  
no hot water [noʰ hōtʰ wōtʰər] 40 7  
no left turn [noʰ lɛftʰ tɜrn] 53 31  
no parking (here to corner) [noʰ pārkɪŋ (hɛr tōō kōrʰnər)] 49 35  
no "U" turn [nōʰ yōō tɜrn] 49 33  
north [nōrth] 73 71  
North America [nōrthʰ ə mɛrʰə kə] 72 1  
North Atlantic [nōrthʰ ət lānʰtɪk] 72 11  
North Pacific [nōrthʰ pə sɪfʰɪk] 72 9  
North Sea [nōrthʰ sēʰ] 72 21  
Northwest Territories [nōrth westʰ tɛrʰə tōr ɛz] 74 12  
nose [nōz] 4 36  
nostril [nōsʰtrɪl] 4 37  
Nova Scotia [nōvʰə skōshʰə] 74 8  
nozzle [nōzʰəl] 46 5  
nuclear reactor [nōōʰklɛ ə rɛ əkʰtər] 80 13  
nurse [nɜrs] 43 19  
nut [nūt] 39 39  
nuts [nʌts] 9  
oak [ōk] 63 33  
oats [ōts] 62 23  
Ob River [ōbʰ rɪvʰər] 73 64  
oboe [ōʰbō] 98 15  
obtuse angle [ōb tōōsʰ əŋgʰgəl] 61 5  
occupations [ōkʰyə pāʰ shənz] 84–86  
oceans [oʰshənz] 72  
octopus [ōkʰə pəs] 64 6  
office [ōʰfɪs] 83  
office building [ōʰfɪs bɪlʰdɪŋ] 48 1  
officer [ōfʰə sər] 86 13  
oil [oyl] 42 12  
oil well [oylʰ wɛlʰ] 80 1  
ointment [oyntʰmənt] 45 9  
old [ōld] 24 14  
on [ɔn] 102 5  
on top of [ɔn tōpʰ əv] 102 10  
onion(s) [ūnʰyən(z)] 7 31  
Ontario [ɔn tɛrʰē ō] 74 5  
open [ōʰpən] 24 15, 33 3  
opposition [ōp ə zɪshʰən] 78 7  
optician [ōp tɪshʰən] 84 9  
oral hygienist [ɔrʰəl hɪ jɛʰnɪst] 43 14



- orange [ɔr/ɪnj] 8 8  
 orangutan [ə rɒŋg/ə tʌn/] 71 18  
 orbit [ɔr/bɪt] 79 21  
 orchard [ɔr/ʧɔrd] 81 1  
 orchestra [ɔr/ʧə strə] 99 6  
 orchestra seating [ɔr/ʧə strə sɛt/ɪŋg] 99 12  
 orchid [ɔr/kɪd] 62 12  
 order [ɔr/dɔr] 17 5  
 orderlies [ɔr/dɔr lɛz] 43 8  
 organ [ɔr/gən] 98 29  
 ostrich [ɔs/trɪʃ] 66 12  
 Ottawa [ɔt/ə wä] 74 13  
 otter [ɔt/ər] 70 10  
 out of [əwt/əv] 103 7  
 outer space [əwt/ər spās/] 79  
 outlet [əwt/lat] 38 6  
 oval [ə/və] 61 18  
 oven [üv/ən] 32 32  
 oven cleaner [üv/ən klɛ/nər] 37 11  
 over [ə/vər] 103 8  
 overalls [ə/vər ɔlz/] 21 30  
 overcoat [ə/vər kɔt/] 19 20  
 overhead projector [ə/vər hɛd prə jɛk/tər] 59 27  
 overhead road sign [ə/vər hɛd rɔd sɪn] 53 25  
 overpass [ə/vər pās/] 53 3  
 owl [əwl] 66 6  
 oyster(s) [ɔy/stər(z)] 11 33, 64 2  
 pacific dogwood [pə sɪf/ɪk dɔg/wɔd] 76 2  
 pacifier [päs/ə fɪ/ər] 35 22  
 pack [pæk] 13 16  
 package [pæk/ɪj] 12 4, 50 19  
 pad [pād] 83 26  
 paddle [pād/əl] 94 18  
 page [pāj] 78 11  
 pail [pāl] 37 15, 90 16  
 paint (n) [pānt] 37 26, 39 31  
 paint (v) [pānt] 27 1  
 paint thinner [pānt/ thɪn/ər] 37 25  
 paintbrush [pānt/brʊʃ/] 39 30  
 Painted Desert [pān/təd dɛz/ərt] 73 49  
 painter [pān/tər] 85 7  
 painting [pān/tɪŋg] 30 5  
 (pair of) scissors [pɛr/əv sɪz/ərz] 101 17  
 pajamas [pə jəm/əz] 22 19  
 palm [pɒm] 4 29, 63 26  
 pan [pān] 39 28  
 pancakes [pān/kāks/] 18 5  
 pancreas [pāŋg/krɛ əs] 5 71  
 panda [pān/də] 71 20  
 pansy [pān/zɛ] 62 2  
 panties [pān/tɛz] 22 11  
 pants [pānts] 21 27  
 pantyhose [pān/tɛ hɔz/] 22 5  
 papaya [pə pɪ/yə] 8 6  
 paper clips [pā/pər klɪps/] 83 28  
 paper towels [pā/pər təw/əlz] 37 23  
 parakeet [pār/ə kɛt] 66 15  
 parallel lines [pār/ə lɛl lɪnz/] 61 4  
 paramedic [pār/ə mɛd/ɪk] 46 14  
 Paraná River [pār/ə nɔ/ rɪv/ər] 73 60  
 parents [pār/ənts] 2 6  
 park [pärk] 87  
 parka [pär/kə] 19 8  
 parking garage [pär/kɪŋ gə rɔj/] 49 19  
 parking lights [pär/kɪŋ lɪts/] 55 49  
 parking meter [pär/kɪŋ mɛ/tər] 49 20  
 parliament building [pär/lə mɛnt bɪl/dɪŋg] 78 1  
 parrot [pār/ət] 66 16  
 part [pärt] 4 31  
 pass [päs] 96 5  
 passenger [päs/ɪn jər] 57 25  
 passenger car [päs/ɪn jər kār/] 53 14  
 pasture [päs/ʧər] 81 6  
 patient [pā/shənt] 43 20  
 patio [pā/tɛ ə/] 29 17  
 pattern [pāt/ərn] 101 7  
 pattern piece [pāt/ərn pɛs/] 101 6  
 paw [pö] 71 29a  
 pay [pā] 17 7  
 payphone [pā fɔn] 48 7  
 pea(s) [pɛ(z)] 6 17  
 peach [pɛʃ] 9 37  
 peacock [pɛ/kɔk/] 66 18  
 peak [pɛk] 89 20f  
 peanut(s) [pɛ/nüt(s)/] 9 28  
 pear [pɛr] 8 18  
 pedal [pɛd/əl] 43 18  
 pedestrian [pə dɛs/trɛ ən] 48 12  
 peel (n) [pɛl] 9 20a  
 peel (v) [pɛl] 33 5  
 pegboard [pɛg/bɔrd] 38 15  
 pelican [pɛl/ə kən] 66 24  
 penalty box [pɛn/əl tɛ bɔks] 93 26  
 pencil [pɛn/səl] 59 24  
 pencil eraser [pɛn/səl ə rā/sər] 59 21  
 pencil sharpener [pɛn/səl shär/pə nər] 59 20, 83 30  
 penguin [pɛn/gwɪn] 66 27  
 penny [pɛn/ɛ] 75 12  
 people [pɛ/pəl] 2  
 pepper shaker [pəp/ər shä/kər] 31 9  
 pepper(s) [pɛp/ər(z)] 7 22  
 percussion [pər kʊʃ/ən] 98  
 perfume [pür/fyoom] 23 27  
 periodicals section [pür/ɛ əd/ə kəlz sɛk/shən] 51 15  
 perpendicular lines [pür/pən dɪk/yə lər lɪnz/] 61 2  
 Persian Gulf [pür/zhən gʊlf/] 72 28  
 personal computer (PC) [pür/sə nəl kʊm pyōō/tər/] [pɛ/sɛ/] 100 31  
 petal [pɛt/əl] 62 18b  
 petunia [pə tōōn/yə] 62 7  
 pharmacist [fär/mə sɪst] 84 1  
 phases of the moon [fā/zəz əv dhə mōōn/] 79  
 pheasant [fɛz/ənt] 66 19  
 Phillips screwdriver [ɪl/ɪps skrōō/dri vər] 39 25  
 phone [fɔn] 34 26  
 photocopier [fɔ/tə kɔp/ɛ ə] 83 24  
 photocopy machine [fɔ/tə kɔp/ɛ mə shɛn/] 51 18  
 photographer [fə tɔg/rə fər] 86 4  
 photography [fə tɔg/rə fɛ] 100  
 piano [pɛ ān/ō] 98 1  
 piccolo [pɪk/ə lō/] 98 12  
 pick (v) [pɪk] 27 7  
 pick (n) [pɪk] 98 11a  
 pickax [pɪk/äks/] 82 13  
 pickle [pɪk/əl] 18 8  
 pickup truck [pɪk/ əp trük/] 52 6

- picnic area [pɪk/nɪk ɛr/ə] 88  
 picnic basket [pɪk/nɪk bɑs/kæt] 88 13  
 picnic table [pɪk/nɪk tɑ/bəl] 88 15  
 piece [pi:s] 13 22  
 pierced earring [pɪrst/ɪr/ɪŋ] 23 16  
 pigeon [pɪj/ən] 66 1  
 pill [pɪl] 45 7  
 pillow [pɪl/ə] 34 16  
 pillowcase [pɪl/ə kɑs/] 34 15  
 pilot [pɪ/lət] 58 15  
 pin [pɪn] 23 8, 94 5, 101 20  
 pincushion [pɪn/kʊʃ/ən] 101 3  
 pine [pɪn] 63 34  
 pineapple [pɪn/æp/əl] 8 4  
 ping-pong [pɪŋ/pɒŋ/] 94  
 ping-pong ball [pɪŋ/pɒŋ bɔl/] 94 19  
 pinking shears [pɪŋ/kɪŋ ʃɪr/z/] 101 5  
 pipe [pɪp] 16 26, 37 18  
 pit [pɪt] 9 37a  
 pitcher [pɪtʃ/ər] 31 4, 93 12  
 pitcher plant [pɪtʃ/ər plɑnt] 76 5  
 pitcher's mound [pɪtʃ/ərz maʊnd/] 93 11  
 pitchfork [pɪtʃ/fɔrk/] 81 14  
 pizza [pɪz/ə] 18 30  
 plaid [plæd] 24 22  
 planets [plæn/əts] 79  
 plant (v) [plɑnt] 27 4  
 plants (n) [plɑnts] 62  
 plate [plæt] 31 13  
 plateau [plə tə/] 88 1  
 platform [plæt/fɔrm/] 56 11  
 playground [plæ/graʊnd/] 87 15  
 playpen [plæ/pɛn/] 35 30  
 pliers [plɪ/ərz] 38 19  
 plug [plʊg] 39 43d  
 plum [plʊm] 9 34  
 plumber [plʊm/ər] 85 1  
 plunger [plʊn/ʃər] 37 14  
 Pluto [plʊtə] 79 19  
 pocket [pɒk/ət] 21 41  
 pod [pɒd] 6 17a  
 podium [pə/di:əm] 99 7  
 poinsettia [pɔɪn sɛt/ə] 62 15  
 poison [pɔɪ/zən] 37 32  
 poison ivy [pɔɪ/zən i/vi:] 63 45  
 poison oak [pɔɪ/zən ɔk/] 63 43  
 poison sumac [pɔɪ/zən sʊm/æk] 63 44  
 poisonous plants [pɔɪ/zə nəs plɑnts/] 63  
 polar bear [pɒl/ər bɛr/] 71 22  
 pole [pɒl] 94 34, 95 14  
 police officer [pə lɛs/ɔf/ə sər] 47 6  
 police station [pə lɛs/stɑ/shən] 47  
 polish [pɒl/ɪʃ] 42 3  
 polka dot [pɒl/kə dɔt/] 24 19  
 pond [pɒnd] 87 8  
 pony [pɒ/nɛ] 69 20  
 pop [pɒp] 16 11  
 poplar [pɒp/lər] 63 30  
 porch [pɔ:tʃ] 29 6  
 porcupine [pɔr/kyə pɪn/] 68 11  
 pork [pɔrk] 10 6  
 pork chops [pɔrk/ tʃɔps/] 18 15  
 porter [pɔr/tər] 58 5  
 post [pɒst] 23 18  
 post office [pɒst/ ɔf/ɪs] 48 9, 50  
 postal code [pɒs/təl kɔd] 50 12  
 postal worker [pɒs/təl wɜr/kər] 50 14  
 postcard [pɒst/ kɑrd/] 50 17  
 postmark [pɒst/ mɑrk/] 50 9  
 pot [pɒt] 32 13  
 pot holder [pɒt/ hɔl/dər] 32 34  
 potato chips [pə tɑ/tə tʃɪps/] 18 4  
 potato(es) [pə tɑ/tə(z)] 7 23  
 potty [pɒt/ɪ] 35 33  
 pouch [paʊtʃ] 68 3c  
 pouched mammals [paʊtʃt/ mɑ/mælz] 68  
 poultry [pɒl/trɛ] 11  
 pour [pɔr] 33 4  
 power lines [paʊ/ər lɪnz/] 80 24  
 power sander [paʊ/ər sɑn/dər] 39  
 power saw [paʊ/ər sɔ/] 29 25  
 power station [paʊ/ər stɑ/shən] 80 20  
 prairie crocus [prɛ/rɛ krɔ kəs] 76 3  
 prepositions [prɛp/ə zɪ/ shənz] 102, 103  
 primates [prɪ/mæts] 71  
 Prime Minister [prɪm mɪn/ə stər] 78 4  
 Prince Edward Island [prɪns ɛd/wɔrd i/lənd] 74 9  
 print [prɪnt] 24 21  
 printer [prɪn/tər] 83 4  
 printout [prɪnt/əʊt/] 83 8  
 prints [prɪnts] 100 11  
 priority post courier [prɪ ɔr/ət ɛ pɒst kɜr/ ɛər] 50 23  
 produce [prɒd/ʊs] 14 9  
 programs [prɒ/ɡrɑmz] 99 17  
 projector [prɒ jɛk/tər] 100 16  
 propane gas [prɒ/pæn gɑs/] 80 30  
 province [prɒv/əns] 74  
 provincial government [prə vɪn/ʃəl gəv/ər mɛnt] 78  
 provincial symbols [prə vɪn/ʃəl sɪm/bɔlz] 76-77  
 prune [prʊn] 9 22  
 public library [pʊb/lik li/brɛr ɛ] 51  
 public telephone [pʊb/lik tɛl/ə fɒn] 48 7  
 public transportation [pʊb/lik trɑns/pər tɑ/shən] 56  
 puck [pʊk] 93 20  
 pump [pʊmp] 13 14  
 pumpkin [pʊmp/kɪn] 7 26  
 punishment [pʊn/ɪʃ mɛnt] 47  
 pupil [pyʊ/ɔpəl] 5 48  
 puppy [pʊp/ɪ] 71 27  
 purple violet [pɜr/pəl vi/ə lət] 76 4  
 purse [pɜrs] 20 23  
 push [pʊʃ] 27 12  
 putter [pʊt/ər] 94 9  
 puzzle [pʊz/əl] 35 31  
 pyramid [pɪr/ə mɪd/] 61 25  
 quantities [kwɒn/tə tɛz] 12  
 quarter [kwɔr/tər] 11 18, 61 31, 75 9  
 Quebec [kə/bɛk] 74 6  
 quill [kwɪl] 68 11a  
 quilting [kwɪl/tɪŋ] 101 32  
 rabbit [ræb/ɪt] 68 13  
 raccoon [ræ kʊn/] 70 7  
 race track [ræs/ træk/] 95  
 rack [ræk] 51 17  
 racket [ræk/ɪt] 94 2  
 racquet [ræk/ɪt] 94 29  
 racquetball [ræk/ɪt bɔl/] 94, 94 30  
 radiator [ræ/di:ət/ər] 55 56

- radio [rā/dē ō'] 54 18  
 radish(es) [rād/ish(əz)] 7 29  
 radius [rā/dē əs] 61 14  
 raft [rāft] 89 16  
 rafters [rāf/tərz] 82 1  
 rafting [rāf/tīng] 89  
 rags [rāgz] 37 4  
 rain boots [rān/bōōts'] 19 25  
 raincoat [rān/kōt'] 21 38  
 rainy [rān/ē] 26 1  
 raise (one's hand) [rāz/wūnz hānd']  
 60 1  
 raisin(s) [rā/zən(z)] 9 24  
 rake (v) [rāk] 27 10  
 rake (n) [rāk] 29 30  
 ramp speed sign [rāmp/spēd sīn']  
 53 28  
 ranch [rānch] 81  
 ranch house [rānch/hows'] 29  
 ranching [rānch/īng] 81  
 rapids [rāp/īdz] 89 17  
 rash [rāsh] 44 1  
 raspberries [rāz/bēr/ēz] 8 16  
 rat [rāt] 68 7  
 rattle [rāt/əl] 35 21  
 rattlesnake [rāt/əl snāk'] 67 10  
 razor [ra/zər] 23 20  
 razor blades [ra/zər blādz'] 23 23  
 read [rēd] 60 4  
 real estate agent [rēl/ə stāt ā/jənt]  
 85 5  
 rear bumper [rīr būm/pər] 55 42  
 rearview mirror [rīr/vyōō mir/ər]  
 54 7  
 receipt [rə sēt'] 15 20, 57 24  
 receiver [rə sē/vər] 100 21  
 receptionist [rə sēp/shə nəst] 86 17  
 recliner [rə klī/nər] 30 16  
 records [rēk/ərdz] 100 23  
 rectangle [rēk/tāng/gəl] 61 19  
 recyclable [rē sī/klə bəl] 13 25  
 red line [rēd līn] 93 27  
 Red Sea [rēd/sē'] 72 29  
 redwood [rēd/wōōd'] 63 25  
 (reel of) film [rēl/əv fīlm'] 100 17  
 referee [rēf/ə rē'] 93 29, 94 16  
 reference section [rēf/ə rəns  
 sēk/shən] 51 21  
 reference slip [rēf/ə rəns slīp] 51 12  
 (reference) librarian [rēf/ə rəns  
 lī brēr/ē ən] 51 23  
 refinery [rə fī/nə rē] 80 12  
 refreshment stand [rə frēsh/mənt  
 stānd'] 90 2  
 refrigerator [rə frīj/ə ra/tər] 32 19  
 refrigerator not working [rə frīj/ə ra/tər  
 nōt wūr/king] 41 12  
 reins [rānz] 94 22  
 relationships [rə lā/shən shīps'] 2  
 remedies [rēm/ə dēz] 45  
 remote control [rə mōt/kən trōl']  
 30 17  
 repair [rə pēr'] 42 10  
 repairperson [rə pēr/pūr/sən] 84 5  
 reporter [rə pōr/tər] 86 11  
 reptiles [rēp/tīlz] 67  
 rescue [rēs/kyōō] 46  
 restaurant [rēs/tə rənt] 16  
 retriever [rə trē/vər] 71 26  
 return address [rə tūrn/ā drēs'] 50 8  
 rhinoceros [rī nōs/ə rəs] 68 16  
 rice [rīs] 62 21  
 ride [rīd] 97 14  
 rider [rī/dər] 56 6  
 right angle [rīt/āng/gəl] 61 23  
 right fielder [rīt/fēl/dər] 93 3  
 right lane [rīt/lān'] 53 7  
 right triangle [rīt/trī/āng gəl] 61 22  
 right wing [rīt wīng] 93 31  
 rind [rīnd] 8 8b  
 ring binder [rīng/bīn/dər] 59 14  
 ring finger [rīng/fīng/gər] 4 27  
 ring(s) [rīng(z)] 23 2, 79 16a, 94 17  
 rink [rīngk] 94 25  
 Rio Grande River  
 [rē/ō grānd/rīv/ər] 73 57  
 rivers [rīv/ərz] 73  
 road signs [rōd/sīnz'] 53  
 road work [rōd/würk] 82  
 roadrunner [rōd/rūn/ər] 66 32  
 roast [rōst] 10 3, 10 8  
 roasting pan [rōs tīng pān'] 32 17  
 robes [rōbz] 47 11  
 robin [rōb/īn] 66 9  
 rock [rök] 92 18  
 rock group [rök/grōōp'] 99  
 rocket [rök/ət] 79 27  
 rocking chair [rök/īng chēr'] 35 16  
 rocks [röks] 88 11  
 Rocky Mountains  
 [rök/ē mōwn/tənz] 73 40  
 rodents [rō/dənts] 68  
 roll [rōl] 12 11, 18 19  
 (roll of) film [rōl/əv fīlm'] 100 10  
 roller [rōl/ər] 39 29  
 rolling pin [rōl/īng pīn'] 32 25  
 rolodex [rōl/ə dēks'] 83 14  
 roof [rōōf] 29 4  
 rooster [rōō/stər] 66 21  
 root [rōōt] 63 35d  
 rope [rōp] 89 23  
 rose [rōz] 62 18  
 rough [rūf] 95 6  
 router [rōw/tər] 39 37  
 row [rō] 51 11, 81 18  
 Rub' al Khali Desert  
 [rōōb/āl kōl/ē dēz/ərt] 73 52  
 rubber gloves [rüb/ər glūvz] 37 13  
 rug [rüg] 34 28  
 ruler [rōō/lər] 59 23  
 run [rūn] 96 6  
 rung [rūng] 82 9  
 runner [rūn/ər] 91 23, 94 31  
 running shoes [rūn/īng shōōz] 20 11  
 saddle [sād/əl] 94 20  
 safety goggles [sāf/tē gōg/əlz] 94 28  
 safety pin [sāf/tē pīn'] 35 11  
 Sahara Desert [sə hēr/ə dēz/ərt]  
 73 51  
 sailboat [sāl/bōt'] 52 11  
 salad bowl [sāl/əd bōl'] 31 25  
 salad dressing [sāl/əd drēs/īng]  
 18 12  
 salamander [sāl/ə mən/dər] 67 14  
 salesperson [sālz/pūr/sən] 86 12  
 salt (v) [sōlt] 27 14  
 salt shaker [sōlt/shā/kər] 31 10  
 sand (n) [sānd] 91 31  
 sand (v) [sānd] 27 14  
 sand dunes [sānd/dōōnz'] 90 12  
 sand trap [sānd/trāp'] 95 11  
 sandal [sān/dəl] 20 19  
 sandbox [sānd/bōks'] 87 13  
 sandcastle [sānd/kās/əl] 91 32

- sandpaper [sænd/'pɑ:pər] 39 27  
sandwich [sænd/'wɪtʃ] 16 16  
Saskatchewan [sə skæch/'ə wən] 74 3  
satellite [sæt/'ə lit] 79 28  
Saturn [sæt/'ɜ:n] 79 16  
saucepan [sɔs/'pæn/] 32 8  
saucer [sɔ/'sɜ:] 31 21  
sausage [sɔ/'sɪ:] 10 7  
saw [sɔ] 38 8  
saxophone [sæks/'fə fən/] 98 24  
scaffolding [skæf/'əl dɪŋ] 82 7  
scale [skæl] 14 7, 36 32  
scallop(s) [skæl/'əp(s)] 11 35, 64 10  
scarecrow [skɛr/'krəʊ/] 81 19  
scarf [skɑ:rf] 19 19  
scenery [sɛ/'nɜ:ri] 99 2  
school [skʊl] 60  
scissors [sɪz/'ɜ:z] 101 17  
scoreboard [skɔr/'bɔ:rd/] 93 19  
scorpion [skɔr/'pɛ:ən] 65 8  
scouring pad [skɔwɪŋ/'pæd/] 32 11  
scrape [skræp] 27 15  
scraper [skræp/'ɜ:] 38 14  
screen [skrɛn] 29 19, 100 14  
screw [skrʊ] 39 42  
screwdriver [skrʊ/'dri:vər] 39 24  
scrub [skrʊb] 42 2  
scuba tank [skʊb/'tæŋk/] 91 37  
sea gull [si/'gʊl/] 66 4  
sea horse [si/'hɔ:s/] 67 1  
Sea of Japan [si/'ɔv jə pæn/] 72 36  
Sea of Okhotsk [si/'ɔv ɔ kɔtsk/]  
72 35  
seafood [si/'fʊd/] 70 12  
seal [si:] 70 12  
seam [si:m] 101 10  
seas [si:z] 72  
seat [si:t] 56 2  
seat belt [si:t/'bɛlt] 54 23  
second baseman [sɛk/'ənd bæs/mən]  
93 7  
secretary [sɛk/'rɜ:təri:] 83 11  
section [sɛk/'ʃən] 8 8a, 61 15  
security [sə kyʊr/'ə tɛ] 58  
security guard [sə kyʊr/'ə tɛ gɑ:rd]  
58 9, 86 14  
sedan [sə dæn/] 55  
seed [si:d] 8 8c  
seesaw [si:/sə/] 87 18  
semi-detached house [si:m i dətʃtʃ/  
'haʊs] 28 4  
serve [sɜ:v] 17 3, 96 2  
service area [sɜ:v/'vɜ:s ɛr/'e ə] 53 10  
service court [sɜ:v/'vɜ:s kɔ:rt/] 95 1  
service line [sɜ:v/'vɜ:s li:n/] 95 3  
serviette [sɜ:v vɛ 'ɛt/] 31 14  
set (the table) [set dhə tæ/'bɔ:l] 17 8  
sewing [si:'wiŋ] 101  
sewing machine [si:'wiŋ mə 'ʃi:n/]  
101 1  
shade [ʃeɪd] 35 1  
shaft [ʃæft] 80 10  
shampoo [ʃæm pʊ/'ɔ:] 36 8  
shank [ʃæŋk] 39 43b  
shark [ʃɑ:k] 67 5  
shaving cream [ʃeɪ/'viŋ kri:m/]  
23 22  
sheep [ʃi:p] 69 25, 81 10  
sheet [ʃi:t] 34 19  
sheet music [ʃi:t/'myʊzɪk] 98 2  
shelf [ʃɛlf] 14 6, 51 26  
shell [ʃɛl] 64 1a, 67 18a, 91 40  
shellfish [ʃɛl/'fi:ʃ/] 11  
shepherd [ʃɛp/'ɜ:rd] 71 28  
shield [ʃi:ld] 76  
shingle [ʃɪŋg/'gəl] 82 2  
shirt [ʃɜ:rt] 21 46  
shoe [ʃu:] 21 49  
shoelace [ʃu:'leɪs/] 20 7  
shoot [ʃu:t] 97 16  
shop worker [ʃɔp/'wɜ:kər] 85 12  
shopping bag [ʃɔp/'ɪŋ bæg/] 20 18  
shopping basket [ʃɔp/'ɪŋ bæs/kɒt]  
14 8  
shopping cart [ʃɔp/'ɪŋ kɑ:rt/] 15 19  
short [ʃɔ:rt] 24 1  
short sleeve [ʃɔ:rt/'slɛv/] 20 21  
shorts [ʃɔ:rts] 20 14  
shortstop [ʃɔ:rt/'stɒp/] 93 5  
shoulder [ʃɔl/'dɜ:] 4 5, 53 21  
(shoulder) bag [ʃɔl/'dɜ: bæg/] 21 35  
shovel (n) [ʃʊv/'əl]  
29 31, 82 15, 90 17  
shovel (v) [ʃʊv/'əl] 27 13  
shower cap [ʃəʊ/'ɜ:kæp/] 36 3  
shower curtain [ʃəʊ/'ɜ:kɜ:tən]  
36 5  
shower head [ʃəʊ/'ɜ:hɛd/] 36 4  
shrimp [ʃrɪmp] 11 31, 64 8  
shutter [ʃʊt/'ɜ:] 29 8  
shuttle car [ʃʊt/'əl kɑ:r/] 80 8  
side [saɪd] 61 10f  
side mirror [saɪd/'mɪr'ɜ:] 54 2  
sideburn [saɪd/'bɜ:rn/] 4 33  
sidewalk [saɪd/'wɔ:k/] 49 25  
Sierra Madre [si:'ɛr'ə mɔ:'drɛ] 73 42  
silo [saɪ'ləʊ] 81 4  
silverware [sɪl/'vɜ:wɛr/] 31 22  
simple animals [sɪm/'pəl ɔn/'ə mɔ:lz]  
64  
singer [sɪŋg/'ɜ:] 99 24  
sink [sɪŋk] 36 19  
sister [sɪs/'tɜ:] 3 10  
sister-in-law [sɪs/'tɜ: ən lɔ:/] 3 8  
six-pack [sɪks/'pæk/] 13 13  
skate (n) [skæt] 94 26  
skate (v) [skæt] 97 9  
skein [ski:n] 101 24  
ski [ski:] 95 17  
ski boot [ski/'bʊt/] 95 15  
ski cap [ski/'kæp/] 19 16  
ski lift [ski/'lɪft/] 95 18  
ski slope [ski/'slɒp/] 95  
skier [ski:'ɜ:] 94 35  
skin [ski:n] 9 37b  
skirt [ski:rt] 21 36  
skis [ski:z] 94 33  
skunk [skiŋk] 70 8  
skycap [ski/'kæp] 58 5  
slacks [slæks] 20 4  
sleeper [sli:p/'ɜ:] 35 19  
sleeping bag [sli:p/'piŋ bæg/] 89 26  
sleepwear [sli:p/'wɛr/] 22  
slice (n) [slɪs] 13 21  
slice (v) [slɪs] 33 10  
slide [slɪd] 87 12  
slide projector [slɪd prɔ 'jɛk'tɔ:]  
100 13  
slides [slɪdz] 100 12  
sling [slɪŋ] 43 3  
slippers [sli:p/'ɜ:z] 22 18  
slippery when wet  
[slɪp/'ə ri wɛn wɛt] 53 29

- slug [slūg] 64 4  
 small [smöl] 24 7  
 smoke [smök] 46 12  
 smoke detector [smök/ də tɛk/tər] 35 15  
 smokestack [smök/stāk/] 80 22  
 snacks [snāks] 15 18  
 snail [snāl] 64 1  
 snap [snāp] 101 13  
 sneakers [snē/kærz] 20 11  
 snorkel [snör/kəl] 91 34  
 snowmobile [snō/mōbēl] 52 8  
 snowplough [snō/plow/] 52 9  
 snowy [snō/ē] 26 3  
 soap [sōp] 36 15  
 soap dish [sōp/ dīsh/] 36 6  
 soccer [sök/ər] 92  
 soccer ball [sök/ər bōl/] 92 27  
 socks [söks] 22 17  
 sofa [sō/fə] 30 25  
 soft drink [sōft/ drīngk/] 16 11  
 softball [sōft/bōl/] 92, 92 10  
 solar collector [sō/lər kə lɛk/tər] 80 17  
 solar eclipse [sō/lər i klīps/] 79 10  
 solar system [sō/lər sīs/təm] 79  
 sole [söl] 20 6  
 solid [söl/əd] 24 20  
 solid figures [söl/əd fīg/yərz] 61  
 son [sūn] 3 16  
 Sony Walkman™ [sō/nē wök/mən] 100 30  
 sore throat [sör/ thrōt/] 44 12  
 south [sowth] 73 72  
 South America [sowth/ ə mēr/ə kə] 72 2  
 South Atlantic [sowth/ ät län/ tək] 72 12  
 South China Sea [sowth/ chī/nə sē/] 72 39  
 South Pacific [sowth/ pə sif/ik] 72 10  
 space shuttle [spās/ shūt əl] 79 29  
 spaghetti [spə gèt/ē] 18 10  
 spaniel [spän/yəl] 71 24  
 spare ribs [spēr/ rībz/] 10 10  
 spare tire [spēr/ tīr/] 55 39  
 sparrow [spār/ō] 66 10  
 spatula [späch/ə lə] 29 21  
 speaker [spē/kər] 30 21, 100 24  
 Speaker of the House [spē/kər əv dhə hōws] 78 5  
 speed limit sign [spēd/ līm ət sīn/] 53 30  
 speedometer [spə dōi /ə tər] 54 10  
 spider [spī/dər] 65 16  
 spinach [spīn/əch] 6 8  
 spinal cord [spī/nəl kōrd/] 5 58  
 spiral notebook [spī/rəl nōt/bōök] 59 15  
 split [splīt] 11 17  
 split-level house [splīt lev əl hōws] 28 7  
 sponge [spünj] 36 7  
 sponge (mop refill) [spünj/ mōp/ rē/fil] 37 12  
 sponge mop [spünj/ mōp/] 37 6  
 (spool of) thread [spōöl/ əv thrēd/] 101 2  
 spoon [spōön] 31 8  
 sports [spörts] 92–97  
 sports car [spörts/ kār/] 53 16  
 spotlight [spöt/līt/] 99 4  
 sprain [sprān] 44 13  
 spray can [sprā/ kən/] 13 24  
 spray starch [sprā/ stärch/] 25 12  
 spread [sprēd] 17 11  
 spring [sprīng] 27  
 sprinkler [sprīng/klər] 29 13, 87 14  
 square [skwēr] 61 9  
 squid [skwīd] 64 5  
 squirrel [skwūr/əl] 68 10  
 stage [stāj] 99 5  
 staircase [stēr/kās] 30 12  
 stake [stāk] 89 30  
 stamp [stämp] 50 10  
 stands [stāndz] 93 10  
 staple remover [stāp/əl rə mōō/vər] 83 29  
 stapler [stāp/lər] 83 27  
 star [stär] 79 4  
 starfish [stär/fīsh/] 64 7  
 starting gate [stär/tīng gāt/] 95 20  
 station [stā/shən] 57 18  
 station wagon [stā/shən wäg/ən] 54  
 steak [stāk] 10 5, 11 29, 18 21  
 steam [stēm] 33 12  
 steamer [stēm/ər] 32 3  
 steering wheel [stīr/īng wēl/] 54 8  
 stem [stēm] 8 2a, 62 1a  
 step [stēp] 30 13  
 step ladder [stēp/lād/ər] 37 1  
 stereo cassette player [stēr/ē ō kə sēt plā/ər] 100 25  
 stereo system [stēr/ē ō sīs/təm] 30 20  
 stethoscope [stēth/ə sköp/] 43 9  
 stewing meat [stōō/īng mēt] 10 4  
 stick [stīk] 12 5  
 stick shift [stīk/ shift/] 54 24  
 sting [stīng] 65 8a  
 stingray [stīng/rā/] 67 6  
 stir [stür] 33 1  
 stitch [stīch] 101 19  
 stitches [stīch/əz] 43 21  
 stockings [stök/īngz] 22 6  
 stomach [stüm/ək] 5 66  
 stomachache [stüm/ək äk/] 44 7  
 stopped-up toilet [stōpt/ ūp/ toy/lət] 40 6  
 stopper [stöp/ər] 36 10  
 stork [störk] 66 30  
 stove [stōv] 32 30  
 straight line [strāt/ līn/] 61 1  
 straw [strö] 16 10  
 strawberry [strö/bēr/ē] 8 15  
 strawberry shortcake [strö/bēr/ē shört/käk] 18 26  
 stream [strēm] 88 6  
 street [strēt] 49 31  
 street sign [strēt/ sīn/] 48 8, 49  
 streetcar [strēt/kār/] 57 30  
 streetlight [strēt/līt/] 49 29  
 stretch [strēch] 95 19  
 stretcher [strēch/ər] 43 12  
 string [strīng] 50 20, 98 10a  
 string bean(s) [strīng/ bēn(z)/] 6 15  
 (string of) beads [strīng/ əv bēdz/] 23 7  
 strings [strīngz] 98  
 striped [stript] 24 17  
 stroller [strö/lər] 35 14  
 student [stōō/dənt] 59 19

- stuffed animal [stüft/än/ə məl] 35 27
- subject [süb/jəkt] 51 10
- subway [süb/wā/] 56
- subway station [süb/wā stā/shən] 48 16
- sugar (packet) [shōög/ər pāk/ət] 16 13
- sugar bowl [shōög/ər bōl/] 31 23
- sugarcane [shōög/ər kān/] 62 20
- suitcase [sōot/kās/] 58 7
- summer [süm/ər] 27
- sun [sün] 79 7, 80 3
- sunbather [sün/bā/dhər] 90 19
- sundae [sün/dē] 18 23
- sunflower [sün/flow/ər] 62 19
- sunglasses [sün/glās/əz] 90 14
- sunny [sün/ē] 26 4
- (sunnyside-up) egg [sün/ē sīd ūp/ ěg/] 18 32
- sunroof [sün/rōōf/] 55 44
- suntan lotion [sün/tān lō/shən] 91 39
- supermarket [sōō/pər mār/kət] 14
- surf [sürf] 97 12
- surfboard [sürf/börd/] 91 25
- surgery [sür/jə rē] 45 2
- suspect [sūs/pĕkt] 47 3
- swan [swōn] 66 28
- sweatband [swēt/bānd/] 20 12
- sweater [swēt/ər] 19 7, 19 13, 19 23
- sweatpants [swēt/pānts/] 20 10
- sweatshirt [swēt/shürt/] 20 8
- sweep [swĕp] 42 7
- swimmer [swim/ər] 91 28
- swing [swīng] 35 24
- swings [swīngz] 87 16
- switch [swīch] 39 43c
- switchboard [swīch/börd/] 83 3
- switchboard operator [swīch/börd ōp/ə rā tər] 83 1
- swordfish [sörd/fīsh/] 67 3
- synthesizer [sīn/thə sī/zər] 99 21
- syringe [sə rīnj/] 43 27
- syrup [sīr/əp] 18 6
- T-shirt [tē/shürt/] 21 29
- table [tā/bəl] 31 7
- tablecloth [tā/bəl klōth/] 31 16
- tablet [tāb/lət] 45 6
- taco [tō/kō] 18 24
- tadpole [täd/pōl/] 67 16
- tail [tāl] 67 3a, 68 3a
- taillight [tāl/līt/] 54 31
- tailor [tā/lər] 84 6
- take [tāk] 17 10
- Takla Makan Desert [tōk/lə mə kōn/dēz/ərt] 73 53
- tambourine [tām/bə rēn/] 98 17
- tank top [tāngk/tōp/] 20 13
- tank truck [tāngk/trūk] 52 7
- tap [tāp] 16 20
- tape [tāp] 50 22
- tape measure [tāp/mēzh/ər] 38 21, 101 15
- taxi [tāk/sē] 57
- taxi stand [tāk/sē stānd/] 57 28
- taxicab [tāk/sē kāb/] 57 27
- tea [tē] 16 15
- teacher [tē/chər] 59 4
- teakettle [tē/kēt/əl] 32 28
- team sports [tēm/spōrts/] 92
- teapot [tē/pōt/] 31 19
- tear [tēr] 60 9
- teddy bear [tēd/ē bĕr/] 35 3
- tee [tē] 95 13
- telephone [tēl/ə fōn/] 83 15
- telescope [tēl/ə skōp/] 79 22
- television [tēl/ə vīzh/ən] 30 18, 100 5
- teller [tēl/ər] 86 15
- temperature [tēm/pər ə chər] 26 6
- temperature selector [tēm/pər ə chər sə lĕk/tər] 25 5
- tennis [tĕn/əs] 94
- tennis ball [tĕn/əs bōl/] 94 1
- tennis court [tĕn/əs kōrt/] 95
- tent [tĕnt] 89 24
- tentacle [tĕn/tə kəl] 64 12a
- terminal [tūrm/ə nəl] 55 55
- termite [tūr/mīt] 65 11
- terrier [tĕr/ē ər] 71 25
- territories [tĕr/ə tōr ěz] 74
- (text)book [tĕkst/bōōk/] 59 26
- theatre [thē/ə tər] 99
- thermometer [thər mōm/ə tər] 26 5
- thermos [thür/məs] 88 14
- thigh [thī] 4 18, 11 19
- thimble [thīm/bəl] 101 21
- third (1/3) [thürd] 61 32
- third baseman [thürd/bās/mən] 93 4
- thorn [thörn] 62 18c
- thread [thrĕd] 39 42b, 101 2
- three-piece suit [thrĕ/pĕs sōot] 21 40
- (three-pronged) plug [thrĕ/prōngd plūg/] 39 43d
- throat [thrōt] 5 59
- through [thrōō] 103 1
- throw [thrō] 97 10
- thumb [thūm] 4 24
- thumbtack [thūm/tāk/] 59 25
- ticket [tīk/ət] 57 16, 58 4
- ticket window [tīk/ət wīn/dō] 57 19
- tie (n) [tī] 21 47
- tie (v) [tī] 60 12
- tie clip [tī/klīp/] 23 14
- tie pin [tī/pīn/] 23 13
- tiger [tī/gər] 70 2
- tight [tīt] 24 3
- tighten [tī/tən] 42 4
- tights [tīts] 19 14
- tile [tīl] 36 27
- timer [tī/mər] 93 19
- timetable [tīm/tā/bəl] 57 20
- tip [tīp] 57 22
- tire [tīr] 54 37
- tissues [tīsh/ōōz] 34 13
- title [tī/təl] 51 9
- to [tōō] 103 9
- toast [tōst] 18 34
- toaster [tōs/tər] 32 16
- toe [tō] 5 54
- toenail [tō/nāl/] 5 56
- toilet [toy/lət] 36 29
- toilet brush [toy/lət brūsh/] 36 31
- toilet paper [toy/lət pā/pər] 36 30
- toiletries [toy/lə trĕz]
- token booth [tō/kən bōōth/] 56 13
- tollbooth [tōl/bōōth/] 53 24
- tomato(es) [tə mā/tō(z)] 7 19
- tongue [tūng] 4 41

- tongue depressor [tʌŋg/ də prɛs/ər] 44 12a
- toolbox [tʊl/ bɒks/] 38 23
- toolshed [tʊl/ shɛd/] 29 28
- toonie [tʊ/ nɛ] 75 7
- tooth [tʊθ] 4 42
- toothache [tʊθ/ ək/] 44 9
- toothbrush [tʊθ/ brʊʃ/] 36 21
- toothless mammals [tʊθ/ ləs mām/ əlz] 68
- toothpaste [tʊθ/ pɑst/] 36 16
- toque [tʊk] 19 76
- tortoise [tɔr/ təs] 67 18
- tossed salad [tɔst/ 18 13
- touch [tʊtʃ] 60 2
- tow truck [tə/ trʊk] 52 5
- toward [tɔrd] 103 4
- towel rack [təw/ əl ræk/] 36 25
- townhouse [taʊn haʊs] 28 3
- toy chest [tɔi/ tʃɛst/] 35 29
- track [træk] 56 10, 94 32
- track and field [træk/ ənd fi:ld/] 94
- tractor [træk/ tər] 81 15
- traffic cop [tráf/ ək kɔp/] 48 10
- traffic light [tráf/ ək lit/] 49 21
- trailer [trā/ lər] 53 9
- train [trān] 57
- transcript [trān/ skri:pt] 47 15
- transfer [trāns/ fər] 56 4
- transformer [trāns fɔr/ mər] 80 25
- transmission towers [trānz mish/ ən təw/ ərz] 80 23
- transportation [trāns/ pər tɑ/ shən] 52
- trash basket [trāʃ/ bæs/ kæt] 48 15
- trash can [trāʃ/ kæn/] 87 11
- travel agent [trāv/ əl ə/ jənt] 84 4
- travel in space [trāv/ əl in spās] 79
- traveller [trāv/ ə lər] 58 3
- tray [trā] 16 33
- tray table [trā/ tɑ/ bəl] 58 22
- treatments [trɛt/ mɛnts] 45
- tree [tri:] 63 35
- trees [tri:z] 62
- triangle [tri/ əng/ gəl] 61 6
- tricycle [tri/ sɪ kəl] 52 15
- trim [tri:m] 27 8
- tripod [tri/ pɔd] 100 9
- trombone [trɒm bɒn/] 98 23
- trough [trɒf] 81 25
- trout [traʊt] 67 2
- trowel [traʊ/ əl] 29 27
- truck [trʊk] 52, 53 22
- trumpet [trʌm/ pət] 98 25
- trunk [trʌŋk] 55 40, 63 35b, 68 17a
- tub [tʊb] 12 6
- tuba [tʊ/ bə] 98 27
- tube [tʊb] 13 15, 91 29
- tulip [tʊ/ ləp] 62 1
- turkey [tʊr/ kɛ] 11 23, 66 20
- turn signal (lights) [tʊrn/ sig nəl lits] 55 50
- turn signal lever [tʊrn/ sig nəl lɛ/ vər] 54 11
- turnip [tʊr/ nəp] 7 34
- turnstile [tʊrn/ stɪl/] 56 12
- turntable [tʊrn/ tɑ/ bəl] 100 18
- turtle [tʊr/ təl] 67 12
- (turtleneck) sweater [tʊr/ təl nɛk swɛ/ tər] 19 13
- tusk [tʊsk] 68 17b
- TV antenna [tɛ/ vɛ ən tɛn/ ə] 29 3
- twig [twɪg] 63 33a
- two dollar coin [tʊ do/ lar kɔɪn] 75 7
- (two-door) sedan [tʊ/ dɔr sə dan/] 55
- two-story house [tʊ/ stɔr/ ɛ haʊs] 28 8
- type [ti:p] 60 10
- typewriter [ti:p/ ri/ tər] 83 10
- typing chair [ti/ piŋg tʃɛr/] 83 17
- typist [ti/ pəst] 83 6
- ukulele [yʊ/ kə lɑ/ lɛ] 98 3
- umbrella [ʊm brɛl/ ə] 20 24
- umpire [ʊm/ pi:r] 92 1, 93 17
- uncle [ʌŋg/ kəl] 3 3
- under [ʌn/ dər] 102 8
- underpants [ʌn/ dər pɑnts/] 22 3
- undershirt [ʌn/ dər ʃɜrt/] 22 1
- underwear [ʌn/ dər wɛr/] 22
- uniform [yʊ/ nə fɔrm/] 21 45, 92 9
- universe [yʊ/ nə vi:rs/] 79
- unload [ʌn/ lɔd] 25 b
- up [ʌp]
- upper arm [ʌp/ ər ərm/] 4 7
- Urals [yʊ/ ɔr/ əlz] 73 46
- uranium rods [yʊ/ ɔ rɑ/ nɛ əm rɔdz/] 80 15
- Uranus [yʊ/ ɔr/ ə nəs] 79 17
- usher [ʌʃ/ ər] 99 16
- utility pole [yʊ/ ɔ til/ ə tɛ pɔl] 80 26
- utility room [yʊ/ ɔ til/ ə tɛ rʊm] 37
- (V-neck) sweater [vɛ/ nɛk swɛt/ ər] 19 23
- vacuum [væk/ yʊm] 42 14
- vacuum cleaner [væk/ yʊm klɛ/ nər] 37 16
- van [væn] 53 23
- vase [vās] 30 6
- VCR (videocassette recorder) [vɛ/ sɛ ər/][vid/ ɛ ɔ kə sɛt/ rə kɔr/ dər] 100 4
- vegetables [vɛj/ tə bəlz] 6
- vehicles [vɛ/ ə kəlz] 52
- vein [vān] 5 68
- vendor [vɛn/ dər] 87 3
- vent [vɛnt] 54 21
- Venus [vɛ/ nəs] 79 12
- verbs [vɜrbz] 17, 25, 27, 33, 42, 60, 96
- vest [vɛst] 21 39
- video [vid/ ɛ ɔ] 100
- video camera [vid/ ɛ ɔ kɑm/ ə rə] 100 1
- videocassette (tape) [vid/ ɛ ɔ kə sɛt/ tɑp/] 100 3
- vine [vi:n] 63 42
- viola [vɛ/ ɔl/ ə] 98 8
- violet [vi/ ə lət] 62 16
- violin [vi/ ə lɪn/] 98 7
- visa [vis] 39 36
- visor [viz/ ər] 54 5
- volleyball [vɔl/ ɛ bɔl/] 92, 92 23
- vote [vɔt] 78 18
- voting booth [vɔ/ tiŋg bʊθ] 78 16
- waders [wɑ/ dərz] 88 10
- waist [wāst] 4 13
- waiter [wɑ/ tər] 16 5
- waitress [wɑ/ trəs] 16 2
- walk [wɔk] 60 8
- walker [wɔk/ ər] 35 23
- wall [wɔl] 30 3
- wall unit [wɔl/ yʊ/ nət] 30 19

- wall-to-wall carpeting  
[wöl/ tə wöl kār/pə tɪŋ] 30 15
- wallet [wöl/ət] 20 9
- walnut(s) [wöl/nət(s)] 9 29
- walrus [wöl/rūs] 70 11
- warm [wörm] 26 8
- warning [wör/nɪŋ] 37 28
- wash [wösh] 42 16
- washcloth [wösh/klöth/] 36 22
- washer [wösh/ər] 25 1, 39 40
- washing [wösh/ɪŋ] 25 17
- wasp [wösp] 65 20
- wastepaper basket  
[wäst/pā pər bās/kæt] 36 13
- watch [wöch] 23 10
- watch for children  
[wöch fər chɪl/drən] 49 34
- watchband [wöch/bänd/] 23 11
- water (n) [wöt/ər] 91 30
- water (v) [wöt/ər] 27 5
- water fountain [wöt/ər fəʊn/tən]  
87 19
- water glass [wöt/ər gläs/] 31 6
- watercress [wöt/ər krēs/] 6 5
- waterfall [wöt/ər föl] 80 11, 89 18
- watering can [wöt/ər ɪŋg kæn/]  
29 16
- watermelon [wöt/ər mēl/ən] 9 26
- wave [wāv] 91 24
- weather [wēdh/ər] 26
- weather forecaster  
[wēdh/ər fər/kāst ər] 86 1
- weaving [wē/vɪŋ] 101 30
- web [wēb] 65 15
- wedding ring [wē/dɪŋ rɪŋ/] 23 4
- west [wēst] 73 74
- western red lily [wēs/tərn rēd lɪl/ē]  
77 11
- wet [wēt] 26 15
- wet suit [wēt/ sūot/] 91 38
- whale [wāl] 70 9
- wheat [wēt/] 62 22
- wheat farm [wēt/ färm/] 81
- (wheat) field [wēt/ fēld/] 81 16
- wheelbarrow [wēl/bār/ō] 29 32, 82  
23
- wheelchair [wēl/chēr/] 43 2
- whistle [wɪs/əl] 90 5
- white garden lily [wīt gār/dən lɪl/ē]  
77 10
- white trillium [wīt trɪl/ē əm] 77 8
- whole [hōl] 11 27, 61 29
- whole (chicken) [hōl/ chɪk/ən]  
11 16
- wicket [wɪk/ət] 50 15
- width [wɪdθ] 61 35
- wife [wɪf] 2 4
- wild rose [wɪld rōz] 76 1
- willow [wɪl/ō] 63 31
- wind [wɪnd] 80 4
- windbreaker [wɪnd/brā/kər] 19 5
- windmill [wɪnd/mɪl/] 80 19
- window [wɪn/dō] 29 7, 50 15
- windpipe [wɪnd/pɪp/] 5 60
- windshield [wɪnd/shēld] 55 45
- windshield wiper [wɪnd/shēld wɪ/pər]  
54 6
- windy [wɪn/dē] 26 13
- wine [wɪn/] 16 19
- wine glass [wɪn/ gläs/] 31 5
- wing [wɪŋ] 11 22, 65 4a, 66 1a
- winter [wɪn/tər] 27
- wipe [wɪp] 42 5
- wire [wɪr] 39 35
- witness [wɪt/nəs] 47 13
- witness stand [wɪt/nəs stænd/] 47 18
- wolf [wōɒlf] 71 29
- woman [wōɒm/ən] 2 1
- wood [wōɒd] 38 4
- wood plane [wōɒd/ plān/] 39 32
- woodpecker [wōɒd/pək/ər] 66 17
- woods [wōɒdz] 89 32
- woodwinds [wōɒd/wɪndz/] 98
- wool [wōɒl] 101 23
- word processor [wörd/ prō/sēs ər]  
83 7
- work gloves [wüerk/ glüvz/] 29 26
- workbench [wüerk/bēnch/] 38 22
- workshop [wüerk/shöp/] 38
- world [würl] 72-73
- worm [würm] 64 11
- wrench [rēnch] 38 10
- wrist [rɪst] 4 21
- write [rɪt] 60 7
- writer [rɪ/tər] 86 7
- X-ray [ɛks/rā/] 43 1
- X-ray screener [ɛks/rā skrē/nər]  
58 11
- xylophone [zɪ/lə fōn/] 98 31
- yam [yām] 7 24
- Yangtze River [yāŋ/sē rɪv/ər]  
73 69
- yarn 101 31
- Yellow Sea [yēl/ō sē/] 72 37
- Yenisey River [yēn/ə sā/ rɪv/ər]  
73 65
- Yukon River [yōɒ/kōn rɪv/ər] 73  
56
- Yukon Territory  
[yōɒ/kōn tēr/ə tər ē] 74 11
- zebra [zē/brə] 68 18
- zinnia [zɪn/ē ə] 62 13
- zipper [zɪp/ər] 101 16
- zoo [zōɒ] 87 1
- zucchini [zōɒ kē/nē] 7 27
- wrench [rēnch] 38 10
- wrist [rɪst] 4 21
- write [rɪt] 60 7
- writer [rɪ/tər] 86 7
- X-ray [ɛks/rā/] 43 1
- X-ray screener [ɛks/rā skrē/nər]  
58 11
- xylophone [zɪ/lə fōn/] 98 31
- yam [yām] 7 24
- Yangtze River [yāŋ/sē rɪv/ər]  
73 69
- yarn [yärn] 101 31
- Yellow Sea [yēl/ō sē/] 72 37
- Yenisey River [yēn/ə sā/ rɪv/ər]  
73 65
- Yukon River [yōɒ/kōn rɪv/ər] 73 5
- Yukon Territory  
[yōɒ/kōn tēr/ə tər ē] 74 11
- zebra [zē/brə] 68 18
- zinnia [zɪn/ē ə] 62 13
- zipper [zɪp/ər] 101 16
- zoo [zōɒ] 87 1
- zucchini [zōɒ kē/nē] 7 27